

Typical UL489 Application Power Circuit of a UL508A Panel

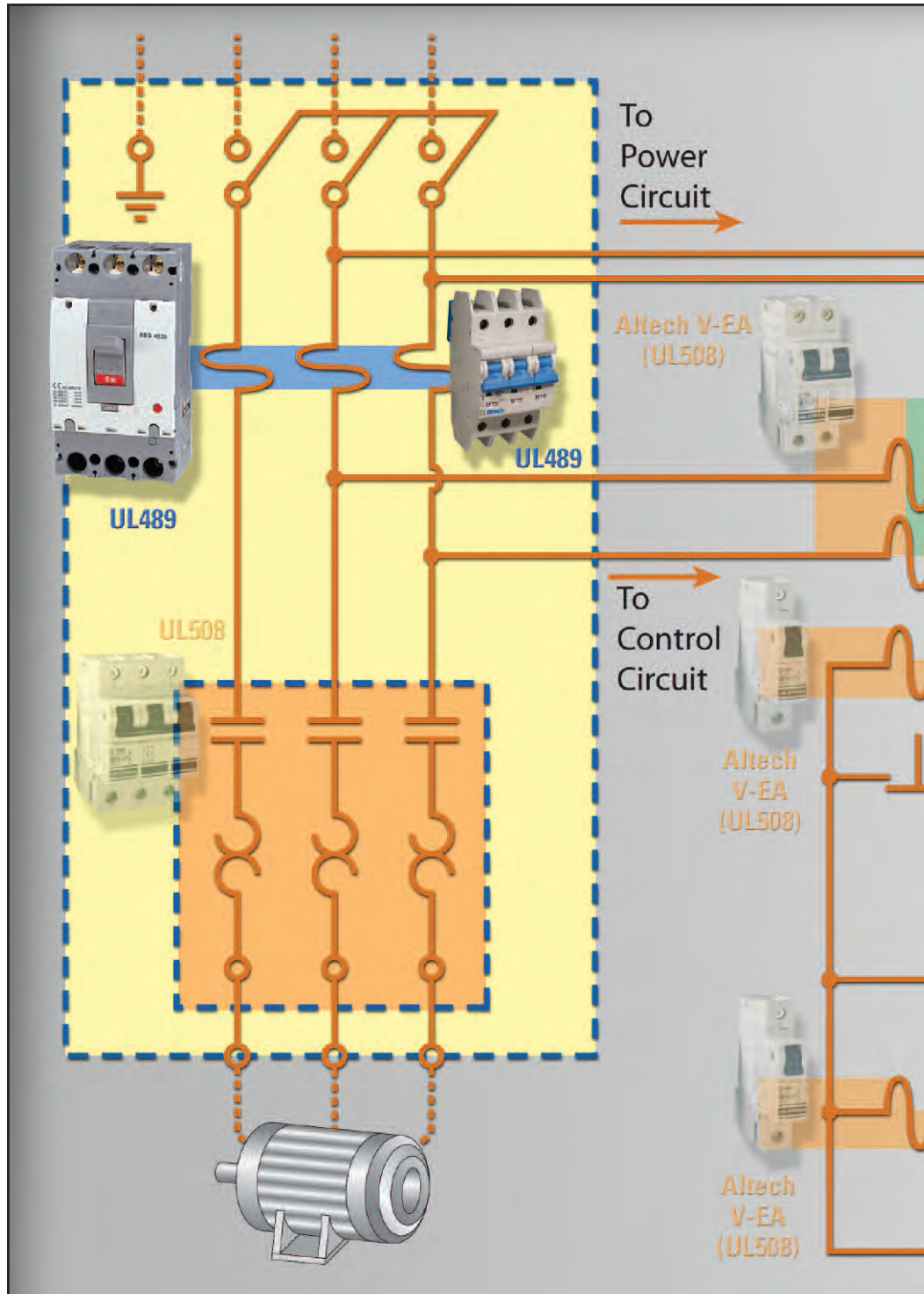

Disclaimer: This is an application example. Installation should be done by a qualified electrician under the guidance of UL specifications..

L-Series AC or DC Miniature Molded Case Circuit Breakers



UL489 Listed Circuit Breakers

- Available in AC and DC models
- DIN Rail Mounted
- 17.5mm width
- Thermal Magnetic
- 240V, 480Y/277V AC, 50/60Hz
- 125VDC (1 pole); 250VDC (2pole)
- 10kA Short Circuit Interrupting Capacity
- Positive Trip indicator (Green - off/tripped, Red - on)
- HACR Type 40°C
- Line/Load reversible

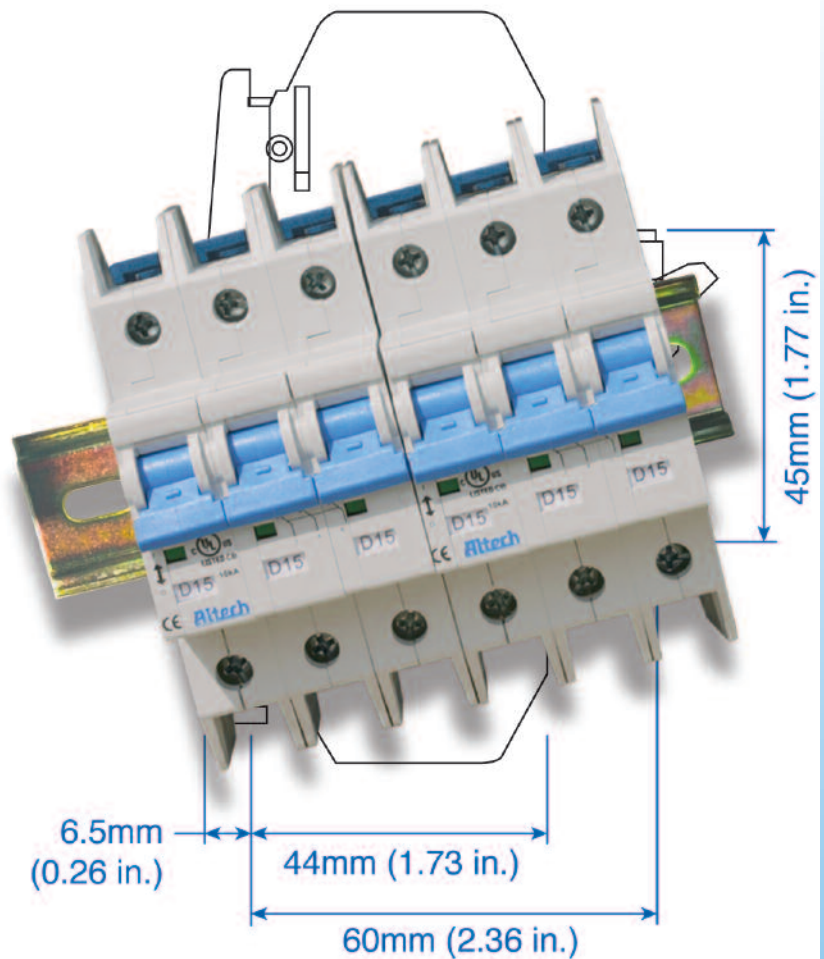

AC Version Current/ Voltage Rating	0.2-63A/240VAC, 0.2-32A/480Y/277VAC*
DC Version Current/ Voltage Rating	0.2-63A/125/250VDC
Calibration Temperature	40°C (104°F)
Operating Temperature	-25° to 60°C (-13° to 140°F)
Storage Temperature	-25° to 75°C (-13° to 167°F)
Terminal Size Acceptability and Torque	14-3 AWG: 17.5 lb-in. (2.0 Nm) 18-16 AWG: 25 lb-in. (2.8 Nm)
Terminal Protection Degree	IP20
Electrical Life	6000 cycles on/off
Mechanical Life	100000 cycles on/off
Wire Connection	copper wire only 60/75°C

*One device dual voltage ratings.

AC - SHORT CIRCUIT INTERRUPTING RATING

No. Poles	Type	0.2-32A	33-63A
1	AC	10kA@120, 240, 277V	10kA@120, 240V
2-4	AC	10kA@120, 240V, 480Y/277V	10kA@120, 240V

DC - SHORT CIRCUIT INTERRUPTING RATING

No. Poles	Type	0.2-32A	33-63A
1	DC	10kA@125V	10kA@125V
2	DC	10kA@250V	10kA@250V

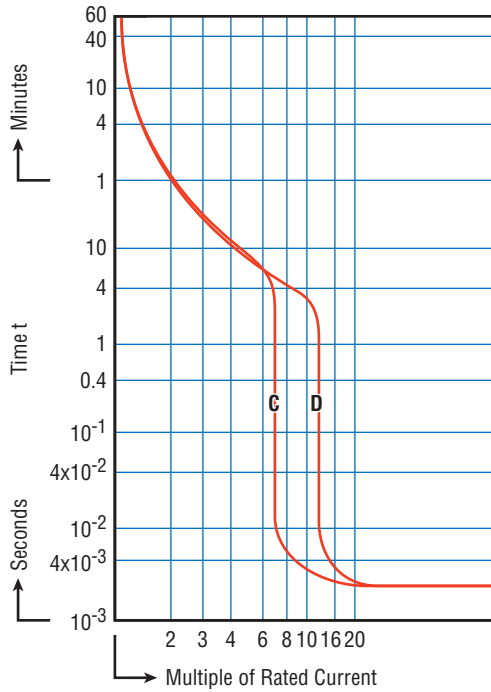

Time versus Current Trip Curve

For the exact trip curve, please refer to page 56.

Dimensions in mm side view

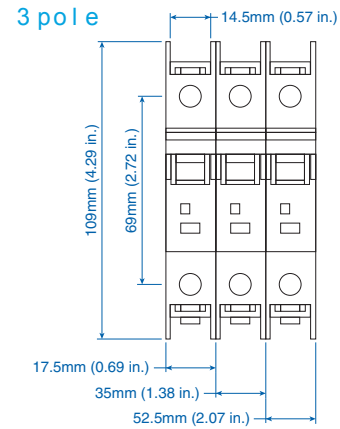
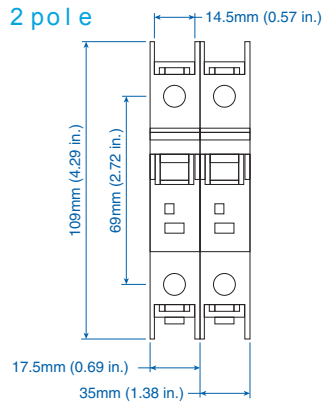
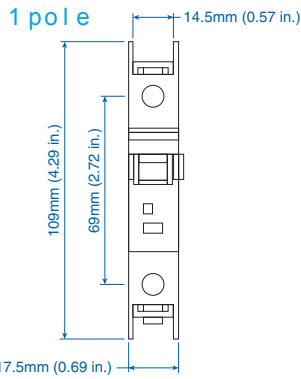
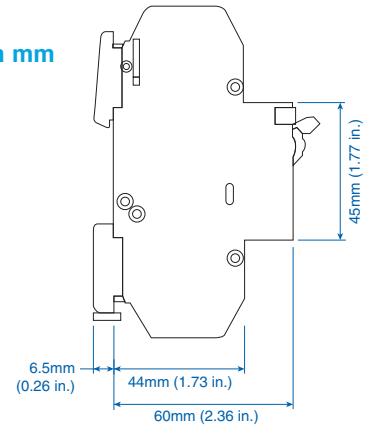

Trip-Characteristics*				Type	Applications						
Characteristic Trip Boundaries					Lighting Wiring Protection Control Circuits	Business Equipment Appliances	Transformers	Power Supplies Heaters	Motors		Reactive Load
Thermal Trip		Magnetic Trip							Low Inrush	High Inrush	
Must not Trip > 100ms	Must Trip < 1hr	Must not Trip > 100ms	Must Trip at 100ms								
C-Characteristics											
1.05xRC	1.3xRC	5xRC	10xRC	AC							
1.05xRC	1.3xRC	5xRC	10xRC	DC							
D-Characteristics											
1.05xRC	1.3xRC	10xRC	16xRC	AC							
1.05xRC	1.3xRC	10xRC	16xRC	DC							

*The value of each characteristic is shown vertically beneath its corresponding heading.



Warning!

This information should only be used as a selection guide. The use of a Miniature Circuit Breaker in an application with a certain Trip-Characteristic always requires prototype testing! It is the responsibility of the circuit design engineer to select the appropriate Miniature Circuit Breaker for his specific application.

AC C-Trip Characteristics



LISTED
E305318

Application Examples:
Low inrush motors, resistive loads, wiring protection, receptacles, lighting, and control circuit applications. Relatively short thermal trip delay and medium magnetic trip point.



One Pole

Rated Current	Type/ Cat. No.
0.2A	1CU02L
0.5A	1CU05L
1.0A	1CU1L
1.6A	1CU1.6L
2.0A	1CU2L
3.0A	1CU3L
4.0A	1CU4L
5.0A	1CU5L
6.0A	1CU6L
8.0A	1CU8L
10A	1CU10L
12A	1CU12L
13A	1CU13L
15A	1CU15L
16A	1CU16L
20A	1CU20L
25A	1CU25L
30A	1CU30L
32A	1CU32L
40A	1CU40L
50A	1CU50L
60A	1CU60L
63A	1CU63L

Standard Pack: 12

Weight: 1.7kg (3.74 lb.)



Two Pole

Rated Current	Type/ Cat. No.
0.2A	2CU02L
0.5A	2CU05L
1.0A	2CU1L
1.6A	2CU1.6L
2.0A	2CU2L
3.0A	2CU3L
4.0A	2CU4L
5.0A	2CU5L
6.0A	2CU6L
8.0A	2CU8L
10A	2CU10L
12A	2CU12L
13A	2CU13L
15A	2CU15L
16A	2CU16L
20A	2CU20L
25A	2CU25L
30A	2CU30L
32A	2CU32L
40A	2CU40L
50A	2CU50L
60A	2CU60L
63A	2CU63L

Standard Pack: 6

Weight: 1.7kg (3.74 lb.)



Three Pole

Rated Current	Type/ Cat. No.
0.2A	3CU02L
0.5A	3CU05L
1.0A	3CU1L
1.6A	3CU1.6L
2.0A	3CU2L
3.0A	3CU3L
4.0A	3CU4L
5.0A	3CU5L
6.0A	3CU6L
8.0A	3CU8L
10A	3CU10L
12A	3CU12L
13A	3CU13L
15A	3CU15L
16A	3CU16L
20A	3CU20L
25A	3CU25L
30A	3CU30L
32A	3CU32L
40A	3CU40L
50A	3CU50L
60A	3CU60L
63A	3CU63L

Standard Pack: 4

Weight: 1.7kg (3.74 lb.)

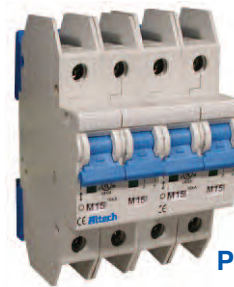

Four Pole
Please contact
Altech.



For ring tongue terminal version, replace "U" with "R" in part number. For example **1CR20L** instead of **1CU20L**.

AC D-Trip Characteristics



Application Examples:
 High inrush motors, transformers, power supplies, heaters and reactive loads.
 Relatively long thermal trip delay and very high magnetic trip point.



One Pole

Rated Current	Type/ Cat. No.
0.2A	1DU02L
0.5A	1DU05L
1.0A	1DU1L
1.6A	1DU1.6L
2.0A	1DU2L
3.0A	1DU3L
4.0A	1DU4L
5.0A	1DU5L
6.0A	1DU6L
8.0A	1DU8L
10A	1DU10L
12A	1DU12L
13A	1DU13L
15A	1DU15L
16A	1DU16L
20A	1DU20L
25A	1DU25L
30A	1DU30L
32A	1DU32L
40A	1DU40L
50A	1DU50L
60A	1DU60L
63A	1DU63L

Standard Pack: 12

Weight: 1.7kg (3.74 lb.)



Two Pole

Rated Current	Type/ Cat. No.
0.2A	2DU02L
0.5A	2DU05L
1.0A	2DU1L
1.6A	2DU1.6L
2.0A	2DU2L
3.0A	2DU3L
4.0A	2DU4L
5.0A	2DU5L
6.0A	2DU6L
8.0A	2DU8L
10A	2DU10L
12A	2DU12L
13A	2DU13L
15A	2DU15L
16A	2DU16L
20A	2DU20L
25A	2DU25L
30A	2DU30L
32A	2DU32L
40A	2DU40L
50A	2DU50L
60A	2DU60L
63A	2DU63L

Standard Pack: 6

Weight: 1.7kg (3.74 lb.)



Three Pole

Rated Current	Type/ Cat. No.
0.2A	3DU02L
0.5A	3DU05L
1.0A	3DU1L
1.6A	3DU1.6L
2.0A	3DU2L
3.0A	3DU3L
4.0A	3DU4L
5.0A	3DU5L
6.0A	3DU6L
8.0A	3DU8L
10A	3DU10L
12A	3DU12L
13A	3DU13L
15A	3DU15L
16A	3DU16L
20A	3DU20L
25A	3DU25L
30A	3DU30L
32A	3DU32L
40A	3DU40L
50A	3DU50L
60A	3DU60L
63A	3DU63L

Standard Pack: 4

Weight: 1.7kg (3.74 lb.)

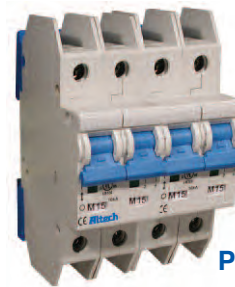

Four Pole
 Please contact
 Altech.



For ring tongue terminal version, replace "U" with "R" in part number. For example **1CR20L** instead of **1CU20L**.

DC C- & D-Trip Characteristics

Application Examples:
Telecommunication equipment, computer equipment, uninterruptable power supplies.



LISTED
E305318

C-Trip



One Pole

Rated Current	Type/ Cat. No.
0.2A	DC1CU02L
0.5A	DC1CU05L
1.0A	DC1CU1L
1.6A	DC1CU1.6L
2.0A	DC1CU2L
3.0A	DC1CU3L
4.0A	DC1CU4L
5.0A	DC1CU5L
6.0A	DC1CU6L
8.0A	DC1CU8L
10A	DC1CU10L
12A	DC1CU12L
13A	DC1CU13L
15A	DC1CU15L
16A	DC1CU16L
20A	DC1CU20L
25A	DC1CU25L
30A	DC1CU30L
32A	DC1CU32L
40A	DC1CU40L
50A	DC1CU50L
60A	DC1CU60L
63A	DC1CU63L

Standard Pack: 12

Weight: 1.7kg (3.74 lb.)



Two Pole

Rated Current	Type/ Cat. No.
0.2A	DC2CU02L
0.5A	DC2CU05L
1.0A	DC2CU1L
1.6A	DC2CU1.6L
2.0A	DC2CU2L
3.0A	DC2CU3L
4.0A	DC2CU4L
5.0A	DC2CU5L
6.0A	DC2CU6L
8.0A	DC2CU8L
10A	DC2CU10L
12A	DC2CU12L
13A	DC2CU13L
15A	DC2CU15L
16A	DC2CU16L
20A	DC2CU20L
25A	DC2CU25L
30A	DC2CU30L
32A	DC2CU32L
40A	DC2CU40L
50A	DC2CU50L
60A	DC2CU60L
63A	DC2CU63L

Standard Pack: 6

Weight: 1.7kg (3.74 lb.)

D-Trip



One Pole

Rated Current	Type/ Cat. No.
0.2A	DC1DU02L
0.5A	DC1DU05L
1.0A	DC1DU1L
1.6A	DC1DU1.6L
2.0A	DC1DU2L
3.0A	DC1DU3L
4.0A	DC1DU4L
5.0A	DC1DU5L
6.0A	DC1DU6L
8.0A	DC1DU8L
10A	DC1DU10L
12A	DC1DU12L
13A	DC1DU13L
15A	DC1DU15L
16A	DC1DU16L
20A	DC1DU20L
25A	DC1DU25L
30A	DC1DU30L
32A	DC1DU32L
40A	DC1DU40L
50A	DC1DU50L
60A	DC1DU60L
63A	DC1DU63L

Standard Pack: 12

Weight: 1.7kg (3.74 lb.)



Two Pole

Rated Current	Type/ Cat. No.
0.2A	DC2DU02L
0.5A	DC2DU05L
1.0A	DC2DU1L
1.6A	DC2DU1.6L
2.0A	DC2DU2L
3.0A	DC2DU3L
4.0A	DC2DU4L
5.0A	DC2DU5L
6.0A	DC2DU6L
8.0A	DC2DU8L
10A	DC2DU10L
12A	DC2DU12L
13A	DC2DU13L
15A	DC2DU15L
16A	DC2DU16L
20A	DC2DU20L
25A	DC2DU25L
30A	DC2DU30L
32A	DC2DU32L
40A	DC2DU40L
50A	DC2DU50L
60A	DC2DU60L
63A	DC2DU63L

Standard Pack: 6

Weight: 1.7kg (3.74 lb.)



For ring tongue terminal version, replace "U" with "R" in part number. For example **1CR20L** instead of **1CU20L**.

L-Series Trip Curves

**C and D Trip
Less than 10A**

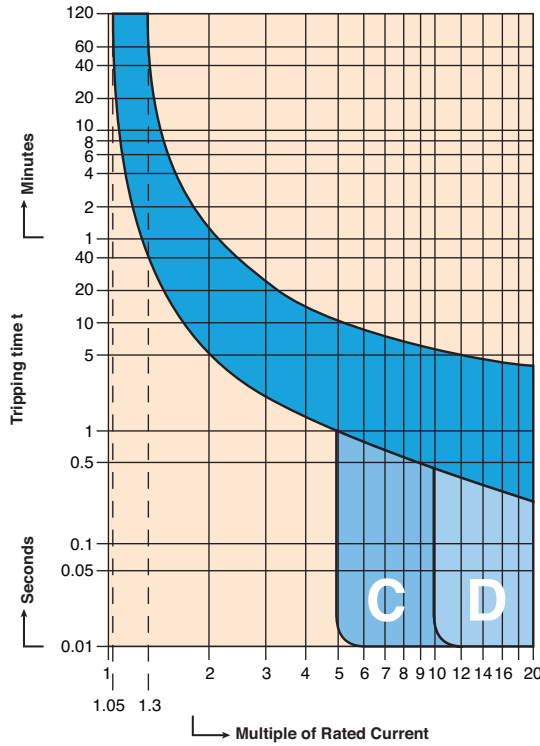

**C and D Trip
10A and higher**

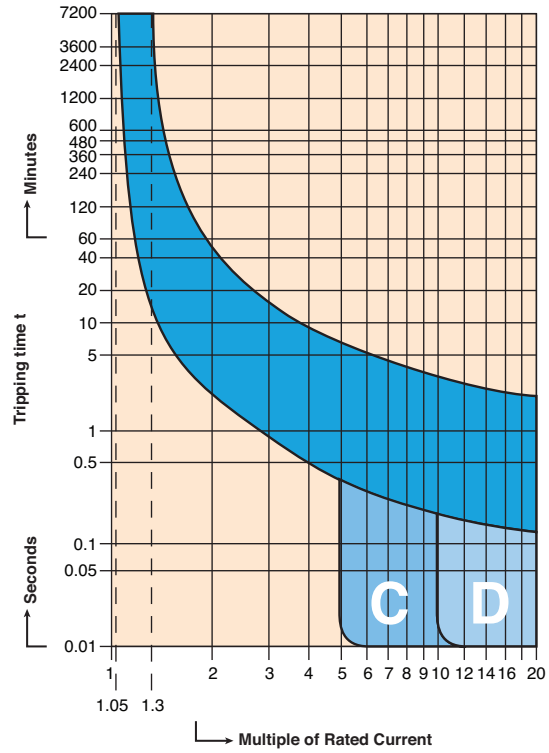

Temperature and Power Loss Specifications

Rated current I _n (A)	Effective rated current allowing for ambient temperature I _{cor} (A)									Internal impedance Z (m Ω) char. B, C, D, K	Power Loss B, C, D, K P (W)
	-20	-10	0	10	20	30	40	50	60		
0.2	0.24	0.24	0.23	0.22	0.21	0.2	0.19	0.18	0.17	45100.0	1.80
0.5	0.61	0.59	0.57	0.55	0.53	0.5	0.47	0.44	0.42	8000.0	2.00
1	1.21	1.18	1.14	1.1	1.05	1.0	0.93	0.88	0.83	2000.0	2.00
2	2.42	2.36	2.28	2.2	2.1	2.0	1.86	1.76	1.67	490.0	1.96
3	3.63	3.54	3.42	3.3	3.15	3.0	2.79	2.64	2.5	230.0	2.07
4	4.84	4.72	4.56	4.4	4.2	4.0	3.72	3.52	3.33	150.0	2.40
5	6.1	5.9	5.7	5.5	5.3	5.0	4.7	4.4	4.2	95.0	2.38
6	7.3	7.1	6.8	6.6	6.3	6.0	5.6	5.3	5.0	69.0	2.48
7	8.5	8.2	8.0	7.7	7.4	7.0	6.5	6.2	5.8	52.0	2.55
8	9.7	9.4	9.1	8.8	8.4	8.0	7.4	7.0	6.7	35.0	2.24
10	12.1	11.8	11.4	11.0	10.5	10.0	9.3	8.8	8.3	23.5	2.35
12	14.5	14.2	13.7	13.2	12.6	12.0	11.2	10.6	10.0	18.7	2.69
13	15.7	15.3	14.8	14.3	13.7	13.0	12.1	11.5	10.8	14.3	2.42
14	16.9	16.5	16.0	15.4	14.7	14.0	13.0	12.3	11.7	12.4	2.43
15	18.2	17.7	17.1	16.5	15.8	15.0	14.0	13.2	12.5	10.1	2.27
16	19.4	18.9	18.2	17.6	16.8	16.0	14.9	14.1	13.3	7.5	1.92
20	24.2	23.6	22.8	22.0	21.0	20.0	18.6	17.6	16.7	6.3	2.52
25	30.3	29.5	28.5	27.5	26.3	25.0	23.3	22.0	20.8	4.6	2.88
30	36.3	35.4	34.2	33.0	31.5	30.0	27.9	26.5	25.0	3.6	3.24
32	38.7	37.8	36.5	35.2	33.6	32.0	29.8	28.2	26.7	3.6	3.69
35	42.3	41.3	39.9	38.5	36.8	35.0	32.6	30.8	29.2	3.6	4.41
40	48.4	47.2	45.6	44.0	42.0	40.0	37.2	35.2	33.3	3.0	4.80
50	60.5	59.0	57.0	55.0	52.5	50.0	46.5	44.1	41.7	2.4	6.00
60	72.6	70.9	68.4	66.0	63.0	60.0	55.9	52.9	50.1	1.8	6.48

Accessories

L-Series Circuit Breakers



LISTED
E305318

Accessories can be factory or field mounted on L-Series miniature molded case circuit breakers for enhanced control and monitoring capabilities. Field mounting kits include all necessary parts and instructions. Accessories can be gang mounted on a single controller (the Auxiliary Switch in the outside position). The mounting arrangement links the internal latch-pins for the tripping mechanisms, ensuring simultaneous trips. Handles are linked to simplify manual resetting.



Neutral Pole (63A/240VAC; 32A/480Y/277VAC)

Description	Type/ Cat. No.	Cable Max	Cable Min	Torque Max	Torque Min
Neutral	ALTN2L	25mm ² 3 AWG	2.5mm ² 12 AWG	2Nm 17.5 lb-in	1.5Nm 12 lb-in

Standard Pack: 10

Weight: 1.2kg (2.64 lb.)



Shunt Trip

Shunt Trip and Undervoltage Trip

Description	Shunt Trip Type/Cat. No.	Operational Voltage	Rated Coil Current	Undervoltage Trip* Type/Cat. No.
AC Coil:				
12V AC	FA12ACL	8.4 - 13.2V	6A	UV12ACL
24V AC	FA24ACL	16.8 - 26.4V	2.8A	UV24ACL
48V AC	FA48ACL	33.6 - 52.8V	0.8A	UV48ACL
60V AC	FA60ACL	42 - 66V	~0.7A	UV60ACL
110V AC	FA110ACL	77 - 121V	0.5A	UV110ACL
120V AC	FA120ACL	84 - 132V	~0.5A	UV120ACL
230V AC	FA230ACL	161 - 253V	0.6A	UV230ACL
277V AC	FA277ACL	194 - 305V	~0.5A	UV277ACL
400V AC	FA400ACL	280 - 440V	0.5A	UV400ACL
DC Coil:				
12V DC	FA12DCL	8.4 - 13.2V	~6A	UV12DCL
24V DC	FA24DCL	16.8 - 26.4V	3A	UV24DCL
48V DC	FA48DCL	33.6 - 52.8V	2A	UV48DCL
110V DC	FA110DCL	77 - 121V	0.6A	UV110DCL

* Reset-Hold Voltage = 0.85 x V_E; Drop-Out Voltage = 0.2 x V_E

Standard Pack: 10

Weight: 1.1kg (2.43 lb.)

Terminal Size - min/max	2.5 mm ² (12 AWG) / 25mm ² (3 AWG)
Terminal Torque - min/max	1.5 Nm (12 lb. in.) / 2 Nm (17.5 lb. in.)



Undervoltage Trip

Auxiliary Contact (6A/120VAC; 3A/240VAC)

Description	Type/ Cat. No.	Cable Max	Cable Min	Torque Max	Torque Min
1 x CO	H1COL	2.5mm ² 12 AWG	0.5mm ² 20 AWG	0.5Nm 4 lb-in	0.33Nm 3 lb-in
2 x CO	H2COL				
1 x CO, 1 Signal & Test Button	HSTCOL				

Standard Pack: 15

Weight: 0.5kg (1.32 lb.)



Lock-out Adapter

Description	Type/ Cat. No.
Yellow	EASS2L

Standard Pack: 10

Weight: 50g (1.76 oz.)



Front Mounting Kit with hardware

Description	Type/ Cat. No.	Weight
1 Pole	FMA1PL	40g (1.41 oz.)
2 Pole	FMA2PL	45g (1.59 oz.)
3 Pole	FMA3PL	50g (1.76 oz.)

Standard Pack: 1

Altech UL489 Busbar System



UL489 recognized
E305318



UL489 Listed Busbars

The Altech Busbar System is an innovative way to jumper up to 57 poles of Miniature Molded Case Circuit Breakers (MMCCB).

The advantages of this busbar system are:

- 30% Installation time savings
- Panel space savings
- Reduced maintenance
- High electrical ratings

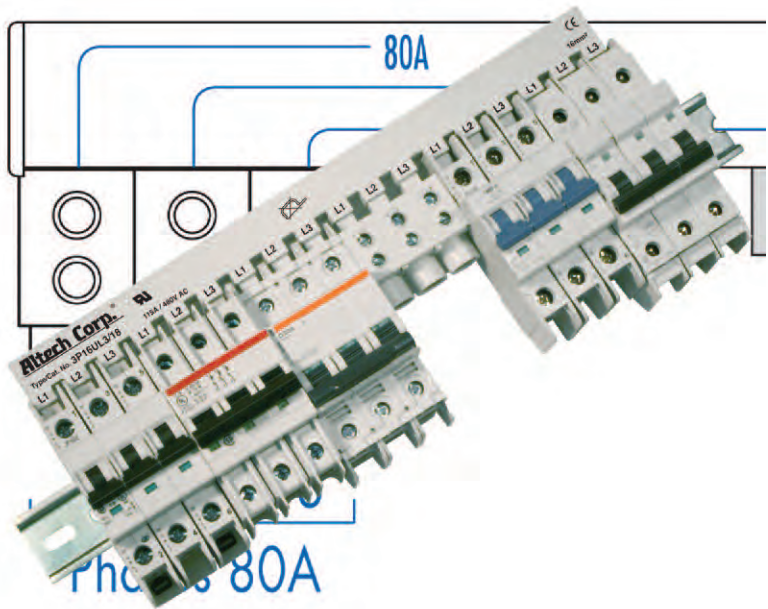

Universal UL489 Busbar fits most UL489 Miniature Circuit Breakers in the market!

Please contact Altech for details and further information.

UL489 Busbar System

- Every pin configuration is possible by combination of existing 6, 12 and 18 pin busbars.
- Power Feeding:
Power Feed Lug (115A), Direct Power Feed (115A)
- UL listed for Altech's L-Series of Miniature Circuit Breakers
- UL listed for use with most popular UL489 Miniature Circuit Breakers in the market.

Technical Specifications	Busbars UL489
Material of Busbar	Copper
Material of Insulation (Housing)	Polyamid
Electrical Ratings	115A/480VAC
Short Circuit Withstand Rating	10kA
Applying Standards	UL489, VDE0660 Part 100, IEC60749, DIN EN60947-1

Altech UL489 Busbar System

Power Feed Methods

End Feed Method

P35ULT*

With the **P35ULT** Power Feed Lug as a Start/End Feeding Device a maximum input current of **115A per Phase** can be achieved.

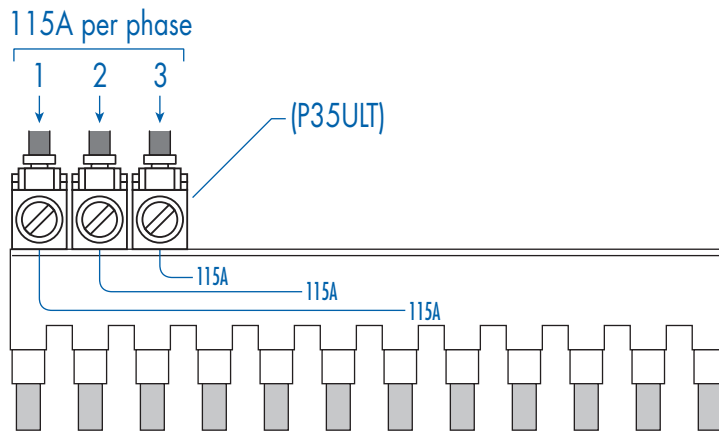

P50ULB*

With the **P50ULB** Modular Direct Power Feed as a Start/End Feeding Device a maximum input current of **115A per Phase** can be achieved.

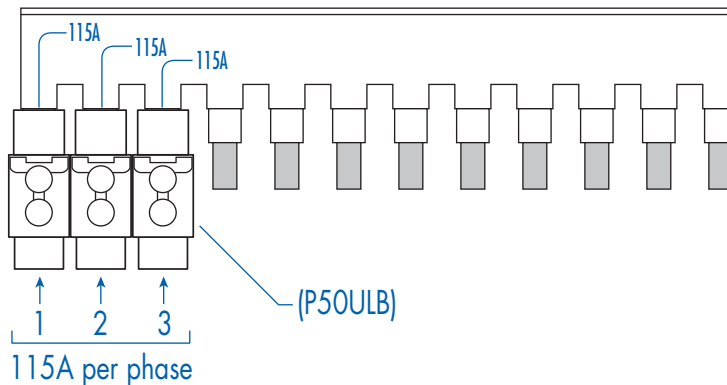

* For complete specifications and description of Feeding Devices see page 63.

1 PHASE BUSBAR

16mm² for 115A



Type/ Cat. No.	No. of Pins	Length [mm]
1P16UL3/6	6	99

UL489 recognized
E305318

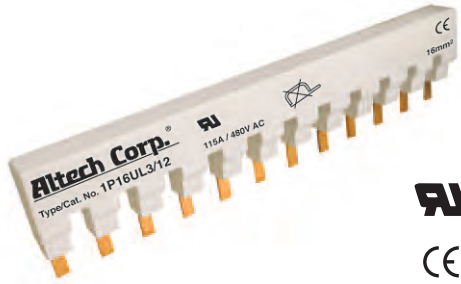
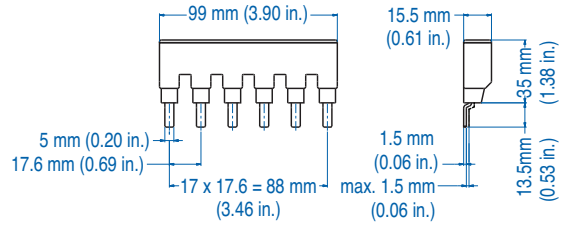

Type/ Cat. No.	No. of Pins	Length [mm]
1P16UL3/12	12	204.6

UL489 recognized
E305318

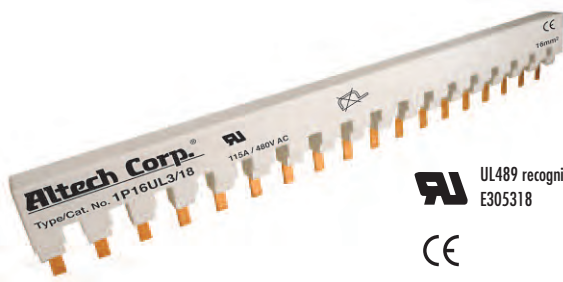
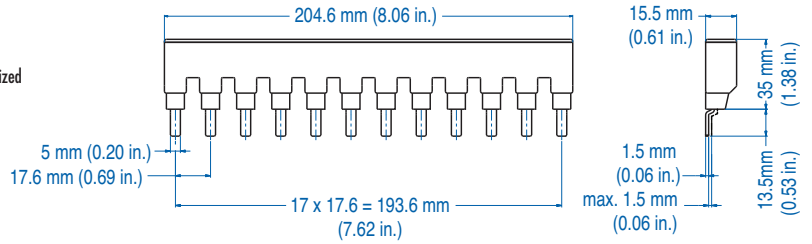

Type/ Cat. No.	No. of Pins	Length [mm]
1P16UL3/18	18	310.2

UL489 recognized
E305318

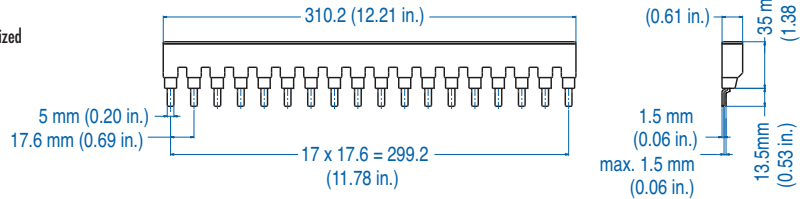

Example for different No. of Pins

eg. 44 pins use 1x 1P16UL3/12 + 2x 1P16UL3/18

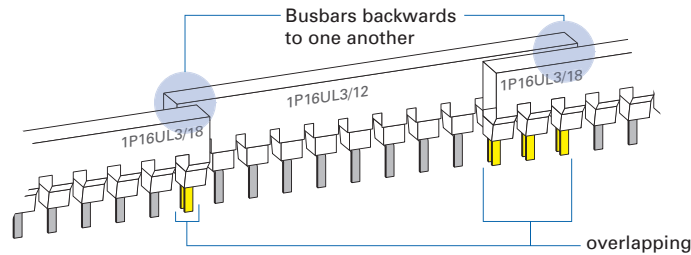

- No. of overlapping pins of 2 busbars must be a multiplier of the No. of phases
- Overlapping busbars are backwards to each other

ACCESSORIES



Type/Cat. No: **P35ULT**
Description: Power Feed Lug



Type/Cat. No: **P50ULB**
Description: Modular Direct Power Feed



Type/Cat. No: **BRUL (3 per strip)**
Description: Insulation Cap

2 PHASE BUSBAR

16mm² for 115A



UL489 recognized
E305318

CE

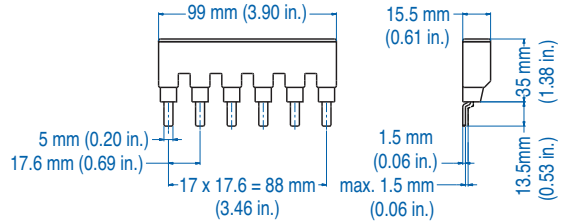

Type/ Cat. No.	No. of Pins	Length [mm]
2P16UL3/6	6	99

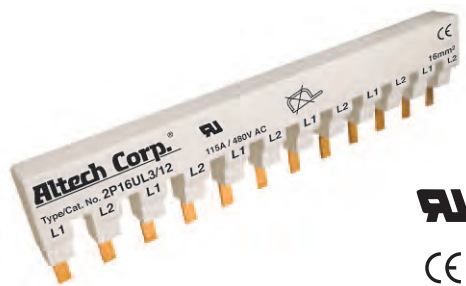

UL489 recognized
E305318

CE

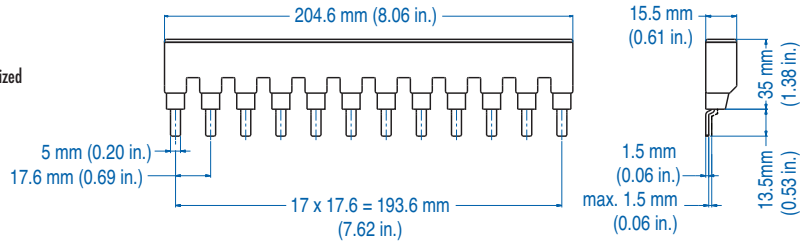

Type/ Cat. No.	No. of Pins	Length [mm]
2P16UL3/12	12	204.6

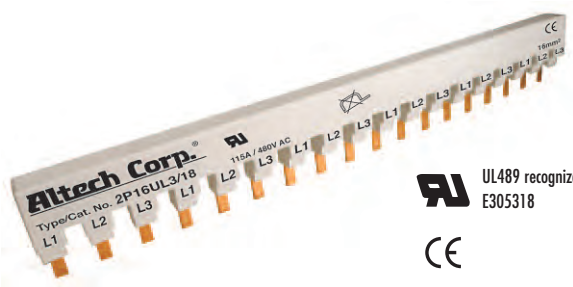

UL489 recognized
E305318

CE

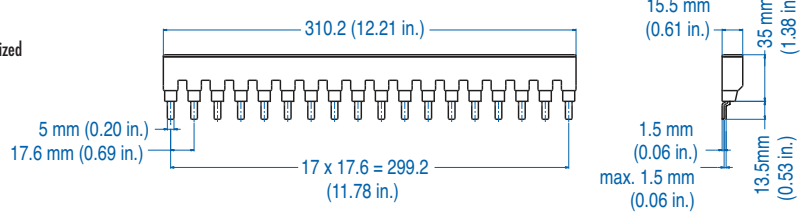

Type/ Cat. No.	No. of Pins	Length [mm]
2P16UL3/18	18	310.2

Example for different No. of Pins
eg. 30 pins use 3x 2P16UL3/12

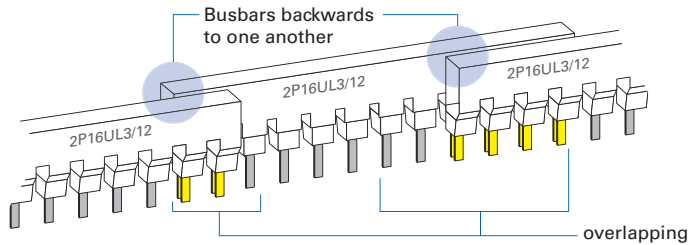

- No. of overlapping pins of 2 busbars must be multiplier of the No. of phases
- Overlapping busbars are backwards to each other

ACCESSORIES



Type/Cat. No: P35ULT
Description: Power Feed Lug



Type/Cat. No: P50ULB
Description: Modular Direct Power Feed



Type/Cat. No: BRUL (3 per strip)
Description: Insulation Cap

3 PHASE BUSBAR

16mm² for 115A



Type/
Cat. No.

No. of
Pins

Length
[mm]

3P16UL3/6 6 99



UL489 listed
E305318

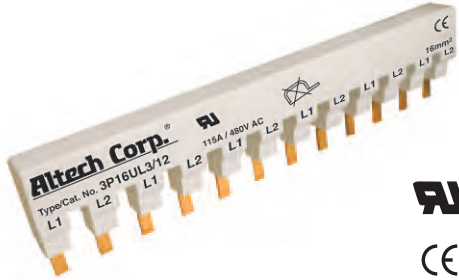
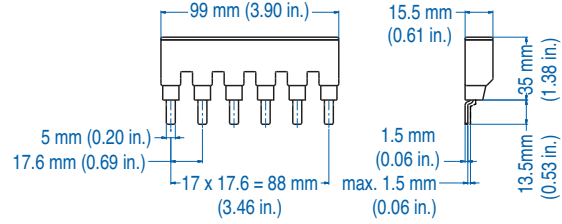

Type/
Cat. No.

No. of
Pins

Length
[mm]

3P16UL3/12 12 204.6



UL489 listed
E305318

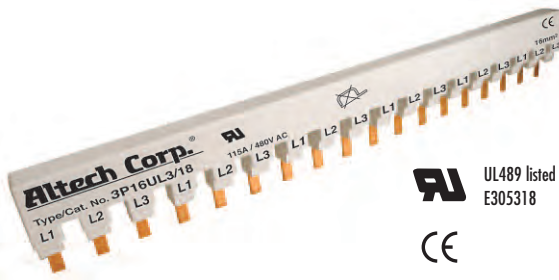
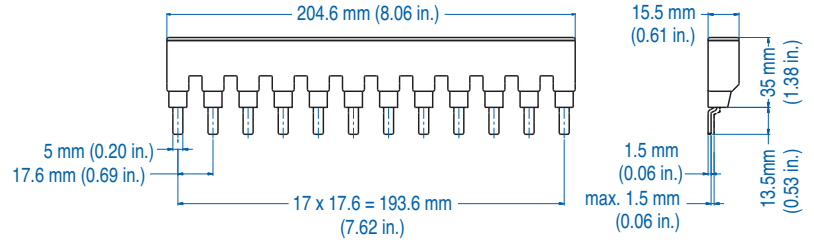

Type/
Cat. No.

No. of
Pins

Length
[mm]

3P16UL3/18 18 310.2



UL489 listed
E305318

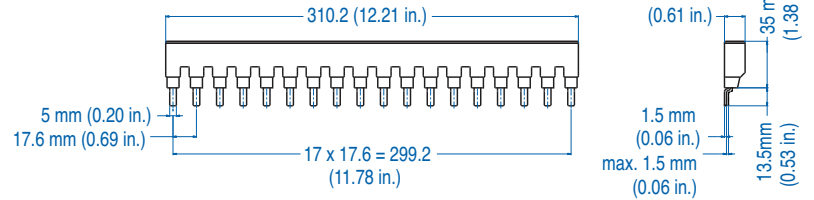

Example for different No. of Pins

eg. 39 pins use 1x 3P16UL3/12 + 2x 3P16UL3/18

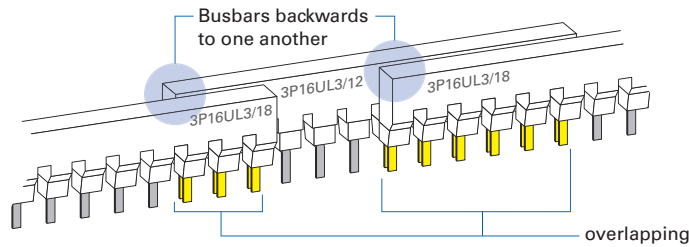

- No. of overlapping pins of 2 busbars must be multiplier of the No. of phases
- Overlapping busbars are backwards to each other

ACCESSORIES



Type/Cat. No:

P35ULT

Description:

Power Feed Lug



P50ULB

Modular Direct Power Feed



BRUL (3 per strip)

Insulation Cap

Power Feed Devices

Easy connection of power supply wires to the busbar/MCB. Power Feed Devices ensure permanent connection.

Power Feed Lug



UL UL489 listed
E305318
CE

Modular Direct Power Feed



UL UL489 listed
E305318
CE

Type/Cat. No.	P35ULT	P50ULB
Electrical Ratings	115A/480V AC	115A/480V AC
Conductors	75 C°	75 C°
Terminal Site Acceptability	14-2AWG(1.53mm ²)	14-1AWG(1.5-50mm ²)
Required Torque	4Nm (35.4 lb. in.)	3.5Nm/31 lb. in. (14-6AWG) 4Nm/35.4 lb. in. (4-1AWG)
Material of Lug	Brass	Brass
Insulation Material	Polyamid	Polyamid
For use with	UL489 1-3 phase Busbar	UL489 1-3 phase Busbar

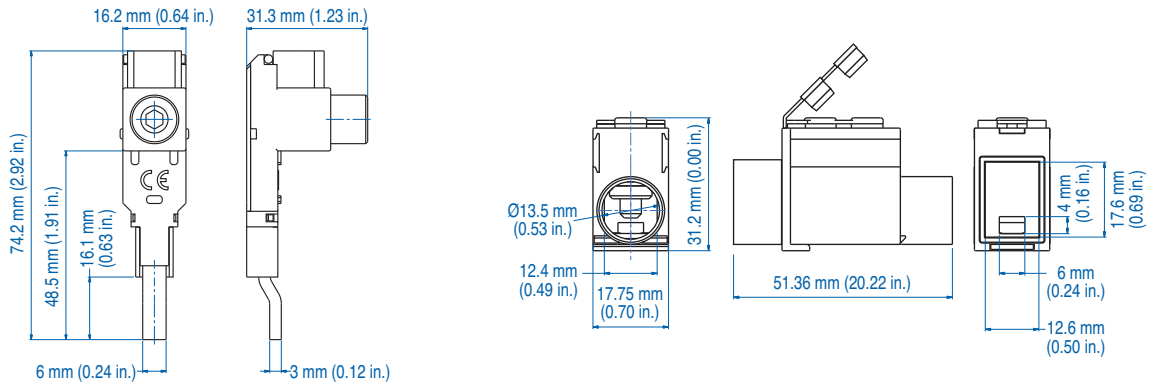

Assembly Instructions

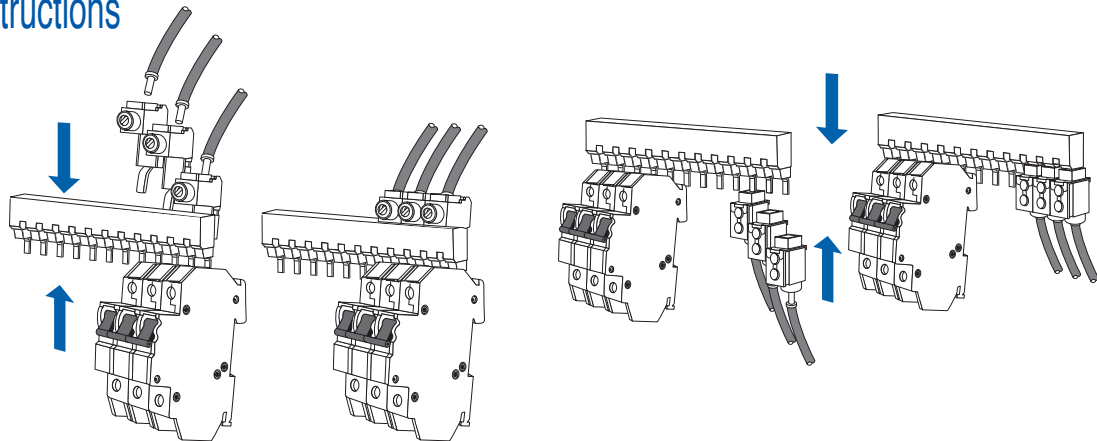

Miscellaneous Accessories

Insulation Caps



Type/Cat. No:	BRUL (3 per strip)
Description:	Insulation Cap

Altech Busbar Systems

Configuration and Assembly of UL489 Busbars

UL489 Busbars are available in 3 different Pin Configurations per Phase, (6, 12 and 18 Pins).

The UL489 busbar cannot be cut, since the creepage and clearance distance requirements from UL are too stringent. Therefore, to obtain the desired No. of Pins, Busbar-Pins can be overlapped as explained below:

- 1) Busbars are overlapped backwards to each other. Both Pins of each Busbar fit together in the terminals of the Miniature Circuit Breaker.
- 2) The Number of overlapping Pins of 2 Busbar must be a multiplier of the Number of Phases to keep existing Phase sequence. (Can be overlapped by more than the number of phases).
- 3) Any available combination of the 3 different Pin configurations is possible.
- 4) In most cases there is more than 1 combination possible.
- 5) For more possible configurations see Busbar Selection Table on page 21.

Configuration Examples*

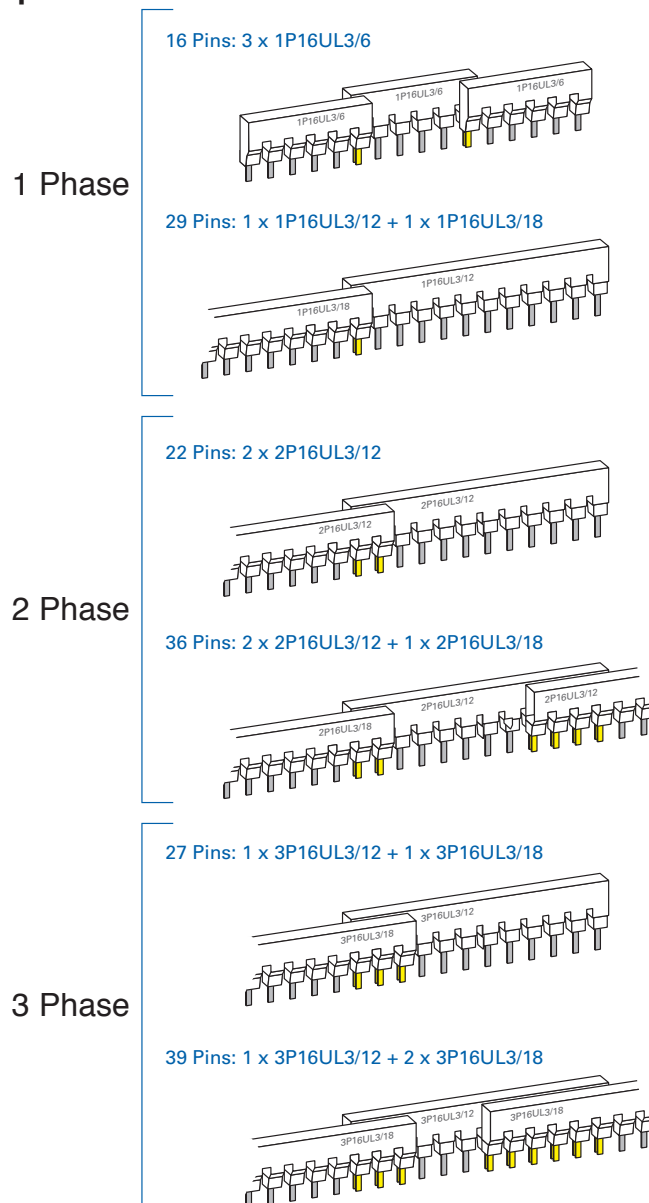

*For Questions, other configurations and detailed information please contact Altech Corp.

Busbar Selection Table

No. of Pins	Necessary Busbars	No. of Pins	Necessary Busbars	No. of Pins	Necessary Busbars	No. of Pins	Necessary Busbars
1 Phase System							
6	1x 1P16UL3/6	27	2x 1P16UL3/18 1x 1P16UL3/12 + 1x 1P16UL3/18	43	1x 1P16UL3/12 + 2x 1P16UL3/18 3x 1P16UL3/18	38	1x 2P16UL3/6 + 2x 2P16UL3/18 3x 2P16UL3/18
7	2x 1P16UL3/6		2x 1P16UL3/6 + 1x 1P16UL3/18	44	1x 1P16UL3/12 + 2x 1P16UL3/18 3x 1P16UL3/18		2x 2P16UL3/12 + 1x 2P16UL3/18 1x 2P16UL3/12 + 2x 2P16UL3/18
8	2x 1P16UL3/6		3x 1P16UL3/12	45	1x 1P16UL3/12 + 2x 1P16UL3/18 3x 1P16UL3/18	40	3x 2P16UL3/18 1x 2P16UL3/12 + 2x 2P16UL3/18
9	2x 1P16UL3/6	28	2x 1P16UL3/18 1x 1P16UL3/12 + 1x 1P16UL3/18	46	1x 1P16UL3/12 + 2x 1P16UL3/18 3x 1P16UL3/18	42	3x 2P16UL3/18 1x 2P16UL3/12 + 2x 2P16UL3/18
10	2x 1P16UL3/6		2x 1P16UL3/6 + 1x 1P16UL3/18	47	3x 1P16UL3/18	44	3x 2P16UL3/18 1x 2P16UL3/12 + 2x 2P16UL3/18
11	2x 1P16UL3/6		3x 1P16UL3/12	48	3x 1P16UL3/18	46	3x 2P16UL3/18
12	1x 1P16UL3/12 3x 1P16UL3/6	29	2x 1P16UL3/18 1x 1P16UL3/12 + 1x 1P16UL3/18	49	3x 1P16UL3/18	48	3x 2P16UL3/18
13	2x 1P16UL3/12 3x 1P16UL3/6 1x 1P16UL3/6 + 1x 1P16UL3/12	30	2x 1P16UL3/18 3x 1P16UL3/12 1x 1P16UL3/6 + 1x 1P16UL3/12 + 1x 1P16UL3/18	50	3x 1P16UL3/18	50	3x 2P16UL3/18
14	2x 1P16UL3/12 3x 1P16UL3/6 1x 1P16UL3/6 + 1x 1P16UL3/12		2x 1P16UL3/12 + 1x 1P16UL3/18	51	3x 1P16UL3/18		
15	2x 1P16UL3/12 3x 1P16UL3/6 1x 1P16UL3/6 + 1x 1P16UL3/12	31	2x 1P16UL3/18 3x 1P16UL3/12 1x 1P16UL3/6 + 1x 1P16UL3/12 + 1x 1P16UL3/18	52	3x 1P16UL3/18		
16	2x 1P16UL3/12 3x 1P16UL3/6 1x 1P16UL3/6 + 1x 1P16UL3/12		2x 1P16UL3/12 + 1x 1P16UL3/18	2 Phase System			
17	2x 1P16UL3/12 1x 1P16UL3/6 + 1x 1P16UL3/12	32	2x 1P16UL3/18 3x 1P16UL3/12 1x 1P16UL3/6 + 1x 1P16UL3/12 + 1x 1P16UL3/18	6	1x 2P16UL3/6	9	2x 3P16UL3/6
18	1x 1P16UL3/18 2x 1P16UL3/12 2x 1P16UL3/6 + 1x 1P16UL3/12 1x 1P16UL3/6 + 2x 1P16UL3/12		2x 1P16UL3/12 + 1x 1P16UL3/18	8	2x 2P16UL3/6	12	1x 3P16UL3/12
19	2x 1P16UL3/12 2x 1P16UL3/18 2x 1P16UL3/6 + 1x 1P16UL3/12 1x 1P16UL3/6 + 2x 1P16UL3/12	33	2x 1P16UL3/18 3x 1P16UL3/12 1x 1P16UL3/6 + 1x 1P16UL3/12 + 1x 1P16UL3/18	10	2x 2P16UL3/6	15	1x 3P16UL3/6 + 1x 3P16UL3/12
20	2x 1P16UL3/12 2x 1P16UL3/18 1x 1P16UL3/6 + 2x 1P16UL3/12 2x 1P16UL3/6 + 1x 1P16UL3/12 1x 1P16UL3/6 + 1x 1P16UL3/18 1x 1P16UL3/12 + 1x 1P16UL3/18		2x 1P16UL3/12 + 2x 1P16UL3/18	12	3x 2P16UL3/6 1x 2P16UL3/12	18	1x 3P16UL3/18 1x 3P16UL3/12 + 2x 3P16UL3/6 2x 3P16UL3/12
21	2x 1P16UL3/12 2x 1P16UL3/18 2x 1P16UL3/6 + 1x 1P16UL3/12 1x 1P16UL3/6 + 2x 1P16UL3/12 1x 1P16UL3/6 + 1x 1P16UL3/18 1x 1P16UL3/12 + 1x 1P16UL3/18	34	2x 1P16UL3/18 3x 1P16UL3/12 1x 1P16UL3/6 + 1x 1P16UL3/12 + 1x 1P16UL3/18	14	3x 2P16UL3/6 2x 2P16UL3/12 1x 2P16UL3/6 + 1x 2P16UL3/12	21	2x 3P16UL3/12 1x 3P16UL3/6 + 1x 3P16UL3/18 1x 3P16UL3/12 + 1x 3P16UL3/18 2x 3P16UL3/18
22	2x 1P16UL3/12 2x 1P16UL3/18 2x 1P16UL3/6 + 1x 1P16UL3/12 1x 1P16UL3/6 + 2x 1P16UL3/12 1x 1P16UL3/6 + 1x 1P16UL3/18 1x 1P16UL3/12 + 1x 1P16UL3/18		2x 1P16UL3/12 + 1x 1P16UL3/18	16	2x 2P16UL3/12 1x 2P16UL3/6 + 1x 2P16UL3/12	24	1x 3P16UL3/12 + 1x 3P16UL3/18 2x 3P16UL3/6 + 1x 3P16UL3/18 1x 3P16UL3/6 + 2x 3P16UL3/12 3x 3P16UL3/18 2x 3P16UL3/18
23	2x 1P16UL3/12 2x 1P16UL3/18 1x 1P16UL3/6 + 1x 1P16UL3/18 1x 1P16UL3/12 + 1x 1P16UL3/18	35	2x 1P16UL3/18 2x 1P16UL3/12 + 1x 1P16UL3/18 1x 1P16UL3/12 + 2x 1P16UL3/18	18	1x 2P16UL3/18 2x 2P16UL3/12 2x 2P16UL3/6 + 1x 2P16UL3/12 2x 2P16UL3/18 1x 2P16UL3/12 + 1x 2P16UL3/18	27	1x 3P16UL3/12 + 1x 3P16UL3/18 2x 3P16UL3/18 3x 3P16UL3/12
24	2x 1P16UL3/12 2x 1P16UL3/18 1x 1P16UL3/12 + 1x 1P16UL3/18		2x 1P16UL3/12 + 2x 1P16UL3/18	20	2x 2P16UL3/6 + 1x 2P16UL3/12 1x 2P16UL3/6 + 1x 2P16UL3/18 2x 2P16UL3/12 2x 2P16UL3/18 1x 2P16UL3/12 + 1x 2P16UL3/18	30	2x 3P16UL3/18 2x 3P16UL3/12 + 1x 3P16UL3/18 3x 3P16UL3/12 1x 3P16UL3/6 + 1x 3P16UL3/12 + 1x 3P16UL3/18
25	2x 1P16UL3/12 2x 1P16UL3/18 1x 1P16UL3/12 + 1x 1P16UL3/18	36	1x 1P16UL3/18 2x 1P16UL3/12 + 1x 1P16UL3/18 3x 1P16UL3/18 1x 1P16UL3/12 + 2x 1P16UL3/18	22	2x 2P16UL3/12 2x 2P16UL3/18 1x 2P16UL3/6 + 1x 2P16UL3/18 1x 2P16UL3/12 + 1x 2P16UL3/18	33	2x 3P16UL3/18 2x 3P16UL3/12 + 1x 3P16UL3/18
26	2x 1P16UL3/18 1x 1P16UL3/12 + 1x 1P16UL3/18 2x 1P16UL3/6 + 1x 1P16UL3/18 3x 1P16UL3/12		2x 1P16UL3/12 + 2x 1P16UL3/18	24	2x 2P16UL3/6 + 1x 2P16UL3/18 1x 2P16UL3/6 + 2x 2P16UL3/12 3x 2P16UL3/12 2x 2P16UL3/18 1x 2P16UL3/12 + 1x 2P16UL3/18	36	1x 3P16UL3/6 + 2x 3P16UL3/18 2x 3P16UL3/12 + 1x 3P16UL3/18 1x 3P16UL3/12 + 2x 3P16UL3/18 3x 3P16UL3/18
		37	1x 1P16UL3/6 + 2x 1P16UL3/18 2x 1P16UL3/12 + 1x 1P16UL3/18 3x 1P16UL3/18 1x 1P16UL3/12 + 2x 1P16UL3/18	26	2x 2P16UL3/6 + 1x 2P16UL3/18 1x 2P16UL3/6 + 2x 2P16UL3/12 3x 2P16UL3/12 2x 2P16UL3/18 1x 2P16UL3/12 + 1x 2P16UL3/18	39	1x 3P16UL3/12 + 2x 3P16UL3/18 3x 3P16UL3/18
		38	1x 1P16UL3/6 + 2x 1P16UL3/18 2x 1P16UL3/12 + 1x 1P16UL3/18 3x 1P16UL3/18 1x 1P16UL3/12 + 2x 1P16UL3/18	28	3x 2P16UL3/12 2x 2P16UL3/18 1x 2P16UL3/12 + 1x 2P16UL3/18	42	1x 3P16UL3/12 + 2x 3P16UL3/18 3x 3P16UL3/18
		39	1x 1P16UL3/6 + 2x 1P16UL3/18 2x 1P16UL3/12 + 1x 1P16UL3/18 3x 1P16UL3/18 1x 1P16UL3/12 + 2x 1P16UL3/18	30	1x 2P16UL3/6 + 1x 2P16UL3/12 + 1x 2P16UL3/18 3x 2P16UL3/12 2x 2P16UL3/12 + 1x 2P16UL3/18 2x 2P16UL3/18	45	3x 3P16UL3/18
		40	1x 1P16UL3/6 + 2x 1P16UL3/18 2x 1P16UL3/12 + 1x 1P16UL3/18 1x 1P16UL3/12 + 2x 1P16UL3/18 3x 1P16UL3/18	32	1x 2P16UL3/6 + 1x 2P16UL3/12 + 1x 2P16UL3/18 3x 2P16UL3/12 2x 2P16UL3/12 + 1x 2P16UL3/18 2x 2P16UL3/18	48	3x 3P16UL3/18
		41	1x 1P16UL3/12 + 2x 1P16UL3/18 3x 1P16UL3/18	34	1x 2P16UL3/6 + 1x 2P16UL3/12 + 1x 2P16UL3/18 2x 2P16UL3/12 + 1x 2P16UL3/18 2x 2P16UL3/18		
		42	1x 1P16UL3/12 + 2x 1P16UL3/18 3x 1P16UL3/18	36	1x 2P16UL3/6 + 2x 2P16UL3/18 3x 2P16UL3/18 2x 2P16UL3/12 + 1x 2P16UL3/18 1x 2P16UL3/12 + 2x 2P16UL3/18		

Note: For detailed information and examples see page 20.