



SERVO DRIVE

FlexDrive^{II} / Flex+Drive^{II}

Servo Controls

Installation Manual

Contents

1	General Information	1-1
2	Introduction	2-1
2.1	FlexDrive ^{II} features	2-1
2.2	Receiving and inspection	2-2
2.2.1	Identifying the catalog number	2-2
2.3	Units and abbreviations	2-3
3	Basic Installation	3-1
3.1	Introduction	3-1
3.1.1	Power sources	3-1
3.1.2	Hardware requirements	3-1
3.1.3	RS485 / RS422 systems	3-2
3.1.4	Tools and miscellaneous hardware	3-2
3.1.5	Other information needed for installation	3-3
3.2	Mechanical installation and location requirements	3-4
3.2.1	Mounting the FlexDrive ^{II}	3-5
3.2.2	Dimensions	3-6
3.3	Connector locations	3-7
3.4	Power connections	3-8
3.4.1	Single-phase connection to package sizes A, B, C, D	3-9
3.4.2	Three-phase connection to package sizes E, G, H	3-10
3.4.3	Input power conditioning	3-11
3.4.4	Power disconnect and protection devices	3-11
3.4.5	Power supply filters	3-12
3.4.6	Wire sizes and protection device ratings	3-13
3.4.7	External customer supplied 24V control supply	3-14
3.5	Motor connections	3-15
3.5.1	Motor circuit contactors	3-16
3.5.2	Motor power cable pin configuration - Baldor BSM rotary motors	3-16
3.5.3	Motor cable pin configuration - Baldor linear motors	3-17
3.5.4	Sinusoidal filter	3-17
3.5.5	Thermal switch connection	3-18
3.5.6	Motor brake connection	3-19
3.6	Regeneration resistor (Dynamic Brake resistor)	3-20
3.6.1	Controlling regeneration	3-20
3.7	Feedback connections	3-21
3.7.1	Resolver option - X8	3-22
3.7.2	Encoder option - X8	3-24
3.7.3	EnDat (absolute encoder) option - X8	3-27
3.7.4	Hiperface (absolute encoder) option - X8	3-29

3.8	Drive enable - X3	3-31
3.8.1	Drive enable - X3	3-31
3.8.2	Drive enable - SW1 DIP switch	3-32
3.8.3	Drive enable command	3-32
3.9	DIP switches - SW1	3-33
3.9.1	Switches 1-4	3-33
3.9.2	Switch 5 - Hold	3-34
3.9.3	Switch 6 - RS485 terminator	3-34
3.9.4	Switch 7 - Offset tuning	3-34
3.9.5	Switch 8 - Enable	3-34
3.9.6	Switch 9 - MODBUS select	3-35
3.9.7	Switch 10 - RS232/RS485 select	3-35
3.9.8	Factory settings	3-35
3.9.9	Preventing a program running at startup	3-36
4	Input / Output	4-1
4.1	Introduction	4-1
4.2	Analog I/O	4-1
4.2.1	Analog input - X3 (demand)	4-2
4.3	Digital I/O	4-4
4.3.1	Digital inputs - X3	4-5
4.3.2	CREF and digital inputs	4-6
4.3.3	Special functions on DIN4 and DIN5 - pulse and direction inputs	4-6
4.3.4	Special functions on DIN4 and DIN5 - fast inputs	4-8
4.3.5	Digital outputs - X3	4-9
4.3.6	Relay output / digital output - X3	4-10
4.4	Other I/O	4-11
4.4.1	Encoder output - X7	4-11
4.4.2	Master (auxiliary) encoder input - X9	4-13
4.4.3	Serial port - X6	4-15
4.4.4	Using RS232 cable	4-16
4.4.5	Multidrop using RS485 / RS422 cable	4-17
4.4.6	Connecting Baldor HMI Operator Panels	4-18
4.5	Connection summary - minimum system wiring	4-19
4.6	Option connectors	4-20
5	Operation	5-1
5.1	Introduction	5-1
5.1.1	Connecting the FlexDrive ^{II} to the PC	5-1
5.1.2	Installing the software	5-1
5.1.3	Starting the FlexDrive ^{II}	5-2
5.1.4	Preliminary checks	5-2
5.1.5	Power on checks	5-2
5.1.6	Offset tuning	5-3

5.2	Mint WorkBench	5-4
5.2.1	Help file	5-4
5.2.2	Starting Mint WorkBench	5-5
5.2.3	Commissioning Wizard	5-7
5.2.4	Using the Commissioning Wizard	5-7
5.2.5	Completing the Commissioning Wizard	5-7
5.2.6	Performing a test move	5-8
5.3	Further configuration	5-9
5.3.1	Fine-tuning tool	5-9
5.3.2	Parameters tool	5-11
5.3.3	Digital I/O tool	5-12
5.3.4	Other tools and windows	5-12
6	Preset Moves & PLC Task	6-1
6.1	Introduction	6-1
6.2	Preset moves	6-2
6.2.1	Defining a preset move	6-2
6.2.2	Testing a preset move	6-3
6.2.3	Using digital inputs to trigger a preset move	6-3
6.2.4	Controlling preset moves	6-6
6.2.5	Using presets with the CAN & Auxiliary I/O option	6-6
6.3	PLC Task	6-7
6.3.1	Defining conditions	6-7
6.3.2	Enabling and downloading the actions	6-8
6.3.3	Testing the PLC Task	6-9
6.4	Saving presets or PLC conditions	6-9
7	Troubleshooting	7-1
7.1	Introduction	7-1
7.1.1	Problem diagnosis	7-1
7.1.2	SupportMe feature	7-1
7.1.3	Power-cycling the FlexDrive ^{II}	7-1
7.2	FlexDrive ^{II} indicators	7-2
7.2.1	Status display	7-2
7.2.2	DB On (Regeneration) LED	7-5
7.2.3	Communication	7-5
7.2.4	Power on	7-6
7.2.5	Tuning	7-6
7.2.6	Status display shows a digit or 'E.'	7-6
8	Specifications	8-1
8.1	Introduction	8-1
8.1.1	AC input power and motor output - single-phase models	8-2
8.1.2	AC input power and motor output - 230V three-phase models	8-3
8.1.3	AC input power and motor output - 230-460V three-phase models	8-4

8.1.4	Customer supplied 24VDC supply input	8-5
8.1.5	Regeneration	8-5
8.1.6	Analog input (X3)	8-6
8.1.7	Digital inputs (X3)	8-7
8.1.8	Digital outputs (X3)	8-7
8.1.9	Relay / general purpose output (X3)	8-8
8.1.10	Serial RS232 interface (X6)	8-8
8.1.11	Serial RS485 interface (X6)	8-8
8.1.12	Encoder output (simulated) (X7)	8-9
8.1.13	Resolver feedback option (X8)	8-9
8.1.14	Encoder feedback option (X8)	8-9
8.1.15	EnDat (absolute encoder) feedback option (X8)	8-10
8.1.16	Hiperface (absolute encoder) feedback option (X8)	8-10
8.1.17	Master (auxiliary) encoder input (X9)	8-10
8.1.18	Pulse and direction input (X9)	8-11
8.1.19	Environmental	8-11

Appendices

A	Accessories	A-1
A.1	Introduction	A-1
A.1.1	Factory fitted options	A-1
A.1.2	Motor power cables	A-2
A.1.3	Motor power cable part numbers	A-2
A.1.4	Resolver feedback cables	A-3
A.1.5	Encoder / Hall feedback cables	A-4
A.1.6	EnDat / Hiperface (absolute encoder) feedback cables	A-4
A.1.7	Feedback cable part numbers	A-5
A.1.8	EMC filters	A-6
A.1.9	Regeneration resistors	A-9
B	Control System	B-1
B.1	Introduction	B-1
B.1.1	Current (Torque) control	B-2
B.1.2	Velocity (Speed) control	B-3
B.1.3	Position control (Pulse and Direction)	B-4
B.1.4	Position control	B-5
B.2	Control system operation	B-6
B.2.1	Position controller	B-6
B.2.2	Speed controller	B-7
B.2.3	Torque controller and feedback	B-8
C	Mint Keyword Summary	C-1
C.1	Introduction	C-1
C.1.1	Keyword listing	C-1

D	CE & UL	D-1
D.1	Introduction	D-1
D.1.1	EMC Conformity and CE marking	D-1
D.1.2	Declaration of conformity	D-2
D.1.3	Use of CE compliant components	D-3
D.1.4	EMC wiring technique	D-3
D.1.5	EMC installation suggestions	D-4
D.1.6	Wiring of shielded (screened) cables	D-5
D.2	UL file numbers	D-6

LT0160A05 Copyright Baldor (c) 2010 All rights reserved.

This manual is copyrighted and all rights are reserved. This document or attached software may not, in whole or in part, be copied or reproduced in any form without the prior written consent of Baldor. Baldor makes no representations or warranties with respect to the contents hereof and specifically disclaims any implied warranties of fitness for any particular purpose. The information in this document is subject to change without notice. Baldor assumes no responsibility for any errors that may appear in this document.

Mint™ is a registered trademark of Baldor.

Windows 2000, Windows XP and Windows 2000 are registered trademarks of the Microsoft Corporation.

UL and cUL are registered trademarks of Underwriters Laboratories.

EnDat is a registered trademark of Heidenhain Corporation.

Hiperface is a registered trademark of Max Stegmann GmbH.

Limited Warranty

For a period of two (2) years from the date of original purchase, Baldor will repair or replace without charge controls and accessories that our examination proves to be defective in material or workmanship. This warranty is valid if the unit has not been tampered with by unauthorized persons, misused, abused, or improperly installed and has been used in accordance with the instructions and/or ratings supplied. This warranty is in lieu of any other warranty or guarantee expressed or implied. Baldor shall not be held responsible for any expense (including installation and removal), inconvenience, or consequential damage, including injury to any person or property caused by items of our manufacture or sale. (Some countries and U.S. states do not allow exclusion or limitation of incidental or consequential damages, so the above exclusion may not apply.) In any event, Baldor's total liability, under all circumstances, shall not exceed the full purchase price of the control. Claims for purchase price refunds, repairs, or replacements must be referred to Baldor with all pertinent data as to the defect, the date purchased, the task performed by the control, and the problem encountered. No liability is assumed for expendable items such as fuses. Goods may be returned only with written notification including a Baldor Return Authorization Number and any return shipments must be prepaid.

Baldor UK Ltd
Mint Motion Centre
6 Bristol Distribution Park
Hawley Drive
Bristol, BS32 0BF
Telephone: +44 (0) 1454 850000
Fax: +44 (0) 1454 850001
E-mail: motionsupport.uk@baldor.com
Web site: www.baldormotion.com

See rear cover for other international offices.

Product notice

Only qualified personnel should attempt the start-up procedure or troubleshoot this equipment. This equipment may be connected to other machines that have rotating parts or parts that are controlled by this equipment. Improper use can cause serious or fatal injury. Only qualified personnel should attempt to start-up, program or troubleshoot this equipment.

Safety Notice

Intended use: These drives are intended for use in stationary ground based applications in industrial power installations according to the standards EN60204 and VDE0160. They are designed for machine applications that require variable speed controlled three-phase brushless AC motors. These drives are not intended for use in applications such as:

- Home appliances
- Medical instrumentation
- Mobile vehicles
- Ships
- Airplanes.

Unless otherwise specified, this drive is intended for installation in a suitable enclosure. The enclosure must protect the drive from exposure to excessive or corrosive moisture, dust and dirt or abnormal ambient temperatures. The exact operating specifications are found in section 8 of this manual. The installation, connection and control of drives is a skilled operation, disassembly or repair must not be attempted. In the event that a drive fails to operate correctly, contact the place of purchase for return instructions.

Precautions



WARNING: Do not touch any circuit board, power device or electrical connection before you first ensure that no high voltage is present at this equipment or other equipment to which it is connected. Electrical shock can cause serious or fatal injury. Only qualified personnel should attempt to start-up, program or troubleshoot this equipment.



WARNING: Be sure the system is properly earthed/grounded before applying power. Do not apply AC power before you ensure that earths/grounds are connected. Electrical shock can cause serious or fatal injury.



WARNING: Be sure that you are completely familiar with the safe operation and programming of this equipment. This equipment may be connected to other machines that have rotating parts or parts that are controlled by this equipment. Improper use can cause serious or fatal injury. Only qualified personnel should attempt to program, start-up or troubleshoot this equipment.



WARNING: MEDICAL DEVICE / PACEMAKER DANGER: Magnetic and electromagnetic fields in the vicinity of current carrying conductors and industrial motors can result in a serious health hazard to persons with cardiac pacemakers, internal cardiac defibrillators, neurostimulators, metal implants, cochlear implants, hearing aids, and other medical devices. To avoid risk, stay away from the area surrounding a motor and its current carrying conductors.



WARNING: Be sure all wiring complies with the National Electrical Code and all regional and local codes. Improper wiring may result in unsafe conditions.



WARNING: The stop input to this equipment should not be used as the single means of achieving a safety critical stop. Drive disable, motor disconnect, motor brake and other means should be used as appropriate. Only qualified personnel should attempt to program, start-up or troubleshoot this equipment.



WARNING: Improper operation or programming of the drive may cause violent motion of the motor and driven equipment. Be certain that unexpected motor movement will not cause injury to personnel or damage to equipment. Peak torque of several times the rated motor torque can occur during control failure.



WARNING: The motor circuit might have high voltages present whenever AC power is applied, even when the motor is not moving. Electrical shock can cause serious or fatal injury.



WARNING: If a motor is driven mechanically, it might generate hazardous voltages that are conducted to its power terminals. The enclosure must be earthed/grounded to prevent possible shock hazard.



WARNING: When operating a rotary motor with no load coupled to its shaft, remove the shaft key to prevent it flying out when the shaft rotates.



WARNING: A regeneration resistor may generate enough heat to ignite combustible materials. To avoid fire hazard, keep all combustible materials and flammable vapors away from the brake resistors.



CAUTION: To prevent equipment damage, be certain that the input power has correctly sized protective devices installed.



CAUTION: To prevent equipment damage, be certain that input and output signals are powered and referenced correctly.



CAUTION: To ensure reliable performance of this equipment be certain that all signals to/from the drive are shielded correctly.



CAUTION: Suitable for use on a circuit capable of delivering not more than the RMS symmetrical short circuit amperes listed here at rated voltage.

Horsepower

1-50

RMS Symmetrical Amperes

5,000



CAUTION: Avoid locating the drive immediately above or beside heat generating equipment, or directly below water or steam pipes.



CAUTION: Avoid locating the drive in the vicinity of corrosive substances or vapors, metal particles and dust.



CAUTION: Do not connect AC power to the drive terminals U, V and W. Connecting AC power to these terminals may result in damage to the drive.



CAUTION: Baldor does not recommend using "Grounded Leg Delta" transformer power leads that may create earth/ground loops and degrade system performance. Instead, we recommend using a four wire Wye.



CAUTION: Drives are intended to be connected to a permanent main power source, not a portable power source. Suitable fusing and circuit protection devices are required.



CAUTION: The safe integration of the drive into a machine system is the responsibility of the machine designer. Be sure to comply with the local safety requirements at the place where the machine is to be used. In Europe these are the Machinery Directive, the ElectroMagnetic Compatibility Directive and the Low Voltage Directive. In the United States this is the National Electrical code and local codes.



CAUTION: Drives must be installed inside an electrical cabinet that provides environmental control and protection. Installation information for the drive is provided in this manual. Motors and controlling devices that connect to the drive should have specifications compatible to the drive.



CAUTION: If the drive is subjected to high potential ('hipot') testing, only DC voltages may be applied. AC voltage hipot tests could damage the drive. For further information please contact your local Baldor representative.



CAUTION: Violent jamming (stopping) of the motor during operation may damage the motor and drive.



CAUTION: Do not tin (solder) exposed wires. Solder contracts over time and may cause loose connections. Use crimp connections where possible.



CAUTION: Electrical components can be damaged by static electricity. Use ESD (electro-static discharge) procedures when handling this drive.



CAUTION: Ensure that resolver or encoder wires are properly connected. Incorrect installation may result in improper movement.



CAUTION: The threaded holes in the top and bottom of the enclosure are for cable clamps. Be sure to use a M4 bolt no longer than 12mm in length. Longer bolts might short-circuit the electrical components inside the drive.



CAUTION: Removing the cover will invalidate UL certification.

2.1 FlexDrive^{II} features

Throughout this manual, both the FlexDrive^{II} and the Flex+Drive^{II} will be referred to simply as FlexDrive^{II}. Where there is a difference in specification it will be clearly marked.

The FlexDrive^{II} is a versatile compact control, providing a flexible and powerful solution for single axis rotary systems. Standard features include:

- Single axis AC brushless drive
- Wide range of models with continuous current ratings from 2.5A to 27.5A
- Direct connection to 115VAC or 230VAC single-phase or 230-460VAC three-phase supplies (model dependent)
- Resolver, encoder, EnDat or Hiperface feedback
- Velocity and current control, with pulse and direction input for position control
- Auto-tuning wizard (including position loop) and software oscilloscope facilities
- 8 optically isolated digital inputs
- 3 optically isolated digital outputs
- 1 general-purpose analog input (can be used as a speed or torque demand reference)
- 1 control relay
- Selectable RS232 or RS485 communications

Flex+Drive^{II} only:

- Integrated motion controller for rotary and linear positioning systems
- Programmable in Mint
- Up to 16 programmable preset moves (expandable to 256 with factory-fitted CAN and I/O option)
- Position control using preset moves, software gearing and point to point moves
- Flash memory for program storage (64k).
- Motion controller for rotary and linear positioning systems

Factory-fitted options expand the I/O capabilities of the FlexDrive^{II} and provide CANopen, DeviceNet or Profibus connectivity. See Appendix A for details about options. FlexDrive^{II} will operate with a large number of brushless servo motors - for information on selecting Baldor servo motors, please see the sales brochure BR1202 (BR1800 for linear motors) available from your local Baldor representative.

This manual is intended to guide you through the installation of FlexDrive^{II}. The sections should be read in sequence.

The *Basic Installation* section describes the mechanical installation of the FlexDrive^{II}, the power supply connections and motor connections. The other sections require knowledge of the low level input/output requirements of the installation and an understanding of computer software installation. If you are not qualified in these areas you should seek assistance before proceeding.

2.2 Receiving and inspection

When you receive your FlexDrive^{II}, there are several things you should do immediately:

1. Check the condition of the shipping container and report any damage immediately to the carrier that delivered your FlexDrive^{II}.
2. Remove the FlexDrive^{II} from the shipping container and remove all packing material. The container and packing materials may be retained for future shipment.
3. Verify that the catalog number of the FlexDrive^{II} you received is the same as the catalog number listed on your purchase order. The catalog number is described in the next section.
4. Inspect the FlexDrive^{II} for external damage during shipment and report any damage to the carrier that delivered your FlexDrive^{II}.
5. If FlexDrive^{II} is to be stored for several weeks before use, be sure that it is stored in a location that conforms to the storage humidity and temperature specifications shown in section 8.1.19.

2.2.1 Identifying the catalog number

The FlexDrive^{II} is available with different current ratings and package sizes. The catalog number is marked on the front of the unit, just below the Baldor logo. It is a good idea to look for the catalog number (sometimes shown as ID/No:) and write it in the space provided here:

Catalog number: **F_H** _____ - _____

Installed at: _____

Date: _____

A description of a catalog number is shown here, using the example **FDH1A05TB-RC23**:

	Meaning	Alternatives
FDH	FlexDrive ^{II} family	FPH =Flex+Drive ^{II}
1	Requires an AC supply voltage of 115 Volts, 1Φ	2 =230V (1Φ or 3Φ); 4 =230V-460V (3Φ)
A05	Continuous current rating of 5.0A	A02 =2.5A; A07 =7.5A; A15 =15A; A20 =20A; A27 =27.5A
T	Built in AC power supply	-
B	Dynamic Brake with a built in transistor and resistor (available on 2.5A and 5A models only)	R =Requires external braking resistor
R	Feedback option is a resolver	E =Encoder (incremental); D =EnDat (absolute encoder); H =Hiperface (absolute encoder)
C	Option fitted: 1 CAN channel	B =CAN & Auxiliary I/O (Flex+Drive ^{II} only); D =DeviceNet; P =Profibus DP; N =No options specified
2	Serial port type is combined RS232 / RS485	-
3	Customer's own 24VDC supply is required to power the internal FlexDrive ^{II} logic	0 = Internally generated 24VDC supply*

Additional suffix letters may be used to indicate customer-specific builds.

* An external 24VDC supply will always be required to operate the enable input, digital inputs and digital outputs on connector X3. See sections 4.3.1 to 4.3.5.

2.3 Units and abbreviations

The following units and abbreviations are used in this manual:

V Volt (also VAC and VDC)
 W Watt
 A Ampere
 Ω Ohm
 μ F microfarad
 pF picofarad
 mH millihenry

Φ phase
 ms millisecond
 μ s microsecond
 ns nanosecond

Kbaud kilobaud (the same as Kbit/s in most applications)
 MB megabytes
 CDROM Compact Disc Read Only Memory
 CTRL+E on the PC keyboard, press **Ctrl** then **E** at the same time.

mm millimeter
 m meter
 in inch
 ft feet
 lb-in pound-inch (torque)
 Nm Newton-meter (torque)

ADC Analog to Digital Converter
 DAC Digital to Analog Converter
 AWG American Wire Gauge
 (NC) Not Connected

3.1 Introduction

You should read all the sections in *Basic Installation* to ensure safe installation.

This section describes the mechanical and electrical installation of the FlexDrive^{II} in the following stages:

- Location considerations
- Mounting the FlexDrive^{II}
- Connecting the AC power supply
- Connecting the optional customer supplied 24VDC control supply
- Connecting the motor
- Installing a regeneration resistor (Dynamic Brake resistor)
- Connecting the feedback device
- Connecting the drive enable input.

These stages should be read and followed in sequence.

3.1.1 Power sources

An AC power source (IEC1010 over-voltage category III or less) in the installation area is required. This will need to be single or three-phase depending upon the type of FlexDrive^{II}. An AC power filter is required to comply with the CE directive for which the FlexDrive^{II} was tested (see section 3.4.5).

If the FlexDrive^{II} requires an external (customer supplied) 24VDC logic supply then this must be a regulated power supply with a continuous current supply capability of 1.75A (4A power on surge). A 24V filter may be required to comply with the CE directive for which the FlexDrive^{II} was tested (see section 3.4.5).

3.1.2 Hardware requirements

The components you will need to complete the basic installation are:

- The motor that will be connected to the FlexDrive^{II}
- A motor power cable
- A resolver or encoder feedback cable (and Hall cable for linear motors)
- With some applications there may be a requirement for a regeneration resistor (Dynamic Brake).

Note: Without the regeneration resistor, the drive may produce an overvoltage fault. All FlexDrive^{II} models have overvoltage sensing circuitry, but only 2.5A and 5A models (catalog numbers FDHxxxxxB-xxxx and FPHxxxxxB-xxxx) have an internal regeneration resistor. For 7.5A, 15A, 20A and 27.5A models a regeneration resistor must be purchased separately if required. See Appendix A.

- A serial cable.

Note: The serial connector on the FlexDrive^{II} (connector X6) can be configured as either RS232 or RS485 / RS422. Pin 9 is used to carry +8V for powering some Baldor keypad peripherals. Ensure that pin 9 is not connected to earth/ground or to equipment that could be damaged by the +8V supply. See sections 4.4.3 and 4.4.4. A suitable cable is available from Baldor, catalog number CBL001-501.

- A PC (with one free COM port) with the following specification:

	Minimum specification	Recommended specification
Processor	Intel PentiumIII 500 MHz or faster	Intel PentiumIII / 4 or equivalent 1 GHz or faster
RAM	128 MB	1 GB
Hard disk space	50 MB	50 MB
CD-ROM	A CD-ROM drive	
Screen	1024 x 768, 16-bit color	1152 x 864, 16-bit color
Mouse	A mouse or similar pointing device	
Operating system	Windows 2000, Windows XP or Windows Vista	

3.1.3 RS485 / RS422 systems

If you will be using RS485 / RS422 and your PC does not have an RS485 / RS422 connector, an RS232 to 4-wire RS485 / RS422 converter will be required. These commercially available devices convert the signals from the RS232/RS485 port (connector X6) to the signals necessary for RS485 / RS422 communications. Special care must be taken with the pin assignment on all RS485 / RS422 devices, as this can differ between products. Connectors might need to be rewired to provide the correct pin assignment. The FlexDrive^{II} pin assignment is shown in section 4.4.3.

Note: If this is the first time you are installing a FlexDrive^{II} then it is strongly recommended that you use RS232 to get started and try RS485 later. This will avoid any potential problems involving the RS232-RS485 converter. Selection of RS232 or RS485 is controlled using DIP switch 10 - see section 3.9.7.

3.1.4 Tools and miscellaneous hardware

- Your PC operating system user manual might be useful if you are not familiar with Windows
- A small screwdriver (supplied) with a blade width less than 3mm (1/10 in)
- M5 screws or bolts for mounting the FlexDrive^{II}
- Crimping tool.

A connector kit is supplied with your FlexDrive^{II}. This contains a number of useful connectors and a screwdriver for tightening the connections.

3.1.5 Other information needed for installation

This information is useful (but not essential) to complete the installation:

- The data sheet or manual provided with your motor, describing the wiring information of the motor cables/connectors
- Knowledge of which digital inputs/outputs will be 'Active Low', 'Active High' or edge triggered.

3.2 Mechanical installation and location requirements

It is essential that you read and understand this section before beginning the installation.



CAUTION: To prevent equipment damage, be certain that the input power has correctly rated protective devices installed.



CAUTION: To prevent equipment damage, be certain that input and output signals are powered and referenced correctly.



CAUTION: To ensure reliable performance of this equipment be certain that all signals to/from the FlexDrive^{II} are shielded correctly.



CAUTION: Avoid locating the FlexDrive^{II} immediately above or beside heat generating equipment, or directly below water steam pipes.



CAUTION: Avoid locating the FlexDrive^{II} in the vicinity of corrosive substances or vapors, metal particles and dust.

The safe operation of this equipment depends upon its use in the appropriate environment. The following points must be considered:

- The FlexDrive^{II} must be installed indoors, permanently fixed and located so that it can only be accessed by service personnel using tools.
- The maximum suggested operating altitude is 1000m (3300ft). Above 1000m (3300ft) de-rate output current 1.1% per 100m (330ft).
- The FlexDrive^{II} must operate in an ambient temperature of 0°C to 40°C (32°F to 104°F). De-rate output current 2.5% per 1°C (1.8°F) from 40°C (104°F) to 50°C (122°F) maximum.
- The FlexDrive^{II} must operate in relative humidity levels of less than 90% for temperatures up to 31°C (87°F) decreasing linearly to 50% relative humidity at 40°C (104°F) (non-condensing).
- The FlexDrive^{II} must be installed where the pollution degree according to IEC664 shall not exceed 2.
- The external customer supplied 24VDC for the logic supply must be installed so that the 24VDC supplied to the unit is isolated from the AC supply using double or reinforced insulation.
- The inputs and outputs of the control circuit must be limited to Safety Extra Low Voltage circuits.
- Both the AC supply and the external 24VDC supply must be fused.
- The atmosphere must not contain flammable gases or vapors.
- There must not be abnormal levels of nuclear radiation or X-rays.
- The FlexDrive^{II} must be secured by the slots in the flange, with the protective earth/ground stud bonded to a safety earth/ground by either a 25A conductor or a conductor of three times the peak current rating - whichever is the greater.

- For effective cooling and maintenance, the FlexDrive^{II} should be mounted on a smooth, non-flammable vertical surface. The power handling capability is affected by the temperature of the left side of the unit.
- At least 50mm (2 in) top and bottom clearance of the FlexDrive^{II} must be provided for airflow.
- If multiple FlexDrive^{II} are being mounted side by side there must be 13mm (0.5 in) between them. The FlexDrive^{II} nearest the side of the cabinet / enclosure must be separated from it by at least 13mm (0.5 in).
- To comply with CE directive 89/336/EEC an appropriate AC filter must be installed. The external customer supplied 24VDC logic supply might also require a 24V filter. See section 3.4.7.
- The threaded holes in the top and bottom of the enclosure are for cable clamps. The holes are threaded for M4 bolts no longer than 12mm (0.47 in) in length. Longer bolts may short circuit the electrical components inside the FlexDrive^{II}.
- Each D-type connector on the front panel of the FlexDrive^{II} is secured using two hexagonal jack screws (sometimes known as “screwlocks”). If a jack screw is removed accidentally or lost it must be replaced with an identical jack screw with an external male threaded section of 5mm (0.2 in). Jack screws with longer threads could damage or short circuit internal components.

3.2.1 Mounting the FlexDrive^{II}

Ensure you have read and understood the *Mechanical installation and location requirements* in section 3.2. Mount your FlexDrive^{II} on its rear side, the side opposite to the front panel. The FlexDrive^{II} must be mounted upright to ensure adequate cooling (you can check this by ensuring that the Hazardous Voltages warning information is clearly readable to you). M5 bolts or screws should be used to mount the FlexDrive^{II}.

There are seven different package sizes depending on the specification of the FlexDrive^{II} :

AC power	Current	Factory fitted option	Package size
Single-phase	2A	without option	A
		with option	B
	5A	without option	C
		with option	D
	7.5A	without option	D
		with option	D
230V Three-phase	15A	with or without option	E
230-460V Three-phase	2.5A, 5A, 7.5A	with or without option	G
	15A, 20A, 27.5A	with or without option	H

Detailed dimensions for each package are shown in section 3.2.2.

3.2.2 Dimensions

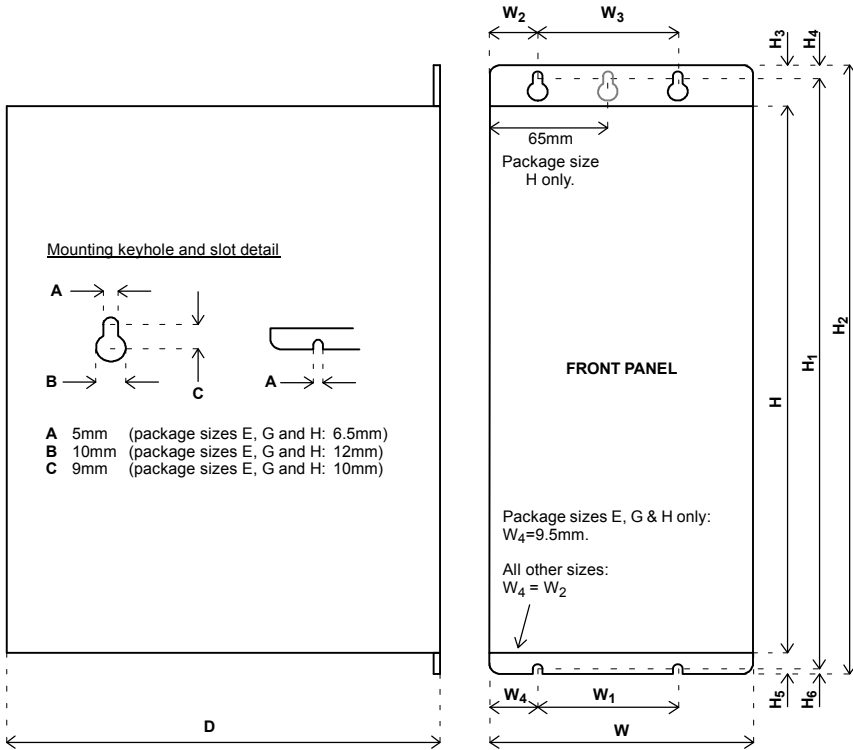

Pack	Dimensions mm / inches												Weight kg / lb
	W	W ₁	W ₂	W ₃	H	H ₁	H ₂	H ₃	H ₄	H ₅	H ₆	D	
A	67.5 2.66	40 1.57	15 0.59	40 1.57	173 6.81	195.5 7.70	205 8.07	23.5 0.93	6.5 0.26	8.5 0.33	3 0.12	152 6.00	1.25 2.76
B	84 3.31												1.55 3.42
C	92.5 3.64		23 0.91										2.1 4.63
D	109 4.29												2.3 5.07
E	55 2.17	36 1.42	27.5 1.08	-	357 14.06	384 15.12	400 15.75	26.5 1.04	8 0.31	16.5 0.65	8 0.31	263.5 10.37	3.3 7.28
G	65 2.56	46 1.81	32.5 1.28	-								265.3 10.44	4.9 10.8
H	130 5.12	111 4.37	27.5 1.08	75 2.95								265.3 10.44	9.05 19.95

Figure 1 - Package dimensions

3.3 Connector locations

X1 / X1A Power

Single-phase models

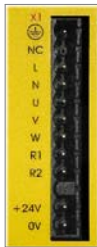

⊕	Earth
⊖	NC
L	AC Line
N	AC Neutral
U	Motor U
V	Motor V
W	Motor W
R1	} Regen Resistor
R2	
-	(NC)
+24V	Customer
0V	supplied 24V
	(FDHxxxxx-xxx3 / FPHxxxxx-xxx3)

Three-phase models, 230-460V



⊕	Earth
⊖	Earth
L1	AC Phase 1
L2	AC Phase 2
L3	AC Phase 3
U	Motor U
V	Motor V
W	Motor W
R1	} Regen Resistor
R2	
+24V	Customer supplied 24V
0V	(FDH4xxxx-xxx3 / FPH4xxxx-xxx3)

Three-phase models, 230V



⊕	Earth
⊖	Earth
L1	AC Phase 1
L2	AC Phase 2
L3	AC Phase 3
U	Motor U
V	Motor V
W	Motor W
Vcc+	(NC)*
Vcc-	(NC)*
R1	} Regen Resistor
R2	
+24V	Customer supplied 24V
0V	(FDH2xxxx-xxx3 / FPH2xxxx-xxx3)

* **Warning!** High voltages are present on terminals labeled Vcc+ and Vcc-. Do not make a connection to these terminals.

(NC) = Not Connected. Do not make a connection to this pin.

Tightening torque for terminal block connections is 0.5-0.6Nm (4.4-5.3 lb-in)

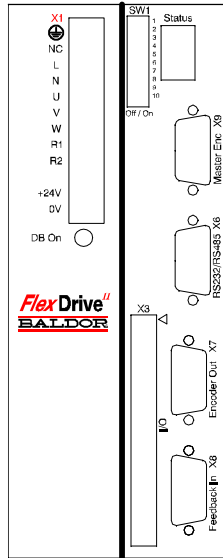

X9 Master Encoder

Encoder	Pulse & Dir.
1	CHA+ Pulse+
2	CHB+ Dir.+
3	CHZ+ (NC)
4	(NC) (NC)
5	DGND (NC)
6	CHA- Pulse GND
7	CHB- Dir. GND
8	CHZ- (NC)
9	+5V (NC)

X6 RS232/RS485

RS232	RS485/422
1	(NC) (NC)
2	RXD RX-
3	TXD TX-
4	(NC) (NC)
5	0V GND 0V DGND
6	(NC) (NC)
7	RTS TX+
8	CTS RX+
9	(NC - see section 4.4.3)

X7 Encoder Out

1	CHA+
2	CHB+
3	CHZ+
4	(NC)
5	DGND
6	CHA-
7	CHB-
8	CHZ-
9	(NC)

X8 Feedback In

Resolver option

1	REF+
2	COS+
3	SIN+
4	(NC)
5	AGND
6	REF-
7	COS-
8	SIN-
9	Chassis

Encoder options

	Incremental	EnDat	Hiperface
1	CHA+	Data+	Data+
2	CHB+	Data-	Data-
3	CHZ+	+5V	+8V
4	Hall U+	+5V	+8V
5	Hall U-	DGND	DGND
6	CHA-	Shield	Shield
7	CHB-	Cos B-	Cos B-
8	CHZ-	(NC)	(NC)
9	Hall W+	Clock-	(NC)
10	Hall V+	Clock+	(NC)
11	+5V	DGND	DGND
12	(NC)	Sin A-	Sin A-
13	DGND	Sin A+	Sin A+
14	Hall W-	Cos B+	Cos B+
15	Hall V-	(NC)	(NC)

Options:

If there are other connectors on the front panel of your FlexDrive^{II}, then an option is fitted. See the other manuals supplied with your FlexDrive^{II}.

3.4 Power connections

This section provides instructions for connecting the AC power supply. It is important that you refer to the correct front panel for your FlexDrive^{II} package.

The installer of this equipment is responsible for complying with NEC (National Electric Code) guidelines or CE (Conformite Europeene) directives and application codes that govern wiring protection, earthing/grounding, disconnects and other current protection.



WARNING: Electrical shock can cause serious or fatal injury. Do not touch any power device or electrical connection before you first ensure that power has been disconnected and there is no high voltage present from this equipment or other equipment to which it is connected.

The power supply module within all FlexDrive^{II} models provides rectification, smoothing and current surge protection. On 2.5A and 5A models a regeneration resistor (Dynamic Brake resistor) is also built-in. The power stage is internally fused and therefore self protected, but fuses or circuit breakers are required in the input lines for cable protection (depending on local codes and regulations).

A power disconnect should be installed between the AC supply and the input of the FlexDrive^{II} for a fail safe method to disconnect power. On models with the internally generated 24VDC logic supply (catalog numbers FDHxxxxx-xxx0 and FPHxxxxx-xxx0), the FlexDrive^{II} will remain operational until the internal bus voltage is depleted. Position and I/O information will then be lost. On models with an external customer supplied 24VDC logic supply (catalog numbers FDHxxxxx-xxx3 and FPHxxxxx-xxx3), position and I/O information will be retained while the 24V supply is present.

Note: A Residual Current Device (RCD) must not be used for fusing the drive. A circuit breaker or fuse must be used.

All interconnection wires should be in metal conduits between the FlexDrive^{II}, AC power source, motor, host controller and any operator interface stations. Use UL listed closed loop connectors that are of appropriate size for the wire gauge being used. Connectors are to be installed using only the crimp tool specified by the manufacturer of the connector.

Baldor drives are designed to be powered from standard single and three-phase lines (depending on model) that are electrically symmetrical with respect to earth/ground. Due to the importance of system earthing/grounding for increased reliability, earthing/grounding methods are shown in sections 3.4.1 and 3.4.2.

Note: When using unearthed/ungrounded distribution systems, an isolation transformer with an earthed/grounded secondary is recommended. This provides three-phase AC power that is symmetrical with respect to earth/ground and can prevent equipment damage.

FlexDrive^{II} may also be powered from a DC supply. However, details are not provided here since output current derating and other important limitations apply when using a DC supply. Please contact Baldor technical support for advice.

3.4.1 Single-phase connection to package sizes A, B, C, D

Location	Connector X1 (Mating connector: Phoenix COMBICON MVSTBW 2,5/9-ST, 5mm pitch)	
Part number	FDH1A... / FPH1A...	FDH2A... / FPH2A...
Nominal input voltage	115VAC, 1 Φ line to neutral (U.S. single phase supply)	230VAC, 1 Φ line to neutral (European single phase supply)*
Range	75-125VAC	75-250VAC

* The required 230VAC supply may also be derived from two phases of a U.S. 230VAC 3-phase supply, i.e. 230VAC line to line. Connect one phase to L and the other phase to N.

For single-phase connection, the voltage ripple on the DC-bus is 25Vp-p for 5A peak current rising to 50Vp-p for 10A peak current. This can limit the maximum speed of the motor. Tightening torque for terminal block connections is 0.5-0.6Nm (4.4-5.3 lb-in).

The threaded hole in the top of the enclosure is for protective earth/ground connections. The threaded hole in the bottom of the enclosure may be used as an additional functional earth/ground connection for signals on connector X3. It may also be used to attach strain relief clamps. The holes are threaded for M4 bolts no longer than 12mm (0.47 in) in length. Longer bolts may short circuit the electrical components inside the FlexDrive^{II}.

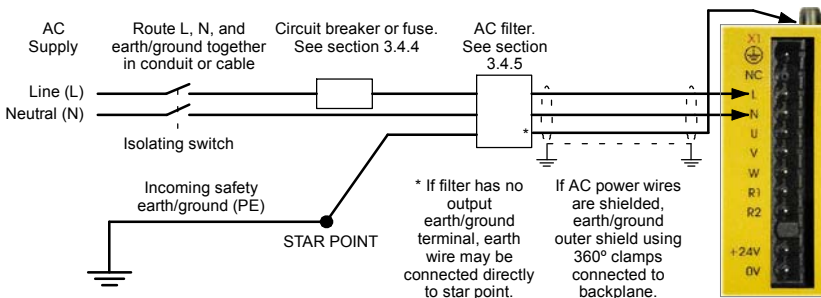

Figure 2 - Earthing/grounding for single-phase installations

Note: For CE compliance, a filter must be connected between the AC power supply and the FlexDrive^{II}. If local codes do not specify different regulations, use at least the same gauge wire for earth/ground as is used for L and N.

3.4.2 Three-phase connection to package sizes E, G, H

Location	Connector X1A (Mating connector: Phoenix POWER COMBICON PC4/...-ST- 7.62)	
Part number	FDH2A15... / FPH2A15...	FDH4A... / FPH4A...
Nominal input voltage	230VAC, 3 Φ line to line	230-460VAC, 3 Φ line to line
Range	75-253VAC	75-528VAC

Tightening torque for terminal block connections is 0.5-0.6Nm (4.4-5.3 lb-in). The threaded hole in the top of the enclosure is for protective earth/ground connections. The threaded hole in the bottom of the enclosure (if present) may be used as an additional functional earth/ground connection for signals on connector X3. It may also be used to attach strain relief clamps. The holes are threaded for M4 bolts no longer than 12mm (0.47 in) in length. Longer bolts may short circuit the electrical components inside the FlexDrive^{II}.

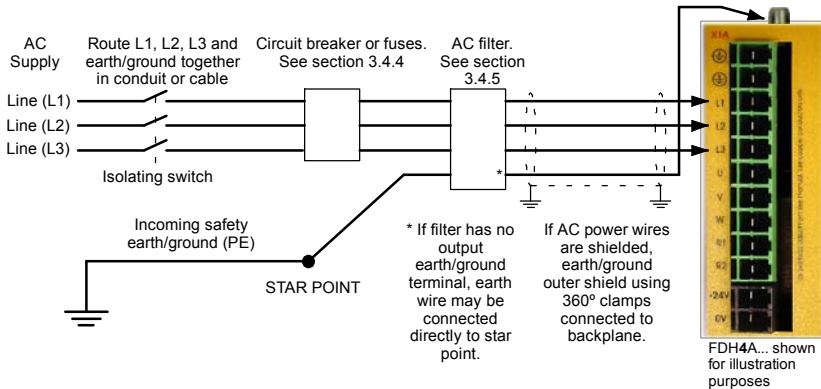

Figure 3 - Earthing/grounding for three-phase installations



WARNING: Drives with part numbers FDH2A15... or FPH2A15... have two additional terminals on the X1 connector labeled Vcc+ and Vcc-. The full DC bus output voltage is present on these terminals so do not make any connection to them.

Note: For CE compliance, a three-phase AC filter must be connected between the AC power supply and the FlexDrive^{II}. If local codes do not specify different regulations, use at least the same gauge wire for earth/ground as is used for L and N.

3.4.3 Input power conditioning

Baldor drives are designed for direct connection to standard single and three-phase lines (depending on model) that are electrically symmetrical with respect to earth/ground. Certain power line conditions must be avoided; an AC line reactor, an isolation transformer or a step up/step down transformer may be required for some power conditions:

- If the feeder or branch circuit that provides power to the FlexDrive^{II} has permanently connected power factor correction capacitors, an input AC line reactor or an isolation transformer must be connected between the power factor correction capacitors and the FlexDrive^{II}.
- If the feeder or branch circuit that provides power to the FlexDrive^{II} has power factor correction capacitors that are switched on line and off line, the capacitors must not be switched while the drive is connected to the AC power line. If the capacitors are switched on line while the drive is still connected to the AC power line, additional protection is required. A Transient Voltage Surge Suppressor (TVSS) of the proper rating must be installed between the AC line reactor (or isolation transformer) and the AC input to the FlexDrive^{II}.

3.4.3.1 Input power-cycling

If AC power has been removed from the FlexDrive^{II}, it should not be reapplied for at least one minute. This delay allows the input surge protection circuit to perform correctly. Power-cycling the drive more frequently could cause nuisance trips when power is reapplied and reduce the lifetime of the FlexDrive^{II}.

3.4.4 Power disconnect and protection devices

A power disconnect should be installed between the input power service and the FlexDrive^{II} for a fail-safe method to disconnect power. The FlexDrive^{II} will remain in a powered condition until all input power is removed from the drive and the internal bus voltage has depleted.

The FlexDrive^{II} must have a suitable input power protection device installed. Recommended circuit breakers are thermal magnetic devices (1 or 3 phase as required) with characteristics suitable for heavy inductive loads (D-type trip characteristic). Recommended time delay fuses are Buss FRN on 230VAC or equivalent. Dual element, time delay fuses should be used to avoid nuisance trips due to inrush current when power is first applied.

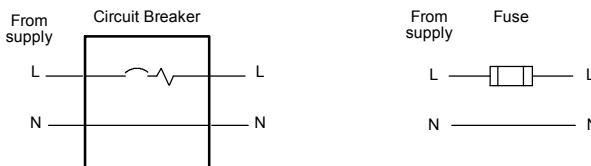

Figure 4 - Circuit breaker and fuse, single-phase (package sizes A, B, C, D)

Note: Power to single phase models may be derived by connecting two phases of an appropriate three-phase supply (L1 and L2 for example). When supplying AC power in this way, the voltage between the two phases must not exceed the rated input voltage of the FlexDrive^{II}. A two pole breaker must be used to isolate both lines. Fuses must be fitted in both lines. Circuit breaker or fuse are not supplied. For CE compliance, see Appendix D.

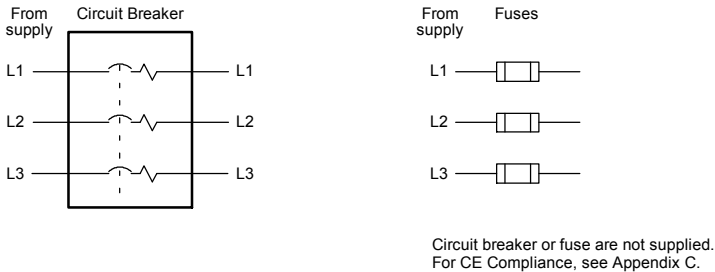

Figure 5 - Circuit breaker and fuse, three-phase (package sizes E, G, H)

Note: Metal conduit or shielded cable should be used. Connect conduits so the use of a line reactor or RC device does not interrupt EMI/RFI shielding.

3.4.5 Power supply filters

To comply with EEC directive 89/336/EEC, an AC power filter of the appropriate type must be connected. This can be supplied by Baldor and will ensure that the FlexDrive^{II} complies with the CE specifications for which it has been tested. Table 1 lists the appropriate filters:

FlexDrive ^{II} current rating	Input voltages			
	115VAC, 1Φ	230VAC, 1Φ	230VAC, 3Φ	230-460VAC, 3Φ
2.5A	FI0015A00 or FI0029A00			FI0018A00
5A	FI0015A02 or FI0029A00			FI0018A00
7.5A	FI0029A00			FI0018A00
15A			FI0018A01	FI0018A01
20A				FI0018A01
27.5A				FI0018A01

Table 1 - Baldor filter part numbers

All single-phase FlexDrive^{II} models can be mounted directly onto the body of filter FI0029A00, reducing the amount of panel area required for filter and drive.

3.4.6 Wire sizes and protection device ratings

Table 2 describes the wire sizes to be used for AC input power and motor output connections, together with the ratings for protection devices.

Catalog Number	Incoming Power					
	Nominal Input Voltage	Continuous Output Amps (RMS)	D-Type Input Breaker (A)	Time Delay Input Fuse (A)	Minimum Wire Gauge	
					AWG	mm ²
FDH1A02xx-xxxx FPH1A02xx-xxxx	115V (1Φ)	2.5A	6	6	14	2.0
FDH2A02xx-xxxx FPH2A02xx-xxxx	230V (1Φ)	2.5A	6	6	14	2.0
FDH1A05xx-xxxx FPH1A05xx-xxxx	115V (1Φ)	5A	10	10	14	2.0
FDH2A05xx-xxxx FPH2A05xx-xxxx	230V (1Φ)	5A	10	10	14	2.0
FDH1A07xx-xxxx FPH1A07xx-xxxx	115V (1Φ)	7.5A	16	16	14	2.0
FDH2A07xx-xxxx FPH2A07xx-xxxx	230V (1Φ)	7.5A	16	16	14	2.0
FDH4A02xx-xxxx FPH4A02xx-xxxx	230-460V (3Φ)	2.5A	6	6	14	2.0
FDH4A05xx-xxxx FPH4A05xx-xxxx	230-460V (3Φ)	5A	10	10	14	2.0
FDH4A07xx-xxxx FPH4A07xx-xxxx	230-460V (3Φ)	7.5A	16	16	14	2.0
FDH2A15xx-xxxx FPH2A15xx-xxxx	230V (3Φ)	15A	32	32	12	3.3
FDH4A15xx-xxxx FPH4A15xx-xxxx	230-460V (3Φ)	15A	32	32	12	3.3
FDH4A20xx-xxxx FPH4A20xx-xxxx	230-460V (3Φ)	20A	40	40	10	5.3
FDH4A27xx-xxxx FPH4A27xx-xxxx	230-460V (3Φ)	27.5A	60	60	10	5.3

Table 2 - Protection device and wire ratings

Note: All wire sizes are based on 75°C (167°F) copper wire. Higher temperature smaller gauge wire may be used per National Electric Code (NEC) and local codes. Recommended fuses/breakers are based on 25°C (77°F) ambient, maximum continuous control output current and no harmonic current. Earth/ground wires must be the same gauge, or larger, than the Line and Neutral wires.

3.4.7 External customer supplied 24V control supply

Depending on model (catalog numbers FDHxxxxx-xxx3 and FPHxxxxx-xxx3) a 24VDC control supply must be provided to power the control electronics. This is useful for safety reasons where AC power needs to be removed from the power stage but the control electronics must remain powered to retain position and I/O information. It is recommended that a separate fused 24V supply is provided for the FlexDrive^{II}. If other devices are likely to be powered from the same 24V supply then a filter (Baldor catalog number FI0014A00) should be installed to isolate the FlexDrive^{II} from the rest of the system.

Location	Connector X1 / X1A
Part number	FDHxxxxx-xxx3 or FPHxxxxx-xxx3
Nominal input voltage	24V
Range	20.4-28.8VDC
Input current (maximum)	1.75A continuous (4A power on surge)

Tightening torque for terminal block connections is 0.5-0.6Nm (4.4-5.3 lb-in)

Note: Connect 24V to connector X1 only if your model has this feature. Connecting 24V to a model that does *not* require an external 24V supply (FDHxxxxx-xxx0 and FPHxxxxx-xxx0) could damage the unit.

Note: The label on filter FI0014A00 *correctly* indicates that it is designed for connection to AC power supplies. However, this filter has been tested and is suitable for use with a 24VDC input as indicated in Figure 6. Do not attempt to use an alternative AC power filter as a 24VDC input filter.

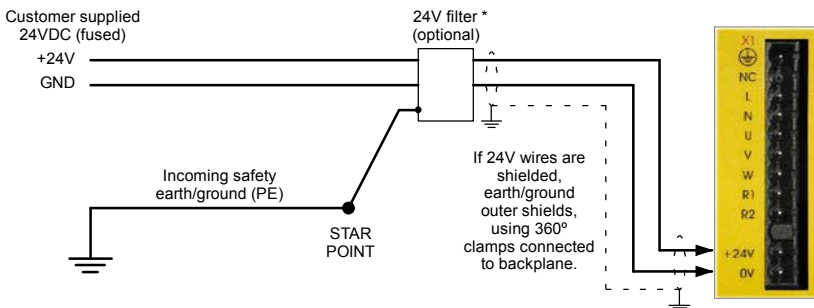

* An AC input voltage is indicated on the label of filter FI0014A00, but it may also be used with a 24VDC input.

Single-phase model shown for illustration purposes

Figure 6 - Customer supplied 24V supply connections

3.5 Motor connections

The motor can be connected directly to the FlexDrive^{II} or through a motor contactor (M-Contactor).

Location	Connector X1 / X1A			
Part number	FDH1A... FPH1A...	FDH2A... FPH2A...	FDH2A15... FPH2A15...	FDH4A... FPH4A...
Nominal output voltage	160VDC	320VDC	320VDC	565/650V
Output voltage range	135-176VDC	306-350VDC	258-355VDC	254-746VDC

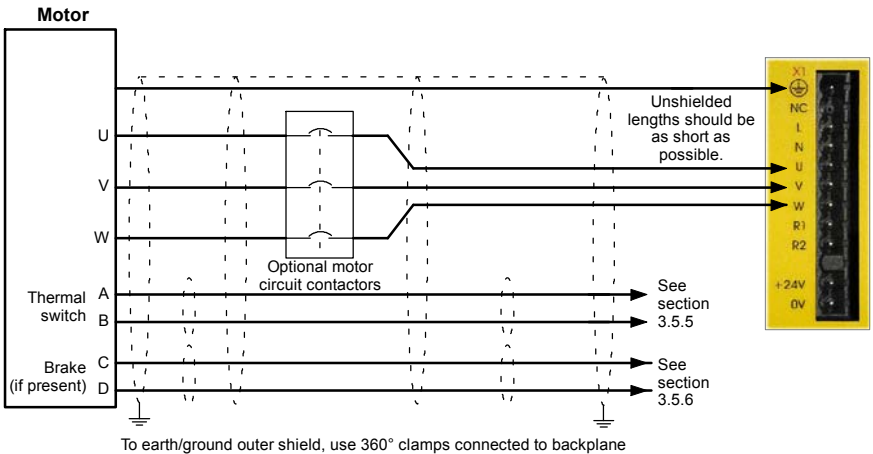

Figure 7 - Motor connections



CAUTION: Do not connect supply power to the FlexDrive^{II} UVW outputs. The FlexDrive^{II} might be damaged.



CAUTION: The motor leads U, V and W must be connected to their corresponding U, V or W terminal on the motor. Misconnection will result in uncontrolled motor movement.

The motor power cable must be shielded for CE compliance. The connector or gland used at the motor must provide 360 degree shielding. The maximum recommended cable length is 30.5m (100ft). For recommended motor power cable sizes, see section 3.4.6.

Note: For CE compliance the motor earth/ground should be connected to the drive earth/ground.

3.5.1 Motor circuit contactors

If required by local codes or for safety reasons, an M-Contactor (motor circuit contactor) may be installed to provide a physical disconnection of the motor windings from the FlexDrive^{II} (see section 3.5). Opening the M-Contactor ensures that the FlexDrive^{II} cannot drive the motor, which may be necessary during equipment maintenance or similar operations. Under certain circumstances, it may also be necessary to fit a brake to a rotary motor. This is important with hanging loads where disconnecting the motor windings could result in the load falling. Contact your local supplier for details of appropriate brakes.



CAUTION: If an M-Contactor is installed, the FlexDrive^{II} must be disabled at least 20ms before the M-Contactor is opened. If the M-Contactor is opened while the FlexDrive^{II} is supplying voltage and current to the motor, the FlexDrive^{II} may be damaged. Incorrect installation or failure of the M-Contactor or its wiring may result in damage to the FlexDrive^{II}.

Ensure that shielding of the motor cable is continued on both sides of the contactor.

3.5.2 Motor power cable pin configuration - Baldor BSM rotary motors

Figure 8 shows the pin configuration for a typical Baldor motor cable, part number CBL025SP-12:

Signal name	Motor / cable pin	Motor cable wire color
Motor U	1	Black, labeled '1'
Motor V	4	Black, labeled '2'
Motor W	3	Black, labeled '3'
Earth/ground	2	Green/Yellow
Thermal switch	A	Green
Thermal switch	B	White
Brake	C	Blue
Brake	D	Red

Note:
Not all motors are fitted with a brake so pins C and D might not be connected.

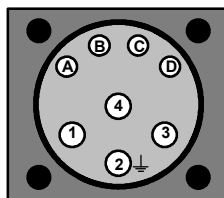

Motor power connector (male)

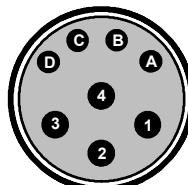

Cable connector end view (female)

Figure 8 - Baldor motor power cable pin configuration

3.5.3 Motor cable pin configuration - Baldor linear motors

The following table shows the pin colors used in a typical Baldor linear motor cable set, part number AY1763A00:

Signal name	Motor cable wire color
Motor U	Black
Motor V	Red
Motor W	White
Motor ground	Green
Thermal switch	Blue
Thermal switch	Orange

Signal name	Hall cable wire color
Hall 1 (U)	White
Hall 2 (V)	Red
Hall 3 (W)	Black
Hall ground	Green
Hall +5VDC	Brown

3.5.4 Sinusoidal filter

A sinusoidal filter is used to provide a better quality waveform to the motor, reducing motor noise, temperature and mechanical stress. It will reduce or eliminate harmful dV/dt values (voltage rise over time) and voltage doubling effects which can damage motor insulation. This effect occurs most noticeably when using very long motor cables, for example 30m (100 ft) or more. Baldor motors intended to be used with drives are designed to withstand the effects of large dV/dt and overvoltage effects. However, if very long motor cables are unavoidable and are causing problems, then a sinusoidal filter may be beneficial.

3.5.5 Thermal switch connection

You might wish to wire the motor's thermal switch contacts (normally closed), using a relay, to a digital input on connector X3 (see section 4.3.1). Using the Mint WorkBench Digital I/O tool, the input can be configured to be the motor trip input. This allows the FlexDrive^{II} to respond to motor over-temperature conditions. The Mint keyword `MOTORTEMPERATUREINPUT` can also be used to configure a digital input for this purpose. A typical circuit, using DIN1 as the input, is shown in Figure 9.

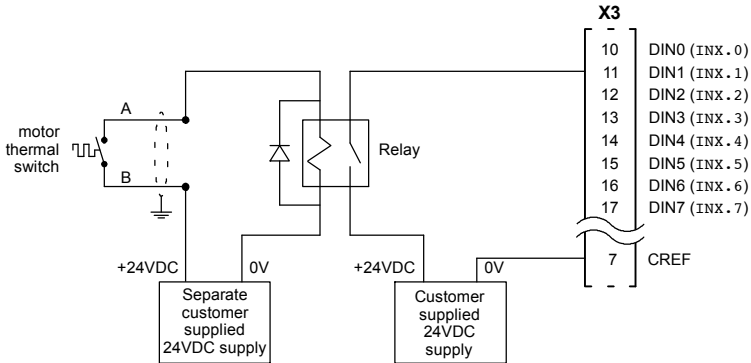

Figure 9 - Motor thermal switch circuit



CAUTION: The 24VDC power supply connected to the thermal switch must be a separate supply as shown in Figure 9. Do not use the 24V supply used for the drive enable signal, or the internally generated supply (if present). The thermal switch wires often carry noise that could cause erratic drive operation or damage. The thermal switch contacts must never be wired directly to a digital input.

The separate 24VDC supply used for the thermal switch may also be used for the motor brake circuit (section 3.5.6).

3.5.6 Motor brake connection

You might wish to wire a motor's brake, via relays, to digital outputs on connector X3 (see section 4.3.1). This provides a way for the Mint program to control the motor's brake. A typical circuit is shown in Figure 10. (**Flex+Drive^{II} only:** MOTORBRAKEOUTPUT and associated keywords may be used to configure the motor brake output.)

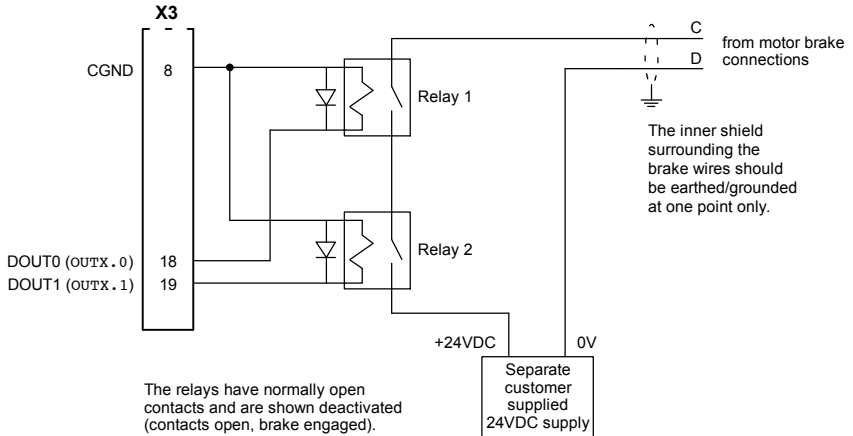

Figure 10 - Motor brake control circuit

This circuit uses the drive enable signal (configured using DRIVEENABLEOUTPUT to appear on DOUT0) in conjunction with DOUT1. With this configuration, the following sequences can be used to control the brake.

To engage the brake:

- The motor is brought to rest under normal control;
- Relay 2 is deactivated, causing the brake to engage;
- The drive is disabled. This removes power from the motor and causes Relay 1 to be deactivated.

To disengage the brake:

- The drive is enabled, activating Relay 1;
- Power is applied to the motor to hold position under normal control;
- Relay 2 is activated, causing the brake to be disengaged.

It may be necessary to include a small delay, after Relay 2 has been activated, before starting motion. This delay will allow time for the relay contacts to engage and the brake to release.



CAUTION: The 24VDC power supply must be a separate supply as shown in Figure 10. Do not use the 24V supply powering the FlexDrive^{II} digital outputs, or the internally generated supply (if present). The brake wires often carry noise that could cause erratic drive operation or damage. The brake contacts must never be wired directly to the digital outputs. The relay(s) should be fitted with a protective flyback diode, as shown. The separate 24VDC supply used for the motor brake may also be used to power the relay in the thermal switch circuit (section 3.5.5).

3.6 Regeneration resistor (Dynamic Brake resistor)

The 2.5A and 5A FlexDrive^{II} both have an internally fitted regeneration resistor *. For 7.5A, 15A, 20A and 27.5A FlexDrive^{II}, an external regeneration resistor must be installed to dissipate excess power from the internal DC bus during motor deceleration. When regeneration causes the DC bus voltage to rise by more than about 10-50 volts (model dependent) above the maximum allowable DC bus voltage, the regeneration resistor is automatically connected. When this happens, the yellow **DB On** LED on the front panel of the FlexDrive^{II} will illuminate.

The FlexDrive^{II} has an additional emergency overvoltage trip system. However, this must not be used as a means of protecting the drive from regeneration, since the trip occurs at a much higher voltage than the regeneration switching voltage. Allowing regeneration to cause regular overvoltage trips increases the chance of permanent damage to the FlexDrive^{II}.

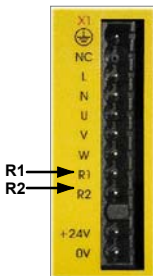

Suitable regeneration resistors are listed in section A.1.9.



WARNING: A regeneration resistor may generate enough heat to ignite combustible materials. To avoid fire hazard, keep all combustible materials and flammable vapors away from the resistors. The regeneration resistor should be mounted near the top of an enclosure to maximize heat dissipation. Baldor regeneration resistors are neither internally fused nor thermally protected and, under extreme conditions, can cause a fire hazard if not suitably protected or rated for the application.

* If required by the application, additional external resistors connected to R1 and R2 will be connected in parallel with the internal resistor.

3.6.1 Controlling regeneration

Some regeneration resistor assemblies include an overload switch to indicate when too much power is being dissipated by the resistor. This switch can be wired to a digital input on the FlexDrive^{II}. Using the Mint WorkBench Digital I/O tool, the input can be configured to be the brake trip input. This allows the FlexDrive^{II} to respond to resistor overload conditions.

The Mint keyword `DBEXTTRIPINPUT` can also be used to configure a digital input for this purpose. On three-phase FlexDrive^{II} models, the operation of the regeneration resistor can be controlled by further Mint keywords. These also begin with the letters `DB...`, for example `DBEXTPEAKPOWER`. See the Mint help file for details.

Alternatively, a thermostatic switch on the regeneration resistor can be used to disconnect the circuit breaker on the drive's ACpower input. This will prevent the drive from operating if the regeneration resistor overheats.

3.7 Feedback connections

Two feedback options are available for use with linear and rotary motors - commutating encoder or resolver. Confirm the catalog number of your FlexDrive^{II} (see section 2.2.1) to ensure you are wiring the correct feedback device. There are some important considerations when wiring the feedback device:

- The feedback device wiring must be separated from power wiring.
- Where feedback device wiring runs parallel to power cables, they must be separated by at least 76mm (3 in)
- Feedback device wiring must cross power wires at right angles only.
- To prevent contact with other conductors or earths/grounds, unearthed/ungrounded ends of shields must be insulated.
- Some larger D-type connector shells may be obstructed by neighboring connector X3.
- Linear motors use two separate cables (encoder and Hall). The cores of these two cables will need to be wired to the appropriate pins of the 15-pin D-type mating connector (supplied).

An encoder output signal is available on connector X7 for supplying other equipment. FlexDrive^{II} models with the resolver option provide a simulated encoder output, while the encoder based FlexDrive^{II} duplicates the encoder signals entering X8. See section 4.4.1 for details.

Flex+Drive^{II} only:

Flex+Drive^{II} models with the resolver or incremental encoder option are capable of dual encoder feedback, a technique where two encoders are used to control a single axis. The second feedback input is derived from the master (auxiliary) encoder input on connector X9 (section 4.4.2). See the Mint help file for details.

3.7.1 Resolver option - X8

The resolver connections are made using the 9-pin D-type male connector X8. Twisted pair cables must be used for the complementary signal pairs e.g. SIN+ and SIN-. The overall cable shield (screen) must be connected to the metallic shell of the D-type connector.

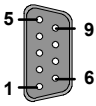

Location	Connector X8, 9-pin D-type male connector
Pin	Resolver function
1	REF+
2	COS+
3	SIN+
4	(NC)
5	Analog Ground
6	REF-
7	COS-
8	SIN-
9	Chassis Ground
Description	Resolver input with 14-bit resolution

The resolver input is used to create an encoder signal inside the FlexDrive^{II}. This provides the FlexDrive^{II} with an equivalent resolution of 4096 pulses per revolution (ppr), although this can be reconfigured in the Mint WorkBench Commissioning Wizard to provide 1024 ppr. The FlexDrive^{II} provides an input accuracy of ± 3 counts. When used with a typical Baldor BSM series resolver motor the combined accuracy is ± 11 counts (calculated with the input equivalent resolution set to the factory preset value of 4096 ppr).

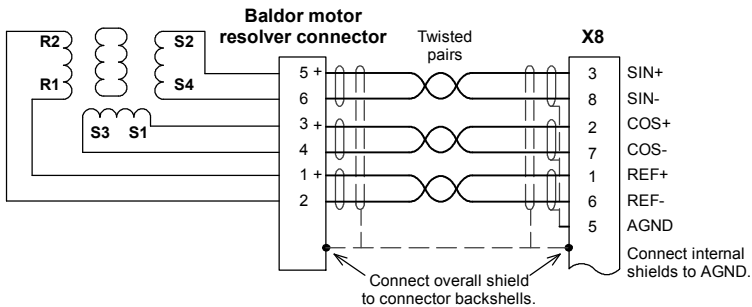

Figure 11 - Resolver cable connections

3.7.1.1 Resolver cable pin configuration

Figure 12 shows the pin configuration for a typical Baldor resolver feedback cable, part number CBL025SF-R1.

Signal name	FlexDrive ^{II} X8 pin	Motor / cable pin	Baldor resolver cable internal wire colors
REF+	1	1	Red
REF-	6	2	Blue
COS+	2	3	Green
COS-	7	4	Yellow
SIN+	3	5	Pink
SIN-	8	6	Grey

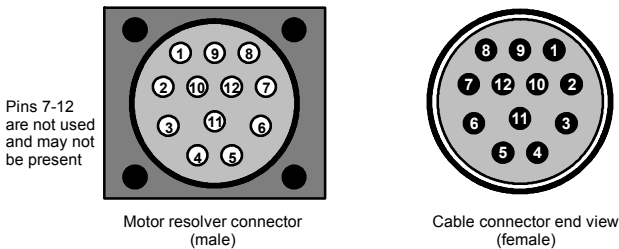
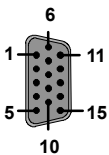

Figure 12 - Baldor motor resolver cable pin configuration

The maximum recommended cable length is 30.5m (100ft).

3.7.2 Encoder option - X8

The encoder connections (ABZ channels and Hall signals) are made using the 15-pin D-type female connector X8. Twisted pair cables must be used for the complementary signal pairs e.g. CHA+ and CHA-. The overall cable shield (screen) must be connected to the metallic shell of the D-type connector.



Location	Connector X8, 15-pin D-type female connector
Pin	Encoder function
1	CHA+
2	CHB+
3	CHZ+
4	Hall U+
5	Hall U-
6	CHA-
7	CHB-
8	CHZ-
9	Hall W+
10	Hall V+
11	+5V out
12	(NC)
13	DGND
14	Hall W-
15	Hall V-
Description	Commutating (UVW) encoder input, non-isolated. Pin 11 provides +5V for encoders requiring power (200mA max)

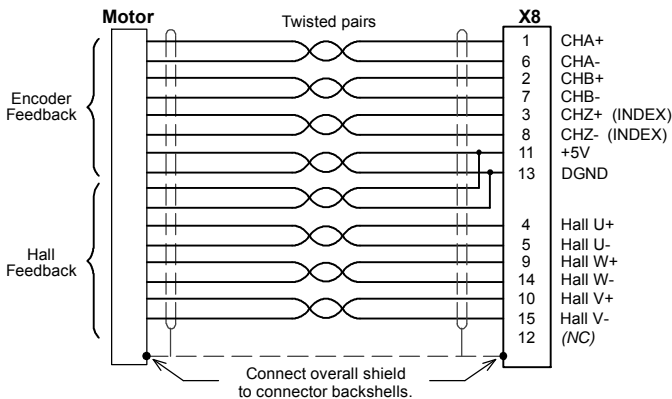

Figure 13 - Encoder cable connections - rotary motors

3.7.2.1 Encoder cable pin configuration - rotary motors

Figure 14 shows the pin configuration for a typical Baldor encoder feedback cable, part number CBL025SF-E1.

Signal name	FlexDrive ^{II} X8 pin	Motor / cable pin	Baldor encoder cable internal wire colors
CHA+	1	3	Purple
CHA-	6	4	Purple / White
CHB+	2	5	Green
CHB-	7	6	Green / White
CHZ+	3	7	Brown
CHZ-	8	8	Brown / White
Hall U+	4	10	Pink
Hall U-	5	11	Pink / Black
Hall V+	10	12	Yellow
Hall V-	15	13	Yellow / Black
Hall W+	9	14	Grey
Hall W-	14	15	Grey / Black
+5V	11	1	Red
DGND	13	2	Blue

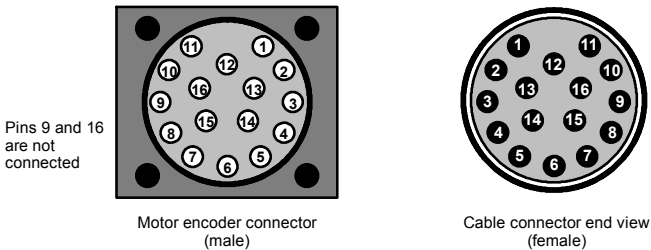

Figure 14 - Baldor rotary motor encoder cable pin configuration

The maximum recommended cable length is 30.5m (100ft).

3.7.2.2 Encoder cable connections - linear motors

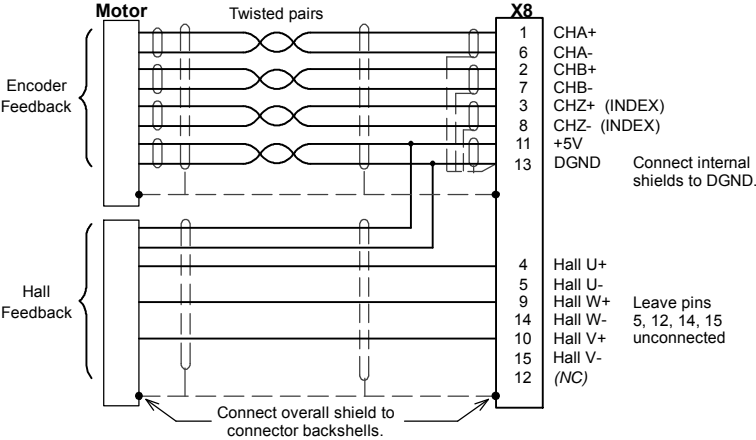

Figure 15 - Encoder cable connections - linear motors

3.7.2.3 Encoder cable pin configuration - linear motors

Linear motors use two separate cables (encoder and Hall). The cores of these two cables must be wired to the appropriate pins of the 15-pin D-type mating connector (supplied):

Signal name	FlexDrive ^{II} X8 pin	Encoder cable internal wire colors
CHA+	1	Please refer to MN1800 <i>Linear Motors Installation & Operating Manual</i> for details.
CHA-	6	
CHB+	2	
CHB-	7	
CHZ+	3	
CHZ-	8	
		Baldor Hall cable internal wire colors
Hall U+	4	White
Hall V+	10	Red
Hall W+	9	Black
+5V	11	Brown
Hall GND	13	Green

3.7.3 EnDat (absolute encoder) option - X8

The absolute encoder interface supports both incremental and absolute (multi and single turn) feedback using SinCos technology. It is possible to read and write information to the encoder. The absolute encoder connections are made using the 15-pin D-type female connector X8. Twisted pair cables must be used for the complementary signal pairs e.g. SinA+ and SinA-. The overall cable shield (screen) must be connected to the metallic shell of the D-type connector.

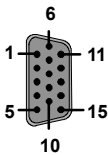

Location	Connector X8, 15-pin D-type female connector
Pin	Encoder function
1	Data+
2	Data-
3	+5V out
4	+5V out
5	DGND
6	Shield
7	Cos B-
8	<i>(Reserved - do not connect)</i>
9	Clock-
10	Clock+
11	<i>(Reserved - do not connect)</i>
12	Sin A-
13	Sin A+
14	Cos B+
15	<i>(Reserved - do not connect)</i>
Description	Absolute encoder input, non-isolated. Pin 4 provides power to the encoder (200mA max)

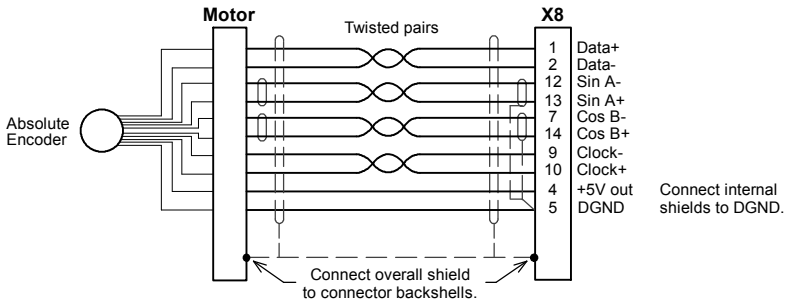
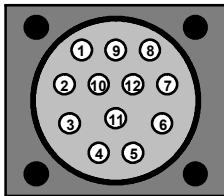

Figure 16 - EnDat absolute encoder cable connections

3.7.3.1 Absolute encoder cable pin configuration

Figure 17 shows the pin configuration for a typical Baldor absolute encoder feedback cable, part number CBL025SF-D1.

Signal name	FlexDrive ^{II} X8 pin	Motor / cable pin	Baldor EnDat cable internal wire colors
Data -	2	1	Brown / White
Sin A+	13	2	Green
Cos B+	14	4	Purple
Clock-	9	5	Pink / Black
Clock +	10	7	Pink
Cos B-	7	8	Purple / White
+5V	4	9	Red
DGND	5	10	Blue
Sin A-	12	11	Green / White
Data +	1	12	Brown



Motor absolute encoder connector
(male)

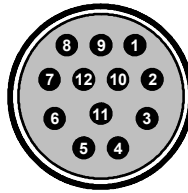

Cable connector end view
(female)

Figure 17 - Baldor rotary motor absolute encoder cable pin configuration

The maximum recommended cable length is 30.5m (100ft).

3.7.4 Hiperface (absolute encoder) option - X8

The Hiperface absolute encoder interface supports both incremental and absolute (multi and single turn) feedback using SinCos technology. It is possible to read and write information to the encoder. The absolute encoder connections are made using the 15-pin D-type female connector X8. Twisted pair cables must be used for the complementary signal pairs e.g. SinA+ and SinA-. The overall cable shield (screen) must be connected to the metallic shell of the D-type connector.



Location	Connector X8, 15-pin D-type female connector
Pin	Encoder function
1	Data+
2	Data-
3	+8V out
4	+8V out
5	DGND
6	Shield
7	Cos B-
8	<i>(Reserved - do not connect)</i>
9	<i>(Reserved - do not connect)</i>
10	<i>(Reserved - do not connect)</i>
11	DGND
12	Sin A-
13	Sin A+
14	Cos B+
15	<i>(Reserved - do not connect)</i>
Description	Hiperface absolute encoder input, non-isolated. Pin 3 provides power to the encoder (200mA max)

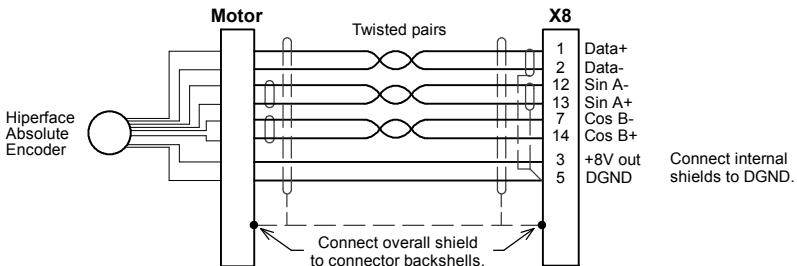
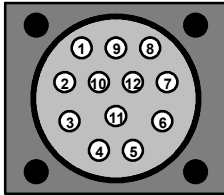

Figure 18 - Hiperface absolute encoder cable connections

3.7.4.1 Absolute encoder cable pin configuration

Figure 19 shows the pin configuration for a typical Baldor absolute encoder feedback cable, part number CBL025SF-D1.

Signal name	FlexDrive ^{II} X8 pin	Motor / cable pin	Baldor Hiperface cable internal wire colors
Data -	2	1	Brown / White
Sin A+	13	2	Green
Cos B+	14	4	Purple
Clock-	9	5	Pink / Black
Clock +	10	7	Pink
Cos B-	7	8	Purple / White
+8V	4	9	Red
DGND	5	10	Blue
Sin A-	12	11	Green / White
Data +	1	12	Brown



Motor absolute encoder connector
(male)

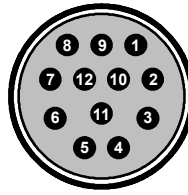

Cable connector end view
(female)

Figure 19 - Baldor rotary motor absolute encoder cable pin configuration

The maximum recommended cable length is 30.5m (100ft).

3.8 Drive enable - X3

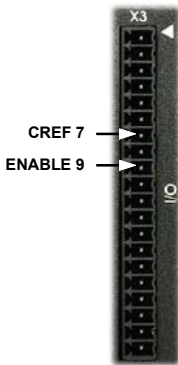

Location	Connector X3, pins 7 & 9 (Mating connector: Phoenix MINI-COMBICON MC 1.5/20-ST-3,5)
Name	Drive enable
Input voltage	+24VDC (±20%)

To enable the FlexDrive^{II} and allow motion, three actions are necessary:

- A customer supplied externally generated 24VDC supply must be connected between pins 7 and 9.
- The drive enable DIP switch (switch 8) must be in the On position.
- A drive enable command must be received.

These actions are explained in the following sections.

3.8.1 Drive enable - X3

The wiring to the drive enable input can be connected in one of two ways. Because CREF is common to all the digital inputs, this has an effect on the sense of DIN0 to DIN7. Either method provides a suitable drive enable input:

Active high

To cause the digital inputs to be active high (active when a voltage of +24VDC is applied to them) connect +24VDC to pin 9 and 0V to pin 7 (CREF).

Active low

To cause the digital inputs to be active low (active when grounded) connect +24VDC to pin7 (CREF) and 0V to pin 9.

The drive enable connection can be wired directly or through an intermediate switch. If a switch is used it should always be used to switch the signal to pin 9, with the signal to pin 7 (CREF) being hard-wired.

The sense of the digital inputs can also be configured in Mint WorkBench using the Digital inputs tab of the Digital I/O tool. Alternatively, the Mint `INPUTACTIVELEVEL` keyword can be used to select the sense of all the digital inputs (except drive enable). The state of the drive enable input is displayed in the Mint WorkBench Spy window. It can also be checked (but not set) using the Mint keyword `DRIVEENABLESWITCH`. See the Mint help file for details.

The drive enable input is rising edge triggered, but is only sampled every 1ms. For the drive to become enabled, the input signal must have been inactive (off) for at least one sample, and active (on) at the next sample. Care must be taken to avoid signal bounce on the drive enable input, since any falling edge detected after the drive has become enabled will disable the drive immediately. The drive cannot then be re-enabled until the input has been inactive (off) for at least one sample, as described above.

3.8.2 Drive enable - SW1 DIP switch

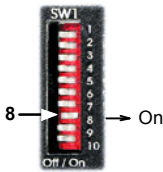

To enable the FlexDrive^{II} the front panel DIP switch 8 must be set to On. This switch provides a local enable/disable switch that can be useful during testing.

The state of the drive enable DIP switch is displayed in the Mint WorkBench Spy window. It can also be checked (but not set) using the Mint keyword `ENABLESWITCH`. See the Mint help file for details.

See section 3.9 for full details of other DIP switch functions.

3.8.3 Drive enable command

The other action required to enable the FlexDrive^{II} can be controlled either by software or hardware.

Note: This method is explained here for your information, but cannot be completed until you have installed the software and are ready to turn on AC power to the drive. Please continue to read all sections in sequence. Do not turn on AC power until you reach the appropriate instructions.

In software, a drive enable command must be issued. The easiest way to do this is by clicking the Drive enable button  in Mint WorkBench. Alternatively, the Mint commands `RESET` or `DRIVEENABLE=1` can be used. See the Mint help file for details.

In hardware, a digital input can be used to create the drive enable command. This can be configured in Mint WorkBench using the Digital inputs tab of the Digital I/O tool. Alternatively, the Mint keyword `RESETINPUT` can be used to select the required digital input. See the Mint help file for details. Digital inputs DIN0 - DIN7 are sampled every 2ms, so if one is used to provide the drive enable command it must be maintained for at least 2ms to ensure detection.

Another method is to use the Mint keyword `DRIVEENABLEMODE`. This allows the combination of DIP switch 8 and the Drive Enable input to create the drive enable command. Both inputs must become active. Provided one input is already on, as soon as the other input changes from off to on (active), the drive will be enabled. See the Mint help file for details.

3.9 DIP switches - SW1

Various functions of the FlexDrive^{II} can be controlled by the front panel SW1 DIP switches.



Location	Switch block SW1	
Switch	Function	
1	8	Node number selection (serial and fieldbus networks) <i>Bit pattern values shown in italics</i>
2	4	
3	2	
4	1	
5	Hold	
6	RS485 terminator	
7	Offset tuning	
8	Enable	
9	MODBUS select	
10	RS232/RS485 select	
Description	10-way DIP switch module for major functions	

3.9.1 Switches 1-4

Switches 1-4 set the network node number (address) after the next power off/on cycle. The switches can be used to select any node number from 1 to 14, as shown in Figure 20.

Switch 1	Switch 2	Switch 3	Switch 4	Node number (address)
Off	Off	Off	Off	Set by Mint NODE keyword
Off	Off	Off	On	1
Off	Off	On	Off	2
Off	Off	On	On	3
Off	On	Off	Off	4
Off	On	Off	On	5
Off	On	On	Off	6
Off	On	On	On	7
On	Off	Off	Off	8
On	Off	Off	On	9
On	Off	On	Off	10
On	Off	On	On	11
On	On	Off	Off	12
On	On	Off	On	13
On	On	On	Off	14
On	On	On	On	Do not use! See section 3.9.8

Figure 20 - Node number (address) switch settings

If switches 1-4 are all in the Off position, the Mint `NODE` keyword can be used to set the node number. Mint WorkBench (see section 5.2) reads the FlexDrive^{II} node number (during the scan process) and then uses it to direct commands to the FlexDrive^{II}.

Avoid accidentally setting switches 1-4 to the On position at the same time. In combination with DIP switch 8, this will reset the FlexDrive^{II} to its factory defaults. See section 3.9.8.

3.9.2 Switch 5 - Hold

Switch 5 stops the motor. In the Off position, normal operation is allowed. When switched to the On position, the motor decelerates to rest and maintains position. The switch position is sampled every 100ms.

3.9.3 Switch 6 - RS485 terminator

Switch 6 is used to connect a termination resistor to the RS485 network. In the Off position, the RS485 network is unterminated at the FlexDrive^{II}. In the On position, an internal 120Ω termination resistor is connected between the RX+ and RX- signals - see section 4.4.5. Switch 6 should remain in the Off position when using RS232.

3.9.4 Switch 7 - Offset tuning

Switch 7 is used to start offset tuning on analog (demand) input AIN0. The purpose of offset tuning is to remove DC offset voltages on analog input 0 (the demand reference input) to achieve a stationary motor shaft with 0VDC at the input. Confirm that the device supplying the AIN0 demand input is set to its intended zero output setting (nominally 0VDC) before starting offset tuning. When switch 7 is in the On position, offset tuning will start the next time Enable (switch 8) is changed from On to Off.

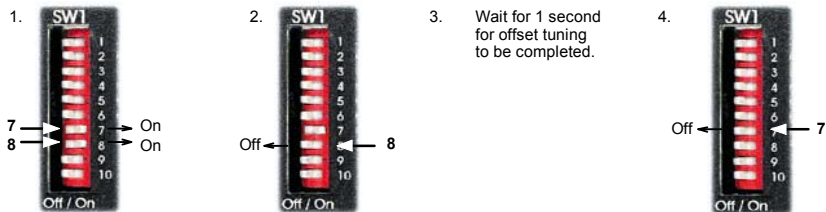

Figure 21 - Offset tuning using switch 7 and 8

Leave switch 7 Off in normal use. After offset tuning, remember to set switch 8 to the On position to allow the drive to be enabled. The switch positions are sampled every 100ms. The Mint keyword `ADCOFFSETTRIM` can be used to perform the same action.

3.9.5 Switch 8 - Enable

Switch 8 must be set to On to allow the drive to be enabled. The switch position is sampled every 100ms. However, two other actions are necessary to enable the FlexDrive^{II}:

- The enable input (see section 3.8) must be active.
- The drive must also be enabled by using a drive enable command (see section 3.8.3).

3.9.6 Switch 9 - MODBUS select

Switch 9 enables the MODBUS serial protocol the next time the FlexDrive^{II} is power-cycled. This affects the value of the Mint keyword SERIALPROTOCOL. Enabling MODBUS disables the Host Comms Protocol (HCP), so attempts to access the drive's comms array over the serial connection (using a serial HMI panel for example) will no longer work.

3.9.7 Switch 10 - RS232/RS485 select

Switch 10 selects RS232 communications (Off) or RS485/RS422 (On) the next time the FlexDrive^{II} is power-cycled.

3.9.8 Factory settings

If switches 1-4 are all in the On position and switch 8 is set to Off, the FlexDrive^{II} will be reset to its preset factory settings at power on (or whenever the processor is reset by Mint WorkBench).



CAUTION: Use this function carefully - it will erase your drive setup information.

When using the SW1 DIP switches to reset the FlexDrive^{II} to its factory defaults, all parameters including the node number and serial communications baud rate will be reset. In Mint WorkBench, this means it will be necessary to rescan for the FlexDrive^{II} (by starting a new project) to enable communication. It will also be necessary to re-tune your motor and drive.

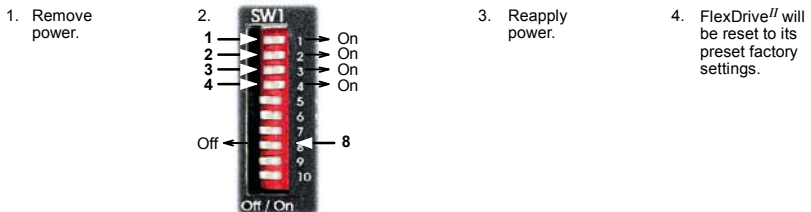

Figure 22 - Resetting the FlexDrive^{II} to its factory default settings

The Mint keyword FACTORYDEFAULTS can also be used to reset the FlexDrive^{II} to its factory defaults. However, it will not reset the node number or serial communications baud rate. See the Mint help file for details.

3.9.9 Preventing a program running at startup

Flex+Drive^{II} only:

If switches 5 and 9 are set to On and switch 8 is set to Off, any program already in the Flex+Drive^{II} that contains an Auto command will be prevented from running automatically at startup.

It is possible for normal (Baldor Binary Protocol) serial communication to be lost if bit 5 of the Mint keyword `COMMSMODE` has been set. This can occur when alternative communication protocols have been used. This DIP switch procedure will clear bit 5, restoring normal serial communication.

1. Remove power.

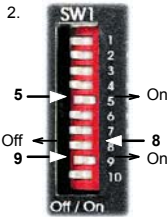

3. Reapply power. Mint program with Auto command will not run.

Figure 23 - Preventing the Auto command from running a stored Mint program, or restoring normal serial communication

4.1 Introduction

This section describes the various digital and analog input and output capabilities of the FlexDrive^{II}, with descriptions of each of the connectors on the front panel.

The following conventions will be used to refer to the inputs and outputs:

I/O	Input / Output
DIN	Digital Input
DOUT	Digital Output
AIN	Analog Input
AOOUT	Analog Output
CH	Encoder channel

4.2 Analog I/O

The FlexDrive^{II} provides as standard:

- 1 analog input on the connector block X3 (demand input)

The analog input is not optically isolated from internal power rails, so care must be taken to avoid earth/ground loops and similar associated problems. The input buffers provide low pass filtering of the applied voltage.

To minimize the effects of noise, the analog input signal should be connected to the system using individual shielded / screened cable (a twisted pair cable in the case of differential operation) with an overall shield. The overall shield should then be connected to the chassis at one end only. No other connection should be made to the shield.

If the input is unused, then it is advisable to connect it to the AGND pin. Do not leave the input unconnected (floating).

4.2.1 Analog input - X3 (demand)



Location	Connector X3, pins 1-3 (Mating connector: Phoenix MINI-COMBICON MC 1.5/20-ST-3,5)
Name	AIN0
Mint keyword	ADC . 0
Description	Single ended or differential input. Common mode voltage range: $\pm 10\text{VDC}$. Resolution: 14-bit with sign (accuracy $\pm 1.2\text{mV}$) Common mode rejection: 40dB Input impedance: $>5\text{k}\Omega$ Sampling interval: 500 μs - Software (Mint programs) 125 μs - High speed demand reference signal

Analog input X3 can be connected as either a differential or a single ended input as shown in Figure 24.

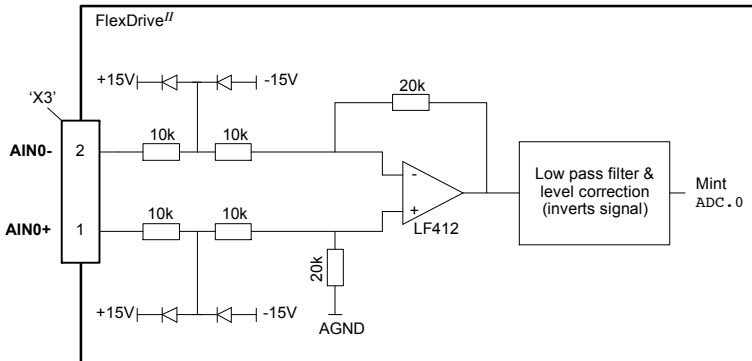

Figure 24 - AIN0 analog input circuit

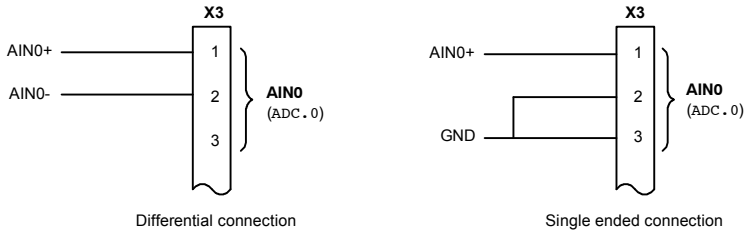

Figure 25 - AIN0 analog input wiring

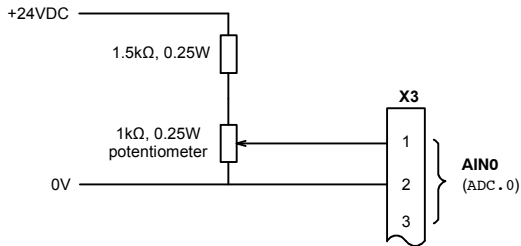

Figure 26 - Typical input circuit to provide 0-10V (approx.) input from a 24V source

4.3 Digital I/O

The FlexDrive^{II} provides as standard: *

- 8 general-purpose inputs on connector block X3
- 3 general-purpose outputs on connector block X3
- 1 relay / general-purpose output on connector block X3

A digital input can be used to support many typical input functions:

- Error input
- Reset input
- Stop input
- Forward limit
- Reverse limit
- Interrupts (controlled from Mint)
- Regeneration resistor (Dynamic Brake) overtemperature input
- PLC Task input conditions
- General purpose use.

Flex+Drive^{II} only:

- Home input
- Index selection and triggering for preset move types
- DIN4 and DIN5 are fitted with Schmitt trigger devices and can be configured using Mint for position capture of the axis or the master/auxiliary encoder positions. See section 4.3.4.
- The main axis' fast input (assigned using the Mint keyword FASTSELECT) can also be used as a trigger for point to point move types. See the Mint help file for details.

* Additional I/O is available on connector X12 if the CAN & Auxiliary I/O option is fitted. See MN1908 *CAN & Auxiliary I/O option for Flex+Drive^{II} and MintDrive^{II}*.

4.3.1 Digital inputs - X3

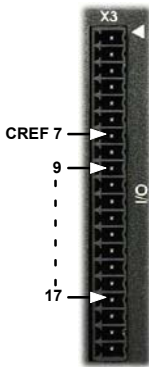

Location	Connector X3	
Pin	Name	Mint keyword
9	Drive Enable	-
10	DIN0	INX . 0
11	DIN1	INX . 1
12	DIN2	INX . 2
13	DIN3	INX . 3
14	DIN4	INX . 4
15	DIN5	INX . 5
16	DIN6	INX . 6
17	DIN7	INX . 7
Description	<p>Eight general-purpose optically isolated AC digital inputs. One committed drive enable input (Drive Enable). Sampling interval: Drive Enable input: 1ms DIN0 - DIN7: Equivalent to LOOPTIME (default 1ms):</p>	

The digital inputs DIN0 - DIN7 can be read individually using the associated Mint keyword INX (for example INX . 7) and can be configured for many user definable functions. Each input circuit contains an opto-isolator as shown in Figure 27. Inputs DIN4 and DIN5 can also be used as fast inputs - see section 4.3.4. The state of each digital input is displayed in the Mint WorkBench Spy window.

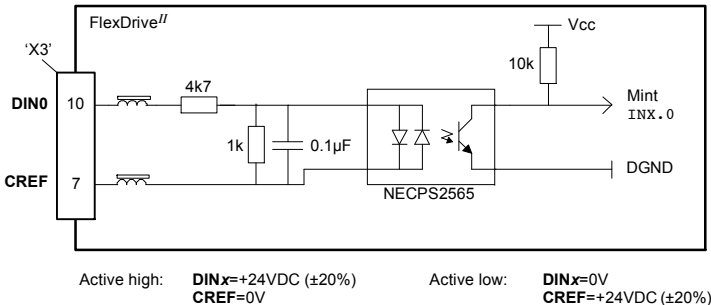

Figure 27 - X3 digital input circuit - DIN0 shown

4.3.2 CREF and digital inputs

Pin 7 (CREF) controls the sense of all the digital inputs (X3 pins 9 to 17) and should be permanently wired, dependent on the user requirements:

Active high: connect 0V to pin 7.

The digital inputs will be active when a voltage of +24VDC (greater than 12VDC) is applied to them and will sink a current of approximately 5mA each.

Active low: connect +24VDC to pin7.

The digital inputs will be active when grounded (less than 2V) and will source a current of approximately 5mA each.

The +24VDC supply is from a customer supplied 24VDC supply that should have a continuous current capability of 1.75A.

The sense of the inputs can be configured in Mint WorkBench or controlled individually in Mint using the keyword `INPUTACTIVELEVEL`.

See section 3.8 for more information about Drive Enable.

4.3.3 Special functions on DIN4 and DIN5 - pulse and direction inputs

DIN4 and DIN5 can be configured using the `MASTERSOURCE` keyword to behave as pulse and direction inputs:

- DIN4 is used as the pulse input. The pulse frequency controls the speed of the motor.
- DIN5 is used as the direction input. The state of the direction input controls the direction of motion. A positive voltage will result in forward motion. If DIN5 is grounded, movement will be in the opposite direction.

Note: If DIN4 and DIN5 have been configured as pulse and direction inputs, the alternative pulse and direction inputs, available on connector X9, cannot be used. See the Mint keyword `MASTERSOURCE`.

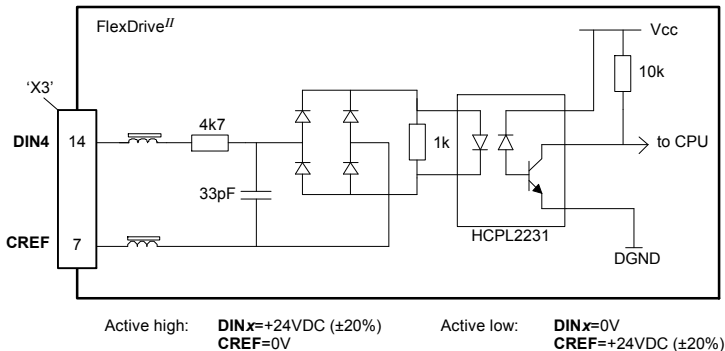

Figure 28 - X3 pulse and direction / fast digital input circuit

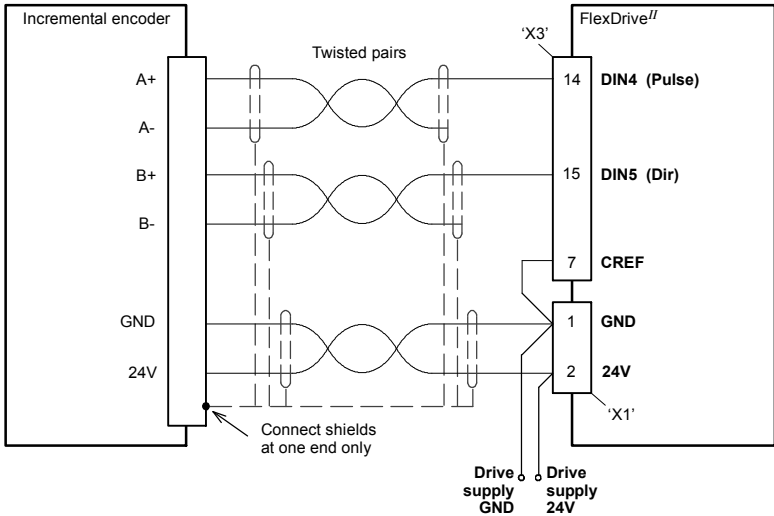

Figure 29 - Pulse and direction inputs - typical connection from an incremental encoder: FlexDrive II with external 24V supply option, 'active high' inputs

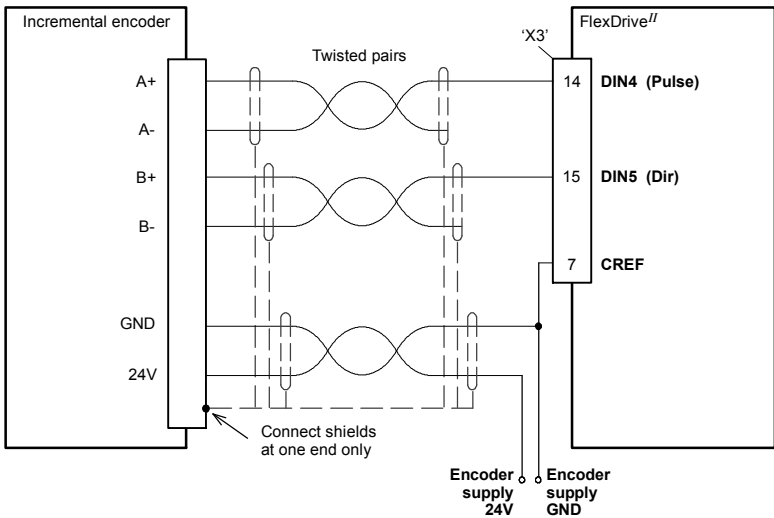

Figure 30 - Pulse and direction inputs - typical connection from an incremental encoder: FlexDrive II with internally generated 24V supply option, 'active high' inputs

Note: When using an incremental encoder source, do not connect the A- or B- outputs; leave them unconnected as shown in Figures 29 and 30.

4.3.4 Special functions on DIN4 and DIN5 - fast inputs

Flex+Drive^{II} only:

DIN4 and DIN5 can be configured using the `FASTSELECT` keyword to perform special functions:

- Fast interrupt hardware position capture input. The position of the axis is captured in real time and can be read using the Mint keyword `FASTPOS`.
- Master or auxiliary encoder input capture, read using the Mint keyword `FASTAUXENCODER` (DIN5 only).

The maximum latency to read the fast position is approximately 1 μ s. The fast interrupt will be latched on a pulse width of about 30 μ s, although a width of 100 μ s is recommended to ensure capture. To prevent subsequent inputs causing the captured value to be overwritten, the interrupt is latched in software. It is necessary to clear the latch before subsequent interrupts can be detected. See the Mint help file. Both inputs are fitted with Schmitt trigger devices.

Note: The fast inputs are particularly sensitive to noise, so inputs must use shielded twisted pair cable.

Do not connect mechanical switches, relay contacts or other sources liable to signal 'bounce' directly to the fast inputs. This could cause unwanted multiple triggering.

4.3.5 Digital outputs - X3

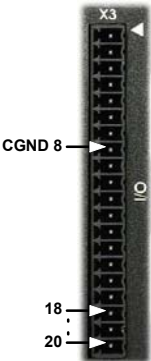
	Location	Connector X3	
	Pin	Name	Mint keyword
	18	DOUT0	OUTX . 0
	19	DOUT1	OUTX . 1
	20	DOUT2	OUTX . 2
	Description	<p>Three general-purpose optically isolated digital outputs. Output current: 50mA maximum each output</p> <p>Update intervals:</p> <p><u>Immediate</u>: Software (Mint programs)</p> <p><u>LOOPTIME (default 1ms)</u>: DRIVEENABLEOUTPUT, DRIVEOKOUTPUT and GLOBALERROROUTPUT functions.</p> <p>Outputs controlled by functions MOVEOUT, MOVEOUTX, MOVEPULSEOUTX, PULSEOUTX.</p> <p><u>Programmable</u>: PLC Task functions</p>	

Each optically isolated PNP output is designed to source current from the USR V+ supply as shown in Figure 31. The maximum saturated voltage across any of the outputs when active is 1.0VDC, so they can be used as TTL compatible outputs. If the outputs are used to directly drive a relay, a suitably rated flyback diode must be fitted across the relay coil, observing the correct polarity. This is to protect the output from the back-EMF generated by the relay coil when it is de-energized. The outputs can be written to directly using the Mint keyword `OUTX` (for example `OUTX . 2=1`). The sense of the outputs can be configured in Mint WorkBench, and their states are displayed in the Spy window.

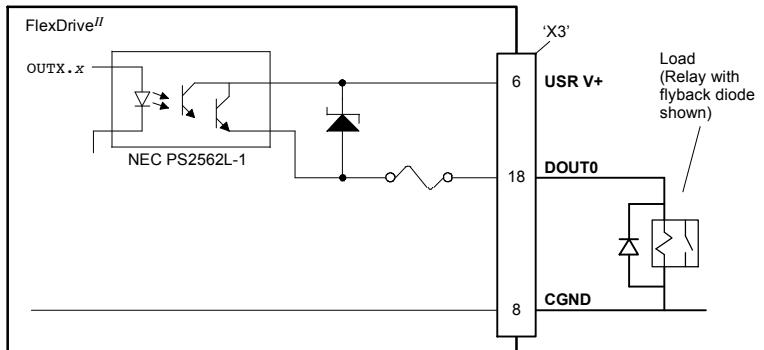

Figure 31 - X3 digital output circuit - DOUT0 shown

4.3.6 Relay output / digital output - X3



Location	Connector X3, pins 4 (+) & 5 (-)
Name	General purpose relay
Mint keyword	RELAY / OUTX . 3
Description	Relay switch contacts controlled by Mint, rated at 1A, 30VDC. Update intervals: <u>Immediate</u> : Software (Mint programs) <u>LOOPTIME (default 1ms)</u> : DRIVEENABLEOUTPUT, DRIVEOKOUTPUT and GLOBALERROROUTPUT functions. Outputs controlled by functions MOVEOUT, MOVEOUTX, MOVEPULSEOUTX, PULSEOUTX. <u>Programmable</u> : PLC Task functions

The factory preset assignment for the relay is as the global error output signal (see the Mint keyword GLOBALERROROUTPUT). When an error occurs the relay is de-energized and the contacts open. When the error is cleared, the relay is re-energized and the contacts close. The relay can be also be controlled directly by the Mint keyword RELAY. When the relay is energized (RELAY=_on) the contacts close. When the relay is de-energized (RELAY=_off) the contacts open. The relay output may also be considered as a digital output, so can be controlled directly using the Mint keyword OUTX (for example OUTX . 3=1).

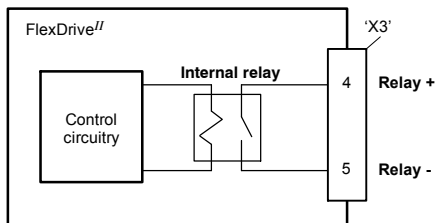

Figure 32 - Relay contact outputs

Note: The internal relay has a limited lifetime and is not intended for continuous cyclical operation. If relay operations are required more frequently than 4 - 5 times per hour, it is recommended to use one of the digital outputs to control a replaceable external relay.

4.4 Other I/O

4.4.1 Encoder output - X7



Location	Connector X7
Pin	Name
1	CHA+
2	CHB+
3	CHZ+
4	(NC)
5	DGND
6	CHA-
7	CHB-
8	CHZ-
9	(NC)
Description	Encoder output on a 9-pin female D-type connector

This output can be used for position feedback to a host positioner, or in master/slave situations where the axis movement can be transmitted to another controller or FlexDrive^{II}. Using connectors X7 and X8, multiple FlexDrive^{II} units (with the encoder feedback option) can be 'daisy-chained' together. It is recommended that this output only drives one output circuit load. The encoder outputs are differential and conform to the RS422 electrical specification. Shielded twisted pair cable is recommended.

If the resolver feedback option is fitted, a simulated encoder output is produced at X7. If the resolver input has been configured to simulate an encoder input of 1024 pulses per revolution (ppr), the output at X7 can be set to either 512 or 1024 ppr. If the resolver input has been configured to simulate an encoder input of 4096 ppr, output modes of 512, 1024, 2048 and 4096 ppr are possible. Note that these values represent actual encoder lines, not quadrature counts. The simulated encoder output is in the same direction as the resolver input. See the keyword `ENCODERLINESOUT` in the Mint help file.

If the basic encoder feedback option is fitted, X7 duplicates the encoder signals entering X8. However, the simulated encoder output is in the opposite direction to the encoder input. When connecting the output to another Baldor controller, the `ENCODERMODE` or `AUXENCODERMODE` keywords can be used to re-invert the signal.

If the EnDat or Hiperface (absolute encoder) feedback option is fitted, a simulated encoder output is produced at X7. The output ppr is equal to the number of Sin/Cos cycles of the absolute encoder. For example, if a 2048 cycle absolute encoder is connected, the output at X7 will be equivalent to a 2048 ppr encoder. Note that this value represents actual encoder lines, not quadrature counts. For EnDat, the simulated encoder output is in the same direction as the encoder input. For Hiperface, the simulated encoder output is in the opposite direction to the encoder input.

The encoder output supports an index or marker pulse.

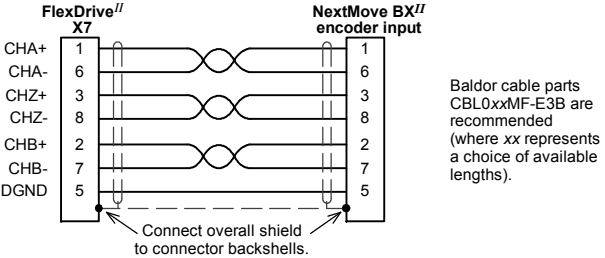

Figure 33 - FlexDrive^{II} encoder output to NextMove BX^{II} encoder input



CAUTION: If the older model NextMove BX (which has a gray case) is to be connected, a different cable must be used as shown in Figure 34:

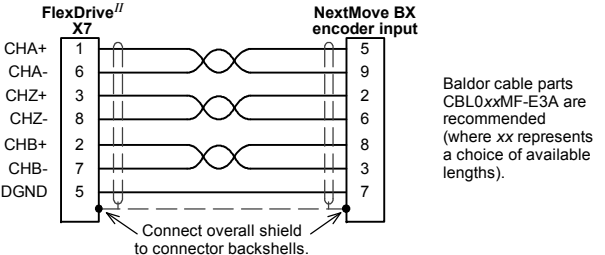

Figure 34 - FlexDrive^{II} encoder output to NextMove BX encoder input

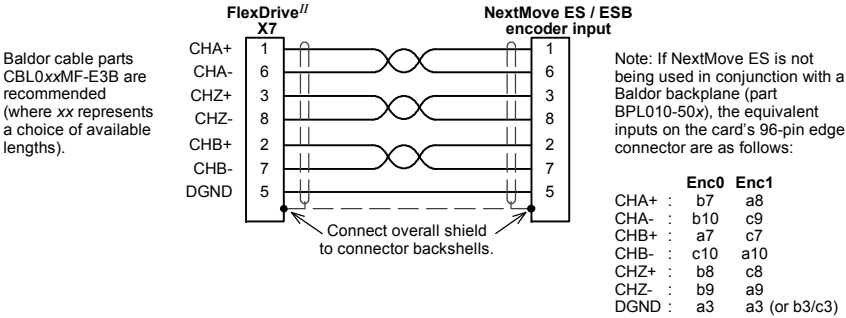
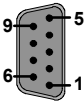

Figure 35 - FlexDrive^{II} encoder output to NextMove ES / ESB encoder input

4.4.2 Master (auxiliary) encoder input - X9



Location	Connector X9	
Pin	Encoder name	Pulse & direction name
1	CHA+	Pulse+
2	CHB+	Direction+
3	CHZ+	-
4	(NC)	-
5	DGND	-
6	CHA-	Pulse GND
7	CHB-	Direction GND
8	CHZ-	-
9	+5V out	-
Description	Optically isolated encoder or pulse and direction input on a 9-pin female D-type connector. Sampling interval: 1 or 2ms	

The FlexDrive// provides an auxiliary (master or handwheel) encoder input that allows it to follow a master encoder or pulse and direction inputs. An interface for a three-channel, incremental encoder (CHA, CHB, CHZ) is provided. The input receiver circuit allows only encoders with differential line drivers (RS422) to be used. The interface also provides an isolated 5V supply for the encoder electronics, capable of driving up to 100mA.



CAUTION: The master encoder input does not use the same pin configuration as some Baldor controllers such as NextMove BX

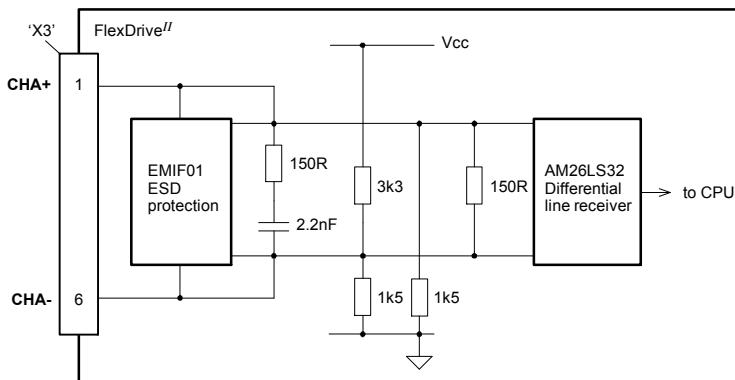

Figure 36 - Master encoder channel input circuit - Channel A shown

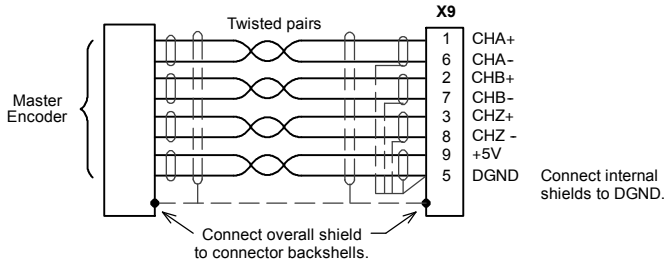

Figure 37 - Differential encoder connections

4.4.2.1 Dual encoder feedback

The master encoder input can be used as a second feedback input in dual encoder systems. The Mint keyword `AXISPOSENCODER` is used to select the master (auxiliary) encoder input as a feedback input. See the Mint help file for details.

4.4.2.2 Pulse and Direction following

The master encoder pulse and direction inputs accept 5V differential line driver (RS422) signals from an external source. The pulse frequency controls the speed, and the state of the direction signal controls the direction of motion. A positive direction voltage (greater than 200mV) will result in motion in one direction. A negative direction voltage (less than -200mV) will result in movement in the opposite direction.

The Mint keyword `AUXENCODERMODE` (bit 2) is used to configure X9 for pulse and direction input. If necessary, the sense of the direction input can be reversed in software using the Mint keyword `AUXENCODERMODE` (bit 0). See the Mint help file for details.

Note: If X9 has been configured for pulse and direction input, the alternative pulse and direction inputs, available on connector X3, cannot be used. See the Mint keyword `MASTERSOURCE`.

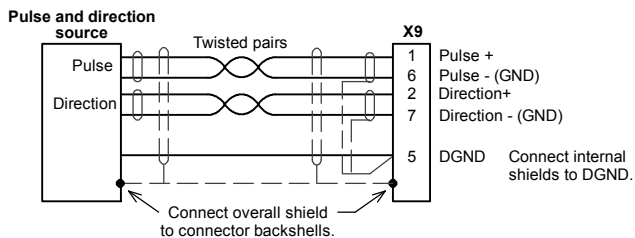
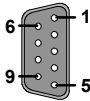

Figure 38 - Pulse and direction connections

4.4.3 Serial port - X6



Location	Connector X6	
Pin	RS232 name	RS485 / RS422 name
1	(NC)	(NC)
2	RXD	RX- (input)
3	TXD	TX- (output)
4	(NC)	(NC)
5	0V GND	0V DGND
6	(NC)	(NC)
7	RTS	TX+ (output)
8	CTS	RX+ (input)
9	<i>(Do not connect! See caution below)</i>	
Description	RS232 or RS485 / RS422 connections on a single 9-pin male D-type connector	

Connector X6 is a 9-pin male D-type connector. This port is configurable as either RS232 or 4-wire RS422 / RS485, using front panel DIP switch number 10 (see section 3.9.7). The Mint keyword `SERIALBAUD` is used to configure the port and is explained in the Mint help file. See also sections 4.4.4 and 4.4.5. The port is fully ESD protected to IEC 1000-4-2 (15kV).

When using RS485 / RS422 mode, front panel DIP switch number 6 may be used to connect an internal 120Ω termination resistor between the RX+ and RX- signals. Switch 6 should remain in the Off position when using RS232.



CAUTION: Pin 9 is used to carry +8V for powering certain Baldor keypad peripherals. Ensure that pin 9 is not connected to earth/ground or to equipment that could be damaged by the +8V supply.

4.4.4 Using RS232 cable



CAUTION: The serial connector on the FlexDrive^{II} (X6) can be configured as either RS232 or RS485 / RS422. Pin 9 is used to carry +8V for powering certain Baldor keypad peripherals. Ensure that pin 9 is not connected to earth/ground or to equipment that could be damaged by the +8V supply. A suitable cable is available from Baldor, catalog number CBL001-501.

Front panel DIP switch 10 must be in the Off position to select RS232 operation. The FlexDrive^{II} has a full-duplex RS232 serial port with the following preset configuration:

- 57.6Kbaud
- 1 start bit
- 8 data bits
- 1 stop bit
- No parity
- Hardware handshaking lines (RS232) RTS and CTS must be connected.

This configuration can be changed if required. The RS232 connections are brought out onto a 9-pin male D-type connector. The RS232 port is configured as a DTE (Data Terminal Equipment) unit. Both the output and input circuitry are single ended and operate between $\pm 12V$. The port is capable of operation at up to 57.6Kbaud.

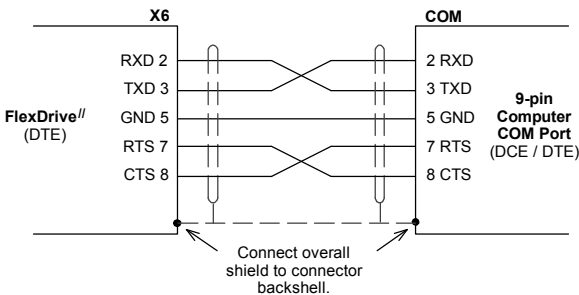

Figure 39 - RS232 serial port connections

The maximum recommended cable length is 3m (10ft) at 57.6Kbaud (the factory preset rate). When using lower Baud rates, longer cable lengths may be used up to maximum of 15m (49ft) at 9600 Baud.

4.4.5 Multidrop using RS485 / RS422 cable

Multidrop systems allow one device to act as a 'network master', controlling and interacting with the other (slave) devices on the network. The network master can be a controller such as a FlexDrive^{II}, a host application such as Mint WorkBench (or other custom application), or a programmable logic controller (PLC). RS422 may be used for multi-drop applications as shown in Figure 40. Four-wire RS485 may be used for single point-to-point applications involving only one Baldor controller. If firmware is updated over RS485/RS422, it can only be downloaded to the drive that was chosen in the Select Controller dialog in Mint WorkBench.

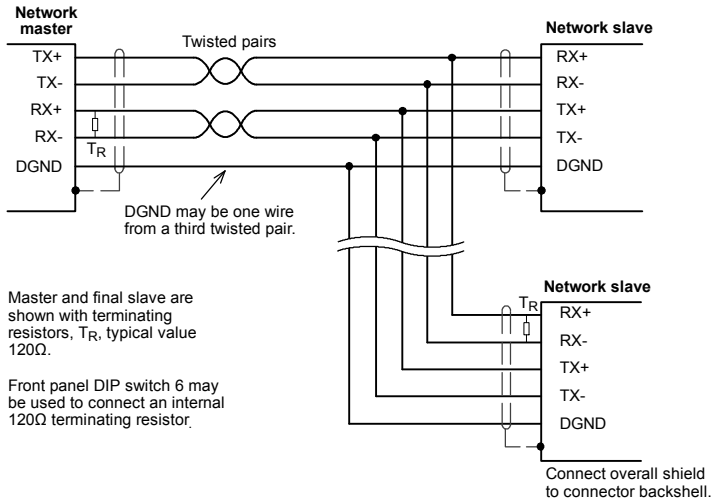
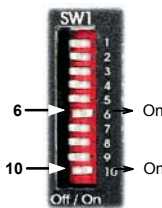

Figure 40 - 4-wire RS422 multi-drop connections



Any FlexDrive^{II} on the network must have its SW1 DIP switch 10 (located on the front panel) set to the On position (see also section 3.9.7). This will set the serial port to RS422/RS485 mode after the next power off/on cycle. When SW1 DIP switch 6 is set to the On position, a 120Ω termination resistor is connected between the RX+ and RX- signals.

Each TX/RX network requires a termination resistor at the final RX connection, but intermediate devices must not be fitted with termination resistors. An exception is where repeaters are being used which may correctly contain termination resistors. Termination resistors are used to match the impedance of the load to the impedance of the transmission line (cable) being used. Unmatched impedance causes the transmitted signal to not be fully absorbed by the load. This causes a portion of the signal to be reflected back into the transmission line as noise. If the source impedance, transmission line impedance, and load impedance are all equal, the reflections (noise) are eliminated. Termination resistors increase the load current and sometimes change the bias requirements and increase the complexity of the system.

4.4.6 Connecting Baldor HMI Operator Panels

Baldor HMI Operator Panels use a 15-pin male D-type connector (marked PLC PORT), but the FlexDrive^{II} connector X6 is a 9-pin male D-type connector. If you do not require hardware handshaking then use the connections shown in Figure 41:

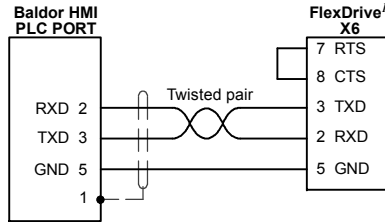

Figure 41 - Cable wiring if hardware handshaking is *not* required

If hardware handshaking is required then use the connections shown in Figure 42:

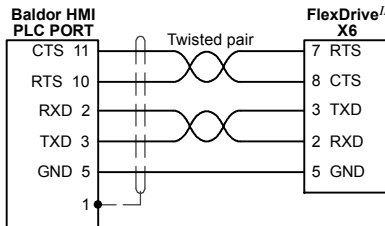
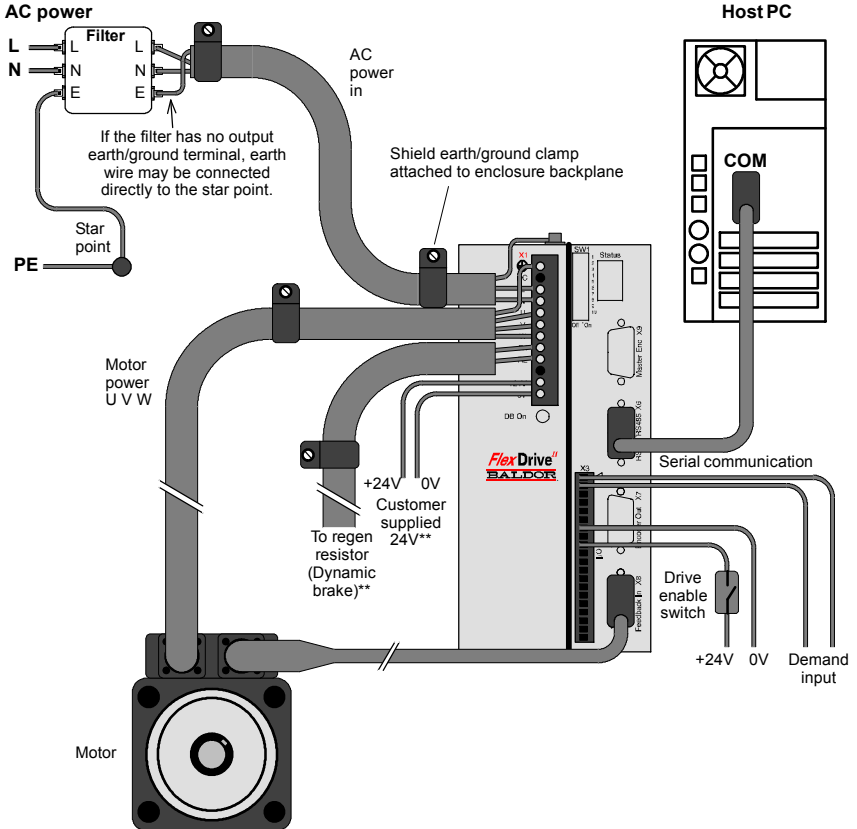

Figure 42 - Cable wiring if hardware handshaking *is* required

4.5 Connection summary - minimum system wiring

As a guide, Figure 43 shows an example of the typical minimum wiring required to allow the FlexDrive^{II} to control a motor.



** Model shown: FDH2A07TR-RN23:

This model requires an external regeneration resistor and customer supplied 24V supply - see sections 3.6 and 3.4.7. Some models contain an internal 24V supply and/or an internal regeneration resistor.

Demand input may be differential or single ended. See section 4.2.1.

The encoder output (X7) would normally be connected to a motion controller (not shown).

Motor represents a typical Baldor BSM motor. Linear motors may also be controlled by FlexDrive^{II}.

Shield earth/ground clamps are not supplied.

Figure 43 - Example minimum system wiring

4.6 Option connectors

If there are additional connectors on the front panel of your FlexDrive^{II} that have not been described in previous sections, these are part of a factory fitted option. You will need to refer to the extra manual supplied with your FlexDrive^{II} for details of the option's connectors.

5.1 Introduction

Before powering the FlexDrive^{II} you will need to connect it to the PC using a serial cable and install the supplied PC software *Mint WorkBench*. This software includes a number of tools to allow you to configure and tune the FlexDrive^{II}. If you do not have experience of software installation or Windows applications you may need further assistance for this stage of the installation.

5.1.1 Connecting the FlexDrive^{II} to the PC

Connect the serial cable between a PC serial port (often labeled as "COM") to the FlexDrive^{II} connector X6 (RS232/RS485). Mint WorkBench can scan all the COM ports, so you can use any port.



CAUTION: The serial connector on the FlexDrive^{II} (X6) can be configured as either RS232 or RS485 / RS422. If this is the first time you are installing a FlexDrive^{II} then it is strongly recommended that you use RS232 to get started (the preset factory setting) and use RS485 later. Pin 9 is used to carry +8V for powering a Baldor keypad peripheral. Ensure that pin 9 is not connected to earth/ground or to equipment that could be damaged by the +8V supply. A suitable cable is available from Baldor, catalog number CBL001-501.

5.1.2 Installing the software

The CDROM containing the software can be found separately within the packaging.

1. Insert the CDROM into the drive.
2. After a few seconds the setup wizard should start automatically. If the setup wizard does not appear, select Run... from the Windows Start menu and type

d:\start

where **d** represents the drive letter of the CDROM device (use the correct letter for your installation).

Follow the on-screen instructions to install Mint WorkBench. The setup wizard will copy the files to appropriate folders within the C:\Program Files folder, and place shortcuts on the Windows Start menu.

5.1.3 Starting the FlexDrive^{II}

If you have followed the instructions in the previous sections, you should now have connected all the power sources, your choice of inputs and outputs and the serial cable linking the PC with the FlexDrive^{II}.

5.1.4 Preliminary checks

Before you apply power for the first time, it is very important to verify the following:

- Disconnect the load from the motor until instructed to apply a load. If this cannot be done, disconnect the motor wires at connector X1/X1A.
- Verify that the front panel DIP switches 1-9 are in the Off position. It is recommended that you use RS232 communications to begin with, in which case DIP switch 10 must also be in the Off position. However, if you are using RS485/RS422 communication then DIP switch 10 must be in the On position (also DIP switch 6 if termination is required).
- Verify that the AC line voltage matches the specification of the FlexDrive^{II}.
- Inspect all power connections for accuracy, workmanship and tightness.
- Verify that all wiring conforms to applicable codes.
- Verify that the FlexDrive^{II} and motor are properly earthed/grounded.
- Check all signal wiring for accuracy.

5.1.5 Power on checks

If at any time the Status display shows a flashing symbol or 'E.' this indicates that the drive has detected a fault - see section 7.

1. Turn on the 24VDC supply (only for FlexDrive^{II} with catalog numbers FDHxxxx-xxx3 / FPHxxxx-xxx3).
2. Turn on the AC supply.
3. After a brief test sequence, the Status display should show a minus sign (-).

If the display is not lit then re-check the power supply connections.

4. If the motor wires were disconnected in section 5.1.4, turn off the AC supply and reconnect the motor wires. Turn on the AC supply.
5. To allow the Commissioning Wizard to function, SW1 DIP switch 8 will need to be set to the On position to allow the FlexDrive^{II} to be enabled. If you do not wish to enable the FlexDrive^{II} yet, the Commissioning Wizard will inform you when this step is necessary.
6. To allow the Commissioning Wizard to function, the +24VDC drive enable signal will need to be present on connector X3 (between pins 7 and 9) to allow the FlexDrive^{II} to be enabled. If you do not wish to enable the FlexDrive^{II} yet, the Commissioning Wizard will inform you when this step is necessary.

The FlexDrive^{II} is now ready to be commissioned using Mint WorkBench.

5.1.6 Offset tuning

If the FlexDrive^{II} will be using analog input 0 (AIN0) as a demand reference input (or for any other purpose) you may wish to perform offset tuning before continuing. The purpose of offset tuning is to remove DC offset voltages on the demand reference input to achieve a stationary motor shaft with 0VDC at the input. Offset tuning is controlled by DIP switches 7 and 8.

Before starting, confirm that the device supplying the AIN0 demand input is set to its intended zero output setting (nominally 0VDC).

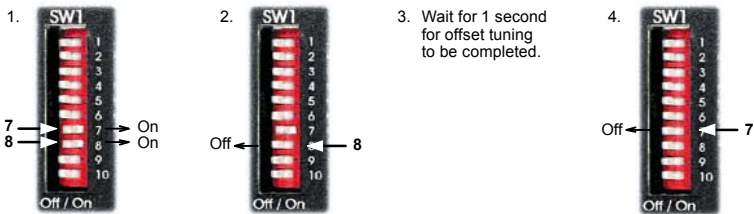



Figure 44 - Offset tuning using switch 7 and 8

After offset tuning, remember to set switch 8 to the On position to allow the drive to be enabled.

5.2 Mint WorkBench

Mint WorkBench is a fully featured application for programming (Flex+Drive^{II} only) and controlling the FlexDrive^{II}. The main Mint WorkBench window contains a menu system, the Toolbox and other toolbars. Many functions can be accessed from the menu or by clicking a button - use whichever you prefer. Most buttons include a 'tool-tip'; hold the mouse pointer over the button (don't click) and its description will appear.

5.2.1 Help file

Mint WorkBench includes a comprehensive help file that contains information about every Mint keyword, how to use Mint WorkBench and background information on motion control topics. The help file can be displayed at any time by pressing F1. On the left of the help window, the Contents tab shows the tree structure of the help file. Each book  contains a number of topics . The Index tab provides an alphabetic list of all topics in the file, and allows you to search for them by name. The Search tab allows you to search for words or phrases appearing anywhere in the help file. Many words and phrases are underlined and highlighted with a color (normally blue) to show that they are links. Just click on the link to go to an associated keyword. Most keyword topics begin with a list of relevant See Also links.

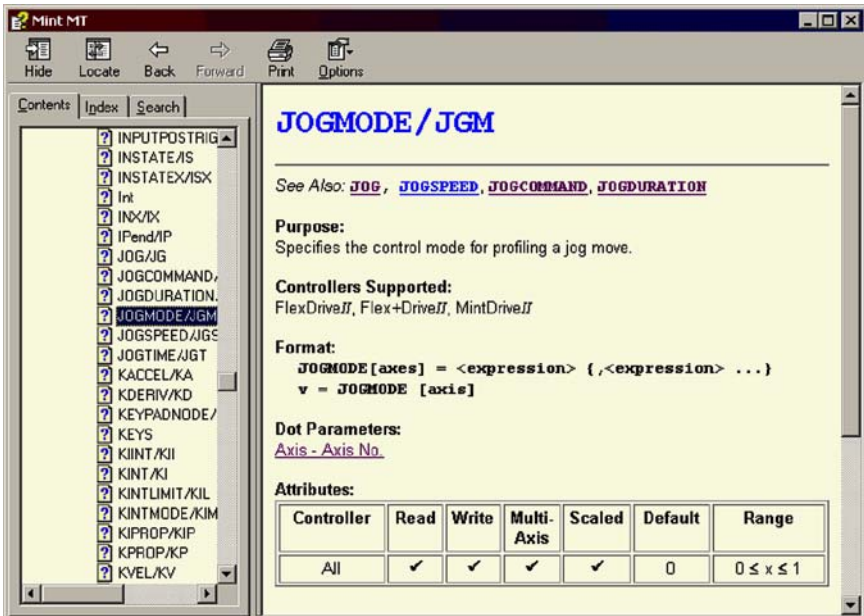



Figure 45 - The Mint WorkBench help file

For help on using Mint WorkBench, click the **Contents** tab, then click the small plus sign  beside the **Mint WorkBench** book icon. Double click a  topic name to display it.

5.2.2 Starting Mint WorkBench

1. On the Windows Start menu, select Programs, Mint Machine Center, Mint WorkBench.

Mint WorkBench will start, and the Tip of the Day dialog will be displayed.

You can prevent the Tip of the Day dialog appearing next time by removing the check mark next to Show tips at startup.

Click **Close** to continue.

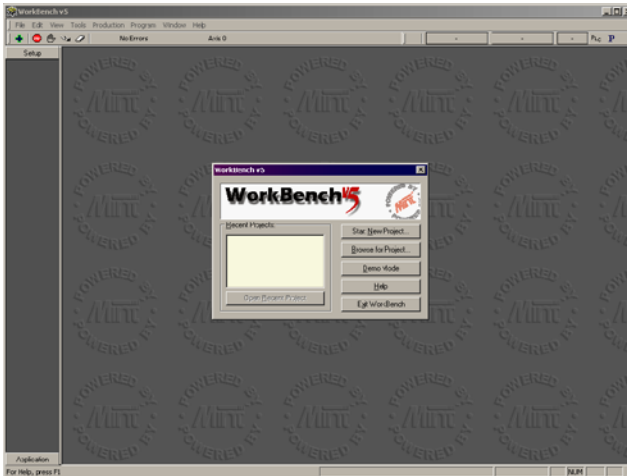

2. In the opening dialog box, click **Start New Project...**



- In the Select Controller dialog, go to the drop down box near the top and select the PC serial port to which the drive is connected.

(If you are unsure which PC serial port is connected to the drive, select **Scan all serial ports**).

Click **Scan** to search for the FlexDrive^{II}.

When the search is complete, click on FlexDrive^{II} in the list to select it, and click the **Select** button.

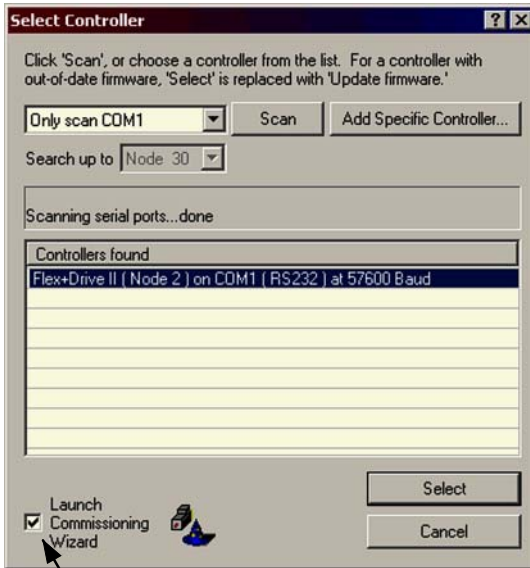

This check box is already selected for you. When you click **Select**, it means that the Commissioning Wizard will start automatically.

Note: If the FlexDrive^{II} is not listed, check the serial lead between the FlexDrive^{II} and the PC and that the FlexDrive^{II} is powered correctly. Click **Scan** to re-scan the ports.

5.2.3 Commissioning Wizard

Each type of motor and drive combination has slightly different performance characteristics. Before the FlexDrive^{II} can be used to control the motor accurately, the FlexDrive^{II} must be “tuned”. This is the process where the FlexDrive^{II} powers the motor in a series of tests. By monitoring the feedback from the motor’s resolver or encoder and performing a number of calculations, the FlexDrive^{II} can make small adjustments to the way it controls the motor. This information is stored in the FlexDrive^{II} EEPROM and can be uploaded to a file if necessary. The Commissioning Wizard provides a simple way to tune the FlexDrive^{II} and create the necessary configuration information for your drive/motor combination, so this is the first tool that should be used.

5.2.4 Using the Commissioning Wizard



CAUTION: The motor will move during commissioning. For safety it is advisable to disconnect any load from the motor during initial commissioning. The motor can be tuned with the load connected after the Commissioning Wizard has finished.

Each screen of the Commissioning Wizard requires you to enter information about the motor or drive. Read each screen carefully and enter the required information.

If you need extra help, click the **Help** button or press F1 to display the help file.

When you have completed a screen, click **Next >** to display the next screen. If you need to change something on a previous screen, click the **< Back** button. The Commissioning Wizard remembers information that you have entered so you will not need to re-enter everything if you go back to previous screens.

5.2.5 Completing the Commissioning Wizard

The final screen (Tuning) has a Finish button that is grayed out until the tuning tests have been completed. When the tuning tests have finished click **Finish** to complete the Commissioning Wizard.

The parameters that have been calculated by the Commissioning Wizard do not need to be downloaded to the FlexDrive^{II}. They are already in the FlexDrive^{II} and will not be lost even when it is powered down.

5.2.6 Performing a test move

This section tests the basic operation of the drive and motor.

1. Check that the Drive enable button is pressed (down).



2. In the Toolbox, click the Edit & Debug icon.



3. Click in the Command window.

4. Type:
JOG.0 = 10

This will cause the motor to move continuously at 10 units per second. In Mint WorkBench, look at the Spy window located on the right of the screen. The Spy window's Velocity display should show 10 (approximately). If there seems to be very little motor movement, it is probably due to the scale factor.

In the Commissioning Wizard, on the Position Control page, if you did *not* adjust the scale factor then the current unit of movement is feedback counts per second. Depending on the motor's feedback device, 10 feedback counts per second could equate to a very small velocity. Issue another JOG command using a larger value, or use the Operating Mode Wizard to select a suitable scale factor (e.g. 4000 if the motor has a 1000 line encoder, or 10,000 for a 2500 line encoder).

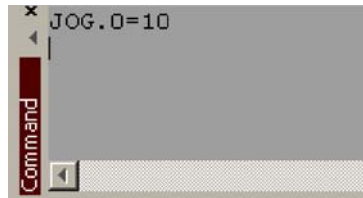

5. To stop the test, type:
STOP.0

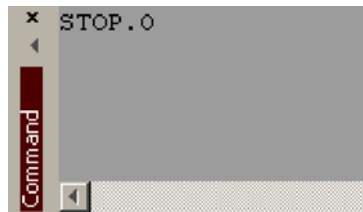

5.3 Further configuration

Mint WorkBench provides a number of tools, each of which has an icon on the left of the screen. Click once on an icon to select the tool. Three of the main tools used for tuning and configuring the FlexDrive^{II} are described in the following sections.

Every tool is explained fully in the help file. Press F1 to display the help file, then navigate to the Mint WorkBench book. Inside this is the Toolbox book.

5.3.1 Fine-tuning tool

The Commissioning Wizard calculates many parameters that allow the FlexDrive^{II} to provide basic control of the motor. These parameters may need to be fine-tuned to provide the exact response that you require. The Fine-tuning screen allows you to do this.

1. Click the Fine-tuning icon in the Toolbox on the left of the screen.

The Fine-tuning window is displayed at the right of the screen. This already shows some of the parameters that have been calculated by the Commissioning Wizard.



The main area of the Mint WorkBench window displays the capture window. When further tuning tests are performed, this will display a graph representing the response.

2. The Fine-tuning window has three tabs at the bottom - Position, Speed and Current. Click on a tab to select it.

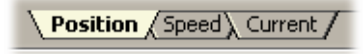

Click the tab for the type of tests you wish to perform.

Note: Some tabs may not be available depending on the configuration mode you selected in the Commissioning Wizard.

5.3.1.1 Fine-tuning - Position tab

The position tab allows you to set position loop gains and perform test moves. The Commissioning Wizard may have already set some of these values, depending on the type of system selected on the mode screen.

Enter new values in the required boxes and then click **Apply** to download the values to the FlexDrive^{II}. To perform tests, go to the Test Parameters area at the bottom of the tab. Enter test values and then click **Go** to perform the test move. If you need help, just press F1 to display the help file.

5.3.1.2 Fine-tuning - Speed tab

The speed tab allows you to set speed loop gains and perform test moves. The Commissioning Wizard may have already set some of these values, depending on the type of system selected on the mode screen.

Enter new values in the required boxes and then click **Apply** to download the values to the FlexDrive^{II}. To perform tests, go to the Test Parameters area at the bottom of the tab. Enter test values and then click **Go** to perform the test move. If you need help, just press F1 to display the help file.

5.3.1.3 Fine-tuning - Current tab

The current tab allows you to set current loop gains and perform test moves. The Commissioning Wizard may have already set some of these values, depending on the type of system selected on the mode screen.

Enter new values in the required boxes and then click **Apply** to download the values to the FlexDrive^{II}. To perform tests, go to the Test Parameters area at the bottom of the tab. Enter test values and then click **Go** to perform the test move. If you need help, just press F1 to display the help file.

The additional **Measure** and **Feedback alignment** buttons can be used to repeat the same measurement and alignment tests as the Commissioning Wizard.

5.3.2 Parameters tool

The Parameters tool can be used to setup many important parameters, such as a scaling factor for the feedback input, and the action to take when errors occur.

1. Click the Parameters icon in the Toolbox on the left of the screen.

The main area of the Mint WorkBench window displays the Controller Parameters screen.



2. The Controller Parameters screen has a number of tabs listed on the left. Click on a tab to select it.

If you need help with any of the options, just press F1 to display the help file.

Remember to click the tab's **Apply** button to send the changes to the FlexDrive^{LL}.

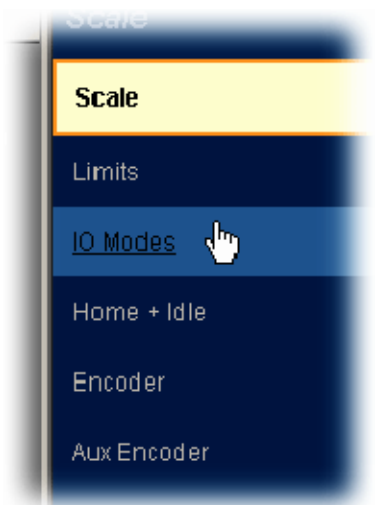

5.3.3 Digital I/O tool

The Digital I/O tool allows you to define how each digital input and output will be triggered and if it is to be assigned to a special function, for example the forward limit or stop input.

1. Click the Digital I/O icon in the Toolbox on the left of the screen.

The main area of the Mint WorkBench window displays the Digital I/O screen. You can use a drag and drop method to assign triggering options to inputs and outputs and assign them to special purpose functions.

Remember to click the **Apply** button to send the changes to the FlexDrive^{II}. If you need help, just press F1 to display the help file.



5.3.4 Other tools and windows

Each tool and window is explained fully in the help file, so is not described here in detail.

- **Edit & Debug Tool**
This tool provides a work area including the Command window and Output window. The Command window can be used to send immediate Mint commands to both the FlexDrive^{II} and Flex+Drive^{II}.
- **Scope Tool**
Displays the capture screen. This screen is also shown when the Fine-tuning tool is selected.
- **Jog Tool**
Allows you to perform jog moves - useful for testing purposes.
- **PLC Task Tool**
Allows you to setup the PLC Task, a special task that can be used to check for a number of pre-defined conditions and then perform actions if they become true.
- **Error Log Tool**
Displays a list showing when errors occurred and when they were cleared.
- **Spy window**
Allows you to monitor all the important parameters for the axis, and shows the state of digital inputs and outputs, limit switches and comms locations.

Flex+Drive^{II} only:

- **Edit & Debug** also provides the environment for programming the Flex+Drive^{II}. Multiple editing windows can be opened for entering program code.
- **Presets Tool**
Allows you to setup preset moves and the way in which they should be triggered. An interactive table of the moves is used to make changes.
- **Homing Tool**
Allows you to setup homing moves.

Remember, for help on each tool just press F1 to display the help file, then navigate to the Mint WorkBench book. Inside this is the Toolbox book.

6.1 Introduction

Two of the important features introduced on the FlexDrive// are preset moves and the PLC task. Basic operation of these two features are described in the following sections.

6.2 Preset moves

The FlexDrive^{II} can store 16 preset moves. (**Flex+Drive^{II} only:** If the CAN & Auxiliary I/O option is fitted, 256 preset moves can be stored.) Presets can be selected and triggered using software (Mint WorkBench or a Mint program) or by using a combination of the digital inputs.

In Mint WorkBench, the Presets tool displays an interactive table allowing you to set up the preset moves. Mint WorkBench reads the current preset data from the FlexDrive^{II} whenever you switch to the Presets tool. Preset tables can be saved in files on the PC and downloaded to the FlexDrive^{II} from Mint WorkBench.

For the following explanation, the FlexDrive^{II} must be connected, powered and ready to be enabled. The FlexDrive^{II} must also be in Position Control Mode, which can be selected using the Operating Mode Wizard in Mint WorkBench.

6.2.1 Defining a preset move

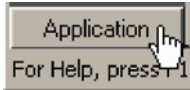
1. In the Mint WorkBench Toolbox, click **Application** then click the Presets icon. Existing presets will be read from the FlexDrive^{II} and displayed in the presets table.
- 
2. Each preset is shown on a separate row in the table. To define (or edit) a preset, click one of the preset numbers in the Index column.
 3. On the selected row, click in the Type column. The drop-down box allows you to select the jog move type. (**Flex+Drive^{II} only:** an absolute / relative positional move, homing move, or set position may also be selected). The Value column will change accordingly.
 4. Click in the Value column to set the appropriate value. Any values entered in the preset table to specify a position, slew speed, acceleration, or deceleration are interpreted as user units.
 - For a jog move, the value represents the direction in which the axis will jog.



Flex+Drive^{II} only:

- For an absolute move, the value represents the absolute position to which the axis will move when the preset is used.
 - For a relative move, the value represents the amount by which the axis will move relative to its existing position when the preset is used.
 - For a set position, the value represents the new axis position that will be set when the preset is used. No movement will occur.
 - For a homing move, the Homing settings window is displayed. Choose the required settings for the homing move and click **OK**. The value column will display the corresponding value of the HOME keyword for the chosen settings. Press F1 to display the Mint help file for details of the HOME keyword.
5. Click in the Slew speed, Acceleration and Deceleration boxes to set appropriate values for the move profile.
 6. Click **Apply** to download the presets table to the FlexDrive^{II}.

6.2.2 Testing a preset move

For testing, Mint WorkBench can be used to trigger the preset moves.

1. At the bottom of the Presets window, ensure that the Software option is checked. This means that Mint WorkBench will be used to control the preset moves.
2. If the drive is not already enabled, click the drive enable  icon on the toolbar.

Just above the Presets table, click **Enable** to allow preset moves.

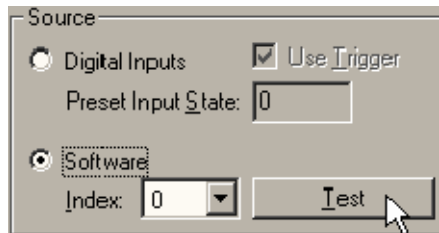

3. In the Index drop down box, select a preset number to test and click **Test**. The preset move will now be performed.

Note: The  button on the mode toolbar can also be used to enable or disable preset moves, even if the Presets tool is not currently selected.

6.2.3 Using digital inputs to trigger a preset move

In normal operation preset moves can be selected and triggered by external equipment, using a combination of the digital inputs.

1. At the bottom of the Presets window, ensure that the Digital Inputs option is checked. This means the digital inputs will be used to control the preset index. Click **Apply** to send the changes to the FlexDrive^{II}.

The Use Trigger option should also be checked. This means that a digital input will be used to trigger the preset move.

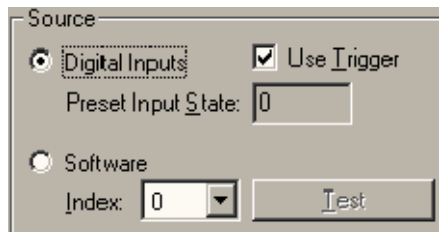

Note: If the Use Trigger input is not checked, preset moves will be triggered instantly on changing to the selected preset index. This mode should be used with care, as the change of state of digital inputs may not be synchronized. The Trigger pulse must have a duration of at least 2ms to ensure that it is recognized by the drive.

6.2.3.1 Configuring digital inputs to control presets

The default combination of digital inputs used for triggering presets is 6, 7, 0 and 1 to select the preset, and 5 to trigger the preset. However, this combination can be changed to use any four (or fewer) contiguous inputs, plus a trigger input. The inputs form a bit pattern that represents the preset to be selected. Consequently, if the application requires only a small number of different preset moves, you can reduce the number of inputs required to select the preset.

The following table shows the combinations of digital inputs that must be active to trigger each preset index move. The table shows 4 inputs being used (0 - 3), allowing 16 presets to be selected:

Preset index (Bit pattern sum)	Digital input 0 (Bit pattern value: 1)	Digital input 1 (Bit pattern value: 2)	Digital input 2 (Bit pattern value: 4)	Digital input 3 (Bit pattern value: 8)
0	0	0	0	0
1	1	0	0	0
2	0	1	0	0
3	1	1	0	0
4	0	0	1	0
5	1	0	1	0
6	0	1	1	0
7	1	1	1	0
8	0	0	0	1
9	1	0	0	1
10	0	1	0	1
11	1	1	0	1
12	0	0	1	1
13	1	0	1	1
14	0	1	1	1
15	1	1	1	1

Table 3 - Preset selection using digital inputs 0-3

For example, to select preset move 6, digital inputs 1 and 2 must be active. The choice of digital inputs is configured using the Digital I/O tool:

1. In the Toolbox, click **Setup** then click the Digital I/O icon.

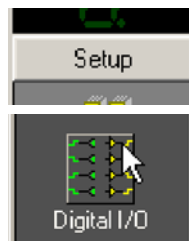

- At the bottom of the Digital I/O window, click in the Preset Inputs drop down box and select the number of inputs to be used for preset selection.



For example, if the application requires only four different preset moves, choose 2. This means only two digital inputs will be used to select preset moves, allowing 4 different combinations (moves) to be selected. Similarly, to allow selection of up to 8 different preset moves choose 3; for up to 16 different moves choose 4. Selecting fewer digital inputs will leave more free for other purposes.

- If the default inputs shown by the Preset Sel icon are not suitable, drag a different IN icon onto the Preset Sel icon. This will set the lowest numbered input used for preset selection, with the other required inputs selected automatically. It is not possible to select a discontinuous range of inputs for preset selection, although the trigger input may be any input.

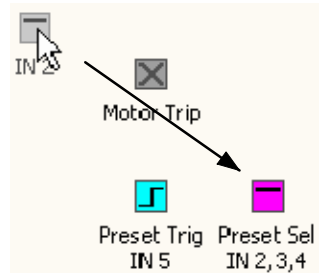

- If the default input shown by the Preset Trig icon (the trigger input) is not suitable, drag a different IN icon onto the Preset Trig icon.

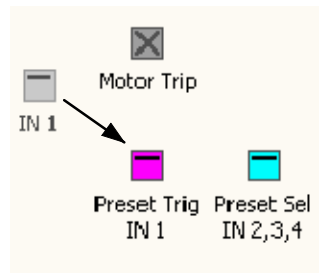

- Click **Apply** to send the changes to the FlexDrive^{II}.



When you return to the Presets tool, the presets table (and the Addressable Presets box) will show the number of presets that can be selected by the chosen number of inputs.

Presets will now be selected and triggered when the appropriate digital inputs are active.

6.2.4 Controlling preset moves

Additional options are available to control the operation of preset moves.

Dwell Time can be used to set a delay period between the triggering of a preset move and its commencement.

If the Wait for Idle option is checked, the preset move will not begin until the previous one has been completed. If it is *not* checked, the new move will be started immediately. To allow this, the profile of the current move will be modified to smoothly adjust to the new move's profile.

Learn Current Position

Addressable Presets: 8

Current Active Preset Index: -1

Dwell Time: 0 ms

Wait for Idle

Flex+Drive^{II} only:

The Learn Current Position button can be used to read the current position and assign it to the Value / Position column for the currently selected preset. This function can only be used for Absolute moves; if the preset type is not already set to Absolute, it will be set automatically.

The configuration and operation of preset moves can also be controlled by a Mint program, using a range of keywords beginning with PRESET See the Mint help file for details.

6.2.5 Using presets with the CAN & Auxiliary I/O option

Flex+Drive^{II} only:

If the CAN & Auxiliary I/O option is fitted (Option B) the additional digital inputs allow up to 256 presets to be selected.

The Extended tab below the presets table displays the preset table for presets 16 to 255. The Extended tab only appears if the CAN & Auxiliary I/O option is fitted.

Extended presets can only be used for Relative or Absolute moves, and they do not have unique Slew speed, Acceleration or Deceleration parameters. The extended presets are divided into groups of 16 presets (16-31, 32-47, 48-63 etc.), selected using the Group box. Each *group* of presets has unique parameters, set using the Slew Speed, Acceleration and Deceleration boxes.



In the Digital I/O tool, the number of inputs that may be selected in the Preset Inputs box also increases to 8, to allow up to 256 presets to be selected.

6.3 PLC Task

The PLC Task is a special task that can be set up to monitor various events and act upon them if they become true. In Mint WorkBench, the PLC Task tool allows you to enter conditional statements that respond to the events by performing a particular action. The statements can be downloaded to the FlexDrive^{II} if required. Mint WorkBench reads the current state of the PLC Task table (from the FlexDrive^{II}) whenever you switch to PLC Task mode. For the following explanation, the FlexDrive^{II} must be connected and powered.

6.3.1 Defining conditions

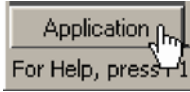
Each action is triggered as a result of the logical evaluation of one or two conditions, called Condition 1 and Condition 2. If the result of this logical comparison is true, the action is triggered. Condition 2 does not need to be defined if it is not required.

1. In the Mint WorkBench Toolbox, click **Application** then click the PLC Task icon. Existing actions will be read from the FlexDrive^{II} and displayed in the PLC Task table. Each action is shown on a separate row in the table.
 
2. Choose a row and click in the IF Condition 1 column. The word False will change into a drop down box.
 
3. Select a condition by clicking on its name in the list. For example, selecting Digital input will mean that a digital input will be monitored to check if it is active. A full description of each Condition is provided in the `PLCCONDITION` topic of the Mint help file.
4. Click in the adjacent Ch column and choose the related channel (if required). For example, if Digital input was selected, choose *which* digital input will be monitored.

6.3.1.1 Configuring Condition 2 (optional)

The Operator and Condition 2 columns need to be changed only if you want the action to depend on the logical evaluation of two conditions (Condition 1 and Condition 2). By leaving the Operator column set to OR, and the Condition 2 column set to False, the state of Condition 1 will be used to trigger the action. If you do not wish to configure the second condition, go to section 6.3.2.

5. Click in the Operator column. The word OR will change into a drop down box. Select a logical operator from the list. This operator will be used to evaluate the two conditions. If the result of the logical evaluation is true, the action will be performed.
6. Click in the Condition 2 column. The word False will change into a drop down box. Select a condition by clicking on its name in the list.
7. If necessary, click in the second Ch column and select the required channel.

6.3.1.2 Choosing the action to be performed

8. Click in the THEN Action column and choose the action that will performed when the conditions become true.
9. If necessary, click in the final Ch column and select the required channel.

6.3.2 Enabling and downloading the actions

Individual actions can be enabled by clicking in the appropriate check box in the Enable column. When the PLC Task is activated, only those actions that have been enabled will be evaluated.

1. Set the required check boxes in the Enable column.

Enable	IF Condition 1	Ch
<input checked="" type="checkbox"/>	0 Digital Input	Chn. 3
<input type="checkbox"/>	1 Hardware Limit Fwd	Axis 0
<input checked="" type="checkbox"/>	2 On Idle	Axis 0
<input type="checkbox"/>	3 False	-
<input type="checkbox"/>	4 False	-

Now that you have configured and enabled all the conditions you require, they must be downloaded to the FlexDrive^{II}.

2. Click **Apply** to download the conditions.

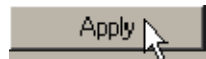

The **Enable** button above the table must be in the on (down) position to activate the PLC Task. When the PLC Task is not in use it should be switched off to reduce processing power.

3. To activate the PLC Task, click **Enable** at the top of the screen.



Note: The  button on the mode toolbar can also be used to enable or disable PLC Task, even if the PLC Task tool is not currently selected.

The controller will now monitor all the conditions for the enabled actions. If the logical result of any set of conditions becomes true, the corresponding action will be performed. An individual action can be disabled even while the PLC Task is running. To disable an action that is not required, clear the action's enable check box and click **Apply**. Remember to disable the PLC Task when it is not required, to reduce processing power.

6.3.2.1 Other functions

If the Auto-Enable PLC Task box is checked, the PLC Task will be enabled automatically every time the drive is reset. This option corresponds to the keyword `PLCAUTOENABLE`; see the Mint help file for details.

The value in the PLC Time box defines how often the PLC Task is run. This may be set (in 5ms intervals) to a maximum value of 1 second (1000ms). If the evaluation of the PLC Task is not critical in your application, it is advisable to set PLC Time to a large value. This will reduce the overall processing time taken by the PLC Task.

The Gear Factor defines the gear factor used by the Fast Gear action; see the Mint help file topic `PLCGEARFACTOR` for details.

The Jog Speed box can be used to enter a jog speed, expressed in user units. This value is used by the Jog positive and Jog negative actions. The value in this box is linked to the Velocity slider shown in Jog mode.

The Clear and Default buttons can be used to either clear or default all conditions.

6.3.3 Testing the PLC Task

There is no way to test the PLC Task other than causing the required conditions to occur. For example, if you have an action that is triggered by the condition Digital input 0, then activating digital input 0 will cause the corresponding action to occur.

6.4 Saving presets or PLC conditions

Preset tables and PLC conditions can be saved separately on the PC for later recall. For this purpose, Presets mode and PLC Task mode have Open, Save and Help icons just above their tables.

1. Click the Save icon just above the table.
2. In the Save As dialog, enter a filename.

Preset tables are saved with a .pre file extension.
PLC Task tables are saved with a .plc file extension.

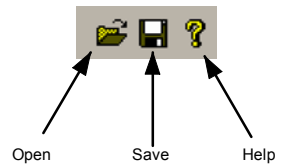

To open a file, click the open icon select the file and click **Open**. When the table has loaded, remember to click **Apply** to download the table to the FlexDrive^{II}.

7.1 Introduction

This section explains common problems that may be encountered, together with possible solutions.

7.1.1 Problem diagnosis

If you have followed all the instructions in this manual in sequence, you should have few problems installing the FlexDrive^{II}. If you do have a problem, read this section first. In Mint WorkBench, use the Error Log tool to view recent errors and then check the help file. If you cannot solve the problem or the problem persists, the SupportMe feature can be used.

7.1.2 SupportMe feature

The SupportMe feature (on the Help menu) can be used to e-mail information to the Baldor representative from whom you purchased the equipment. If required, you can choose to add your program files as attachments. Mint WorkBench will automatically start up your e-mail program and begin a new message, with comprehensive system information and selected attachments already in place. You can add any additional message of your own and then send the e-mail. The PC must have email facilities to use the SupportMe feature. If you prefer to contact Baldor technical support by telephone or fax, contact details are provided at the front of this manual. Please have the following information ready:

- The serial number of your FlexDrive^{II}.
- Use the Help, SupportMe menu item in Mint WorkBench to view details about your system.
- The catalog and specification numbers of the motor that you are using.
- Give a clear description of what you are trying to do, for example trying to establish communications with Mint WorkBench or trying to perform fine-tuning.
- Give a clear description of the symptoms that you can observe, for example the Status display, error messages displayed in Mint WorkBench, or the current value of any of the Mint error keywords AXISERROR, AXISSTATUS, INITERROR, MISCERROR and DRIVEERROR.
- The type of motion generated in the motor shaft.
- Give a list of any parameters that you have setup, for example the motor data you entered/selected in the Commissioning Wizard, the gain settings generated during the tuning process and any gain settings you have entered yourself.

7.1.3 Power-cycling the FlexDrive^{II}

The term "Power-cycle the FlexDrive^{II}" is used in the Troubleshooting sections. On models with a customer supplied 24V supply, remove the 24V supply, wait for the FlexDrive^{II} to power down completely (all Status LED segments will turn off), then re-apply the 24V supply. On models with an internally generated 24V supply, remove the AC power supply, wait for the FlexDrive^{II} to power down completely (all Status LED segments will turn off), then re-apply AC power.

7.2 FlexDrive^{II} indicators















7.2.1 Status display



The Status LED display indicates general FlexDrive^{II} status information. Some characters will flash to indicate an error.

0.	Drive / comms watchdog. Interprocessor communications failure. This is potentially a severe problem if it occurs repeatedly. Communications failure could indicate a process locking out the interprocessor communications. Clear the error; if the problem persists then contact Baldor technical support.
1.	Over volts. The DC Bus voltage has exceeded the powerbase overvolts level (see DRIVEBUSOVERVOLTS). Check the DC Bus level being fed into the system (see Mint keyword DRIVEBUSVOLTS). This should be close to the nominal voltage (see Mint keyword DRIVEBUSNOMINALVOLTS). Ensure that your input voltage is relevant to the voltage rating of your drive. If the input voltage is correct, then this error may be the result of high deceleration rates. If it is not possible to reduce the harshness of the deceleration rate, then a regeneration resistor should be used. To help you, use Mint WorkBench capture facility to monitor the DC Bus level during moves.
2.	Integrated Power Module (IPM) trip. The unit's powerbase has been overloaded. This should not happen in normal use if limits have been configured correctly. See the Mint keyword CURRENTLIMIT and related commands.
3.	Current trip. Instantaneous over-current trip. One or more of the 3 motor phases has exceeded 300% of Drive Rated Current.
4.	Under volts. The DC Bus voltage has dropped below the powerbase undervolts level (see DRIVEBUSUNDERVOLTS). This error will only be generated if the drive is in the enabled state. As with the overvolts error, check the input voltage being fed into the system. The error could also occur during high acceleration profiles.
5.	Feedback trip. Can be enabled/disabled using FEEDBACKFAULTENABLE. Five consecutive errors (or five errors in any 500 servo tick period) will cause the drive to trip. This error indicates loss of encoder/resolver feedback and may indicate that the feedback cable has become detached or one of the signals has broken. Check the wiring in the Feedback cable; check for noise immunity; check the feedback device fitted to the motor (if possible).
6.	Motor or Drive trip. The motor I ² T or the drive I.T current protection algorithms have exceeded their limit and tripped the drive (disabled it). Check DRIVEERROR or the Error Log to determine which error has occurred. The motor and drive current limits are fixed according to the database parameters. The drive can demand peak current for a short duration (see DRIVEPEAKDURATION), thereafter it will trip or Foldback according to the setting of DRIVEOVERLOADMODE. The same is true for the motor (see MOTORPEAKDURATION and MOTOROVERLOADAREA). Use the Foldback option to automatically foldback the current to a level where the drive/motor can recover.
7	(Symbol not flashing) Motor I ² T / It foldback. Motor I ² T or Drive I.T algorithm has resulted in the demand current being folded back to a level where the drive/motor can recover. The motor / drive can run with demand currents greater than their rated value for a period of time; after that time the drive will either trip or automatically foldback the demand current.

7.	Overtemperature. The temperature of the drive or motor has exceeded a trip level (see Mint keyword <code>TEMPERATURELIMITFATAL</code>) or the Motor overtemperature trip input has been activated (see Mint keyword <code>MOTORTEMPERATUREINPUT</code>).
8	Drive enabled. The drive is enabled (except where <code>CONFIG = _cfVirtual</code> , where it is not physically enabled).
9	Torque mode. The drive is in Torque mode. See the Mint keywords <code>TORQUE</code> , <code>TORQUEREFSOURCE</code> and related commands.
A.	Auto tune test driving motor. Autotune is active and driving the motor. The motor may move.
b.	Power base not ready. This error condition applies to 3-phase drives only. These drives have a pre-charge circuit which must activate after power-up before the drive can be enabled. If the drive is enabled prior to this then the error occurs. The error could also indicate the loss of one or more of the input phases.
c	Cam. A Cam profile is being profiled. See the Mint keyword <code>CAM</code> .
E.	General error. See <code>AXISERROR</code> and <code>DRIVEERROR</code> . The motion toolbar displays the status of <code>AXISERROR</code> , which is a bit pattern of all latched errors. See also the <i>Error Log</i> topics in the help file.
e.	Error input. The <code>ERRORINPUT</code> has been activated and generated an error.
f	Flying shear. A flying shear is being profiled. See the Mint keyword <code>FLY</code> .
F.	Position or velocity following error. A following error has occurred. See the Mint keyword <code>AXISERROR</code> and associated keywords. Following errors could be caused by a badly tuned drive/motor. At higher acceleration and deceleration rates, the following error will typically be greater. Ensure that the drive/motor is adequately tuned to cope with these acceleration rates. The following error limit can be adjusted to suite your application (see Mint keywords <code>FOLERRORFATAL</code> and <code>VELFATAL</code>). Following error could also be the cause of encoder/resolver loss (see also Mint keyword <code>FEEDBACKFAULTENABLE</code>).
?	Follow mode. The drive is in Follow mode. See the Mint keyword <code>FOLLOW</code> .
H	Hold. The Hold DIP switch is active (see section 3.9.2) or the PLC Task has requested a Hold state. Motion will be ramped to zero demand and will then hold on position while the switch is active.
h	Homing. The drive is currently homing. See the Mint keyword <code>HOME</code> .
h.	Preset Homing. The drive is currently homing. This motion has been triggered from a Preset move table.
I	Incremental move. An incremental move is being profiled. See the Mint keywords <code>INCA</code> and <code>INCR</code> .
J	Jog. The drive is jogging. In the Mint help file, see the topics <code>JOG</code> , <code>JOGCOMMAND</code> and <i>Jog screen</i> .
J.	Preset jog. The drive is jogging. The jog was triggered from a Preset jog table.

	Overspeed. The measured speed of the motor has exceeded the trip level defined by DRIVESPEEDFATAL. Check that the trip level is set to a suitable value for your application. When accelerating to a demand speed close to the trip level, there will typically be a certain amount of overshoot. Using the Fine-tuning tool, check the amount of overshoot you get with the acceleration and demand speeds being used in your application.
	Positional Move. The drive is performing a linear move. See the Mint keywords MOVEA and MOVER.
	Preset positions. The drive is performing a linear move. This motion has been triggered from a Preset move table.
	DB Overload. The regeneration resistor (Dynamic Brake) has been overloaded. See the Mint keyword DBEXTTRIPSWITCH and associated keywords.
	Stop. A STOP command has been issued or the stop input is active.
	Drive disabled. The drive must be enabled before operation can continue. See section 3.8. Click the Drive enable button in Mint WorkBench.
	Crash. The drive enable input or the Enable DIP switch have become inactive whilst the drive was in the enable state (or the drive was enabled whilst they were inactive) - bit 13 in AXISERROR will be set. The drive can be programmed to ignore this state using the Mint keyword DRIVEENABLEINPUTMODE (see the Parameters tool).
	Suspend. The SUSPEND command has been issued and is active. Motion will be ramped to zero demand whilst active.
	Speed demand. The drive is under speed control. See the Mint keywords SPEEDREF, SPEEDREFSOURCE and related commands.
	Reverse software or hardware limit. A reverse limit has been activated. See AXISERROR and/or AXISSTATUS to determine which applies.
	Reverse software or hardware limit. A reverse limit has been activated, but no error has been generated. See AXISERROR and/or AXISSTATUS to determine which applies. This state can exist at the same time as a forward limit with no error, causing the resulting symbol to appear as H, the same symbol as Hold.
	Forward software or hardware limit. A forward limit has been activated. See AXISERROR and/or AXISSTATUS to determine which applies.
	Forward software or hardware limit. A forward limit has been activated, but no error has been generated. See AXISERROR and/or AXISSTATUS to determine which applies. This state can exist at the same time as a reverse limit with no error, causing the resulting symbol to appear as H, the same symbol as Hold.
	Firmware being updated (horizontal bars appear sequentially). New firmware is being downloaded to the drive.
	Initialization error. An initialization error has occurred at power on. See the <i>Error Log</i> or INITERROR topics in the help file. Initialization errors should not normally occur.

User defined symbols can be made to appear using the Mint keywords LED and LEDDISPLAY.

7.2.2 DB On (Regeneration) LED



The front panel **DB On** LED indicates regeneration activity.

Yellow	Power is being dissipated into the regeneration resistor
Off	No regeneration is occurring.

7.2.3 Communication

Problem	Check
Status display is blank	<p>Check that the customer supplied 24VDC power supply is connected correctly to connector X1 and is switched on.</p> <p>On models with an internally generated 24VDC supply, check that the AC power supply is connected correctly to connector X1 and is switched on.</p>
Mint WorkBench fails to detect the FlexDrive ^{II} - it detects "No controller found. Communication fault on COMx".	<p>Ensure that the FlexDrive^{II} is powered and the Status display is illuminated (see section 7.2).</p> <p>Check that the serial cable is connected between the PC's COM port and connector X6 on the FlexDrive^{II}.</p> <p>Check which PC COM port is being used, or use the "Scan all serial ports" option to locate the FlexDrive^{II}.</p> <p>Check the wiring of the serial cable or try an alternate cable. Check that DIP switch 10 (RS232/RS422) is set correctly (see section 3.9.7).</p> <p>On the PC, try an alternative COM port.</p> <p>Confirm that a mouse driver or other serial device is not conflicting (using the same COM port) as Mint WorkBench.</p> <p>Does the FlexDrive^{II} have firmware in it? If you tried to download new firmware and the download failed, the controller may not have firmware. If this has happened, the Status display will show a minus sign (-) and flash the decimal point repeatedly.</p> <p>Check that the selected Baud rate is supported by the PC and FlexDrive^{II}.</p> <p>If the "Only scan COMx" option is selected in Mint WorkBench, check that the correct COM port is selected.</p> <p>If the "Search up to Nodexx" option is selected in Mint WorkBench, check that the FlexDrive^{II} node number is not higher than this value.</p> <p>Do you have multiple nodes on the bus? If so, they must all be set to the same Baud rate. Mint WorkBench scans through all the node Id's at different Baud rates. When it finds a node, it will only continue to scan for other nodes at the same Baud rate.</p>

7.2.4 Power on

Problem	Check
The Status display is showing a flashing symbol with a static decimal point.	The FlexDrive ^{II} has detected a motion error. Use the Error Log tool to view a list of recent errors, or click the Error button on the motion toolbar to view a description of the error. Alternatively, type any or all of these commands in the Command window: PRINT AXISERROR PRINT DRIVEERROR PRINT MISCERROR PRINT INITERROR Click the Clear Errors button on the motion toolbar.

7.2.5 Tuning

Problem	Check
Cannot enable the FlexDrive ^{II} because <code>AXISERROR</code> has bit 13 set	Check the drive enable input on connector X3 pins 7 and 9 is connected and powered correctly. Check that DIP switch 8 (enable) is set to the On position.
When the FlexDrive ^{II} is enabled the motor is unstable	Check that the current loop has been tuned. Check that the current loop was tuned with the correct motor data. If the motor is still unstable try reducing the Speed Proportional gain (<code>KVPROP</code>) and Speed Integral gain (<code>KVINT</code>) on the Speed tab of the Fine-tuning window.
I get a Following Error (<code>AXISERROR</code> bit 5 is set) and the drive disables when tuning the Mint gains	Set <code>FOLERRORMODE</code> to zero to ignore the following error while tuning the Mint gains.
I get a Software limit error (<code>AXISERROR</code> bits 3 or 4 set) and the drive disables when tuning the Mint gains	Set <code>SOFTLIMITMODE</code> to zero to ignore the software limit error while tuning the Mint gains.
I get a Hardware limit error (<code>AXISERROR</code> bits 1 or 2 set) and the drive disables when tuning the Mint gains	Set <code>LIMITMODE</code> to zero to ignore the hardware limit errors while tuning the Mint gains. Alternatively, disable the hardware limit inputs.

7.2.6 Status display shows a digit or 'E.'

If the Status display shows a flashing digit, 'E' or the forward or reverse hardware limit symbol, use the Error Log tool to view a list of recent errors. Alternatively, type `PRINT DRIVEERROR`, `PRINT AXISERROR` and `PRINT MISCERROR` as separate commands in the Mint WorkBench Command window. Each of these commands will return an error code, a description of which can be found in the help file.

Press F1 and locate the `DRIVEERROR`, `AXISERROR` and `MISCERROR` keywords. The *Error Handling* book contains topics listing the Status display indicators and basic error codes.

Remember that many error codes are the sum of a bit pattern so may not be listed individually. For help on understanding bit pattern values, see the *Bit pattern values* topic in the *Keywords* book.

8.1 Introduction

This section provides technical specifications for the various FlexDrive^{II} models.

8.1.1 AC input power and motor output - single-phase models

115VAC (Catalog number FDH1... / FPH1...)	Unit	2.5A	5A	7.5A
Nominal input voltage	VAC	115		
Minimum input voltage (recommended / absolute)		97 / 75*		
Maximum input voltage		125		
Nominal input current @ maximum rated output current	ARMS	6.25	12	18
Nominal DC-Bus voltage	VDC	160		
Minimum operating DC-Bus voltage		135		
Maximum operating DC-Bus voltage		176		
Overvoltage safety trip		210		

230VAC (Catalog number FDH2... / FPH2...)	Unit	2.5A	5A	7.5A
Nominal input voltage	VAC	230		
Minimum input voltage (recommended / absolute)		220 / 75*		
Maximum input voltage		250		
Nominal input current @ maximum rated output current	ARMS	6.25	12	18
Nominal DC-Bus voltage	VDC	320		
Minimum operating DC-Bus voltage		306		
Maximum operating DC-Bus voltage		350		
Overvoltage safety trip		420		

* As input voltage decreases, DC-Bus ripple voltage increases. This can cause a deterioration of drive performance.

<i>All single-phase models (Catalog numbers: FDH1... / FPH1... and FDH2... / FPH2...)</i>	Unit	2.5A	5A	7.5A
Output voltage (line-line) @VDC-Bus=320V	VRMS	0 - 230		
Nominal phase current (±10%)	ARMS	2.5	5.0	7.5
Peak phase current (±10%) 2.5A & 5A: for 2.4s (+0.5s / -0s) 7.5A: for 1.25s (+0.5s / -0s)	ARMS	5	10	15
Nominal output power	kVA	1.01	2.17	2.99
Efficiency	%	>95		
Output frequency	Hz	0 - 500		
Nominal switching frequency	kHz	8.0		

8.1.2 AC input power and motor output - 230V three-phase models

230VAC 50/60Hz (Catalog numbers FDH2A15... and FPH2A15...)	Unit	15A
Nominal input voltage	VAC	230
Minimum input voltage (recommended / absolute)		184 / 75*
Maximum input voltage		253
Nominal input current @ maximum rated output current	A_{RMS}	20
Nominal DC-Bus voltage	VDC	320
Minimum operating DC-Bus voltage		258
Maximum operating DC-Bus voltage		355
Oversoltage safety trip		420
Output voltage (line-line) @VDC-Bus=320V	V_{RMS}	0 - 250
Nominal phase current (±10%)	A_{RMS}	15
Peak phase current (±10%) for 1.25s (+0.5s / -0s)	A_{RMS}	30
Nominal output power	kVA	5.2
Efficiency	%	>95
Output frequency	Hz	0 - 500
Nominal switching frequency	kHz	8.0

* As input voltage decreases, DC-Bus ripple voltage increases. This can cause a deterioration of drive performance.

8.1.3 AC input power and motor output - 230-460V three-phase models

230-460VAC 50/60Hz (Catalog number FDH4... / FPH4...)	Unit	2.5A	5A	7.5A	15A	20A	27.5A
Nominal input voltage	VAC	230-460					
Minimum input voltage (recommended / absolute)		180 / 75*					
Maximum input voltage		528					
Nominal input current @ max. rated output current	A_{RMS}	3.5	6.5	10	20	27	36.5
Nominal DC-Bus voltage	VDC	325 (230VAC input) / 650 (460VAC input)					
Minimum operating DC-Bus voltage		254					
Maximum operating DC-Bus voltage		746					
Overvoltage safety trip		840					
Output voltage (line-line) @VDC-Bus=500V	V_{RMS}	0 - 353					
Nominal phase current (±10%)	A_{RMS}	2.5	5.0	7.5	15	20	27.5
Peak phase current (±10%) for 1.25s (+0.5s / -0s)	A_{RMS}	5	10	15	30	40	55
Nominal output power	kVA	1.9	3.8	5.7	11.4	15.2	20.9
Efficiency	%	>95					
Output frequency	Hz	0 - 500					
Nominal switching frequency	kHz	8.0					

* As input voltage decreases, DC-Bus ripple voltage increases. This can cause a deterioration of drive performance.

8.1.4 Customer supplied 24VDC supply input

24VDC (Catalog numbers FDHxxxxx-xxx3 and FPHxxxxx-xxx3)	Unit	2.5A	5A	7.5A	15A	20A	27.5A
Nominal input voltage	VDC	24					
Minimum input voltage		20.4					
Maximum input voltage		28.8					
Maximum ripple	%	±10					
Maximum continuous current @24VDC	A	1.75					
Power on surge current @24VDC, 100ms	A	4					

8.1.5 Regeneration

115VAC (Catalog number FDH1... / FPH1...)	Unit	2.5A	5A	7.5A
Switching threshold	VDC	on: 188-195, off: 183-188		
Nominal power (10% power cycle)	kW	0.25		
Peak power (10% power cycle)	kW	2.7		
Maximum regeneration switching current	A _{RMS}	10		
Maximum load inductance	µH	100		

Note: 2.5A models (FDH1A02... and FPH1A02...) contain an internal 175Ω, 20W resistor.
5A models (FDH1A05... and FPH1A05...) contain an internal 90Ω, 40W resistor.

230VAC (Catalog number FDH2... / FPH2...)	Unit	2.5A	5A	7.5A
Switching threshold	VDC	on: 373-383, off: 362-372		
Nominal power (10% power cycle)	kW	0.25		
Peak power (10% power cycle)	kW	2.7		
Maximum regeneration switching current	A _{RMS}	10		
Maximum load inductance	µH	100		

Note: 2.5A models (FDH2A02... and FPH2A02...) contain an internal 175Ω, 20W resistor.
5A models (FDH2A05... and FPH2A05...) contain an internal 90Ω, 40W resistor.

230VAC three-phase models (Catalog number <i>FDH2A15...</i> / <i>FPH2A15...</i>)	Unit	15A
Switching threshold	VDC	on: 376, off: 365
Nominal power (10% power cycle)	kW	1.0
Peak power (10% power cycle)	kW	15
Maximum regeneration switching current	A_{RMS}	40
Maximum load inductance	μH	100

230-460VAC three-phase models (Catalog number <i>FDH4...</i> / <i>FPH4...</i>)	Unit	2.5A	5A	7.5A	15A	20A	27.5A
Switching threshold $V_{in}=400VAC$ $V_{in}=460VAC$	VDC	on / off: 750			on / off: 750		
Nominal power (10% power cycle)	kW	0.94			2.9		
Peak power (10% power cycle)	kW	9.4			29		
Maximum regeneration switching current	A_{RMS}	15			40	80	
Maximum load inductance	μH	100					

Note: 2.5A models (*FDH4A02...* and *FPH4A02...*) contain an internal 200Ω, 300W resistor.
5A models (*FDH4A05...* and *FPH4A05...*) contain an internal 200Ω, 300W resistor.

8.1.6 Analog input (X3)

<i>All models</i>	Unit	All models
Type		Differential
Common mode voltage range	VDC	±10
Common mode rejection	dB	40
Input impedance	kΩ	>5
Input ADC resolution	bits	14 (includes sign bit)
Equivalent resolution	mV	±1.2
Sampling interval Software (Mint programs) High speed demand reference signal	μs	500 125

8.1.7 Digital inputs (X3)

<i>All models</i>	Unit	All models
Type		Opto-isolated DC inputs
Input voltage (Active high) Nominal Minimum	VDC	24 12
Input voltage (Active low) Nominal Maximum	VDC	0 2
Input current (approximate, per input)	mA	5
Sampling interval	ms	Equivalent to <code>LOOPTIME</code> : 1ms (default) or 2ms
Maximum pulse input frequency (DIN4, pulse and direction mode)	MHz	1
Minimum pulse width (DIN4/DIN5, pulse and direction mode)	ns	250

8.1.8 Digital outputs (X3)

<i>All models</i>	Unit	All models
Output current (maximum, each output)	mA	50
Update interval Software (Mint programs) DRIVEOKOUTPUT, DRIVEENABLEOUTPUT, GLOBALErrorOUTPUT, MOVEOUT, MOVEOUTX, MOVEPULSEOUTX, PULSEOUTX functions PLC Task functions		Immediate Equivalent to <code>LOOPTIME</code> : 1ms (default) or 2ms Programmable

8.1.9 Relay / general purpose output (X3)

<i>All models</i>	Unit	All models
Contacts		Normally closed
Contact rating (resistive)		1A @ 30VDC or 0.5A @ 125VAC
Maximum carrying current	A	2
Maximum switching power		62.5AV, 30W
Maximum switching voltage		250VAC, 220VDC
Maximum switching current	A	2
Capacitance (between open contacts, at 1kHz)	pF	0.5
Update interval Software (Mint programs) DRIVEOKOUTPUT, DRIVEENABLEOUTPUT, GLOBALERROROUTPUT, MOVEOUT, MOVEOUTX, MOVEPULSEOUTX, PULSEOUTX functions PLC Task functions		Immediate Equivalent to LOOPTIME: 1ms (default) or 2ms Programmable

8.1.10 Serial RS232 interface (X6)

<i>All models</i>	Unit	All models
Signal		RS232, non-isolated CTS/RTS
Bit rate	Baud	9600, 19200, 38400, 57600

8.1.11 Serial RS485 interface (X6)

<i>All models</i>	Unit	All models
Signal		4-wire RS485, non-isolated
Bit rate	Baud	9600, 19200

8.1.12 Encoder output (simulated) (X7)

<i>All models</i>	Unit	All models
Signal		RS422
Resolution with resolver input on X8 with encoder input on X8 with absolute encoder input on X8	ppr	Simulated 512 / 1024 / 2048* / 4096* (*Only available if resolver input is set to simulate a 4096ppr source.) Output is a copy of the input on X8 Output ppr equals the number of Sin/Cos cycles per revolution of the input. See section 4.4.1.

8.1.13 Resolver feedback option (X8)

<i>Catalog numbers:</i> <i>FDHxxxxxx-Rxxxx</i> <i>FPHxxxxxx-Rxxxx</i>	Unit	All models
Resolution set automatically by software	bits	14
Resolver winding ratio		0.5
FlexDrive^{II} resolver input accuracy	counts	±3
Typical accuracy using Baldor BSM series resolver motor (with input set to simulate 4096 ppr)	counts	±11
Maximum recommended cable length		30.5m (100ft)

8.1.14 Encoder feedback option (X8)

<i>Catalog numbers:</i> <i>FDHxxxxxx-Exxxx</i> <i>FPHxxxxxx-Exxxx</i>	Unit	All models
Encoder input		A/B Differential, Z index
Maximum input frequency (quadrature)	MHz	8
Hall inputs		Single ended, 5V logic
Output power supply to encoder		5V (±5%), 200mA max.
Maximum recommended cable length		30.5m (100ft)

8.1.15 EnDat (absolute encoder) feedback option (X8)

<i>Catalog numbers:</i> <i>FDHxxxxxx-Dxxxx</i> <i>FPHxxxxxx-Dxxxx</i>	Unit	All models
Absolute encoder input		EnDat Sin/Cos differential inputs and data input
Operating modes (Baldor motors)		Single or multi-turn. 512 or 2048 Sin/Cos cycles per turn, with absolute positioning resolution of up to 65536 steps. (Many other encoder specifications are supported - contact Baldor.)
Output power supply to encoder		5.2V ($\pm 5\%$), 200mA max.
Maximum recommended cable length		30.5m (100ft)

8.1.16 Hiperface (absolute encoder) feedback option (X8)

<i>Catalog numbers:</i> <i>FDHxxxxxx-Hxxxx</i> <i>FPHxxxxxx-Hxxxx</i>	Unit	All models
Absolute encoder input		Hiperface Sin/Cos differential inputs and data input
Operating modes		Single or multi-turn. 512 or 1024 Sin/Cos cycles per turn, with absolute positioning resolution of 2048 or 4096 steps. (Many other encoder specifications are supported - contact Baldor.)
Output power supply to encoder		7V - 11V (supply dependent), 200mA max.
Maximum recommended cable length		30.5m (100ft)

8.1.17 Master (auxiliary) encoder input (X9)

<i>All models</i>	Unit	All models
Signal		RS422
Operating mode		A/B quadrature
Maximum input frequency (quadrature)	MHz	2.5
Sampling interval	ms	Software selectable: 1, 2
Output power supply to encoder		5V, 100mA max.

8.1.18 Pulse and direction input (X9)

<i>All models</i>	Unit	All models
Pulse and direction signals		RS422
Input current (5V input)	mA	1.2mA
Maximum input frequency	MHz	1.25
Sampling interval	ms	Software selectable: 1, 2

8.1.19 Environmental

<i>All models</i>	Unit	All models	
Operating temperature range Minimum Maximum Derate		°C	°F
		+0 +40 2.5% / °C between 40°C and 50°C (max)	+32 +104 2.5% / 1.8°F between 104°F and 122°F (max)
Storage temperature range		-25 to +70	-13 to +158
Humidity	%	10-90 non-condensing according to DIN40 040 / IEC144 Above 31°C (87°F) derate linearly to 50% relative humidity at 40°C (104°F)	
Maximum installation altitude (above m.s.l.)	m	1000 Derate 1.1% / 100m over 1000m	
	ft	3300 Derate 1.1% / 330ft over 3300ft	
Shock		10G according to DIN IEC 68-2-6/29	
Vibration		1G, 10-150Hz, according to DIN IEC 68-2-6/29	

A.1 Introduction

This section describes accessories and options that you may need to use with your FlexDrive^{II}. Shielded (screened) cables provide EMI / RFI shielding and are required for compliance with CE regulations. All connectors and other components must be compatible with the shielded cable.

A.1.1 Factory fitted options

The FlexDrive^{II} can be supplied with a number of factory fitted options. Each option is described in a separate manual that will be supplied with your product as necessary:

- **MN1908 - CAN & Auxiliary I/O Option for Flex+Drive^{II} and MintDrive^{II}.**
Option B provides CANopen and additional input / output capabilities. If this option is fitted, the Flex+Drive^{II} front panel will include connectors X10, X11 and X12.
- **MN1909 - CAN Option for FlexDrive^{II}, Flex+Drive^{II} and MintDrive^{II}.**
Option C provides CANopen capabilities. If this option is fitted, the FlexDrive^{II} front panel will include connectors X10 and X11.
- **MN1910 - DeviceNet Option for FlexDrive^{II}, Flex+Drive^{II} and MintDrive^{II}.**
Option D provides DeviceNet capabilities. If this option is fitted, the FlexDrive^{II} front panel will include connector X15.
- **MN1911 - PROFIBUS DP Option for FlexDrive^{II}, Flex+Drive^{II} and MintDrive^{II}.**
Option P provides Profibus capabilities. If this option is fitted, the FlexDrive^{II} front panel will include connector X14.

A.1.2 Motor power cables

Cable rated current	Cable assembly description	Baldor catalog number	Length	
			m	ft
12 Amps	Power Cable: no connectors	CBL050-501	Available by the meter or on 100m drum.	
	Power Cable Assembly: CE style threaded motor connector (motor end only)	CBL015SP-12*	1.5	5
		CBL025SP-12	2.5	8.2
		CBL030SP-12*	3.0	10
		CBL050SP-12	5.0	16.4
		CBL061SP-12*	6.1	20
		CBL075SP-12	7.5	24.6
		CBL091SP-12*	9.1	30
		CBL100SP-12	10	32.8
		CBL150SP-12	15	49.2
		CBL152SP-12*	15.2	50
CBL200SP-12	20	65.6		
CBL229SP-12*	22.9	75		
20 Amps	Power Cable: no connector	CBL051-501	Available by the meter or on 100m drum.	
	Power Cable Assembly: CE style threaded motor connector (motor end only)	CBL015SP-20*	1.5	5
		CBL025SP-20	2.5	8.2
		CBL030SP-20*	3.0	10
		CBL050SP-20	5.0	16.4
		CBL061SP-20*	6.1	20
		CBL075SP-20	7.5	24.6
		CBL091SP-20*	9.1	30
		CBL100SP-20	10	32.8
		CBL150SP-20	15	49.2
		CBL152SP-20*	15.2	50
CBL200SP-20	20	65.6		
CBL229SP-20*	22.9	75		
35 Amps	Power Cable: no connector	CBL052-501	Available by the meter or on 100m drum.	

* Available in North and South America only.

A.1.3 Motor power cable part numbers

For easier installation, it is recommended that a color-coded Baldor motor power cable is used. A description of a Baldor rotary motor power cable catalog number is shown here, using the example number **CBL025SP-12**:

	Meaning	Alternatives
CBL	The item is a cable	-
025	Indicates the length, in this example 2.5 meters	Various: see section A.1.2.
SP	The cable is a S ervo motor P ower cable	-
12	Current rating of 12A	20 =20A

Motor power cables include the motor power connector. Larger motors requiring 35A cable normally use terminal box connections, so a motor power connector is not required.

A.1.4 Resolver feedback cables

This table lists part numbers of Baldor resolver feedback cables for use with the FlexDrive^{II}:

Cable assembly description	Catalog number	Length	
		m	ft
Resolver Feedback Cable: no connectors	CBL044-501	Available by the meter or on 100m drum.	
Feedback Cable Assembly: CE style threaded motor connector (motor end only)	CBL015SF-R*	1.5	5
	CBL025SF-R	2.5	8.2
	CBL030SF-R*	3.0	10
	CBL050SF-R	5.0	16.4
	CBL061SF-R*	6.1	20
	CBL075SF-R	7.5	24.6
	CBL091SF-R*	9.1	30
	CBL100SF-R	10	32.8
	CBL150SF-R	15	49.2
	CBL152SF-R*	15.2	50
	CBL200SF-R	20	65.6
CBL229SF-R*	22.9	75	
Feedback Cable Assembly: CE style threaded motor connector and 9-pin D-type drive connector	CBL015SF-R1*	1.5	5
	CBL025SF-R1	2.5	8.2
	CBL030SF-R1*	3.0	10
	CBL050SF-R1	5.0	16.4
	CBL061SF-R1*	6.1	20
	CBL075SF-R1	7.5	24.6
	CBL091SF-R1*	9.1	30
	CBL100SF-R1	10	32.8
	CBL150SF-R1	15	49.2
	CBL152SF-R1*	15.2	50
	CBL200SF-R1	20	65.6
CBL229SF-R1*	22.9	75	

* Available in North and South America only.

A.1.5 Encoder / Hall feedback cables

This table lists part numbers of Baldor encoder feedback cables for use with the FlexDrive^{II}:

Cable assembly description	Baldor catalog number	Length	
		m	ft
Encoder Feedback Cable: no connectors	CBL043-501	Available by the meter or on 100m drum.	
Feedback Cable Assembly: CE style threaded motor connector (motor end only)	CBL025SF-E	2.5	8.2
Feedback Cable Assembly: CE style threaded motor connector and high density 15-pin D-type drive connector	CBL015SF-E1*	1.5	5
	CBL025SF-E1	2.5	8.2
	CBL030SF-E1*	3.0	10
	CBL050SF-E1	5.0	16.4
	CBL061SF-E1*	6.1	20
	CBL075SF-E1	7.5	24.6
	CBL091SF-E1*	9.1	30
	CBL100SF-E1	10	32.8
	CBL150SF-E1	15	49.2
	CBL152SF-E1*	15.2	50
CBL200SF-E1	20	65.6	
CBL229SF-E1*	22.9	75	

* Available in North and South America only.

A.1.6 EnDat / Hiperface (absolute encoder) feedback cables

This table lists part numbers of Baldor absolute encoder feedback cables for use with the FlexDrive^{II}:

Cable assembly description	Baldor catalog number	Length	
		m	ft
Absolute Encoder Feedback Cable: no connectors	CBL045-501	Available by the meter or on 100m drum.	
Absolute Encoder Feedback Cable Assembly: CE style threaded motor connector and high density 15-pin D-type drive connector	CBL015SF-D1*	1.5	5
	CBL025SF-D1	2.5	8.2
	CBL030SF-D1*	3.0	10
	CBL050SF-D1	5.0	16.4
	CBL061SF-D1*	6.1	20
	CBL075SF-D1	7.5	24.6
	CBL091SF-D1*	9.1	30
	CBL100SF-D1	10	32.8
	CBL150SF-D1	15	49.2
	CBL152SF-D1*	15.2	50
	CBL200SF-D1	20	65.6
CBL229SF-D1*	22.9	75	

* Available in North and South America only.

A.1.7 Feedback cable part numbers

A description of a Baldor feedback cable catalog number is shown here, using the example number **CBL025SF-R1**:

	Meaning	Alternatives
CBL	The item is a cable	-
025	Indicates the length, in this example 2.5 meters	Various: see sections A.1.4 to A.1.6.
SF	The cable is a S ervo motor F eedback cable	-
R	Resolver feedback cable with motor connector	E =Encoder / Hall feedback cable D =EnDat / Hiperface feedback cable
1	Drive connector included: 9-pin D-type connector (resolver) 15-pin D-type connector (Encoder/Hall & EnDat/Hiperface)	-

Note: Feedback cables have the outer shield tied to the connector housing(s).

If you are not using a Baldor cable with your chosen feedback device, be sure to obtain a cable that is a shielded twisted pair 0.34mm² (22 AWG) wire minimum, with an overall shield. Ideally, the cable should not exceed 30.5m (100ft) in length. Maximum wire-to-wire or wire-to-shield capacitance is 50pF per 300mm (1ft) length, to a maximum of 5000pF for 30.5m (100ft).

A.1.8 EMC filters

AC filters remove high frequency noise from the AC power supply, protecting the FlexDrive^{II}. These filters also prevent high frequency signals from being transmitted back onto the power lines and help meet CE requirements. To select the correct filter, see section 3.4.5.

A.1.8.1 Catalog numbers

Baldor catalog number	Rated volts	Rated amps @ 40°C	Leakage current (mA)	Weight kg (lbs)
FI0014A00	250	3	0.4	0.27 (0.6)
FI0015A00	250	6	0.4	0.45 (0.99)
FI0015A02	250	12	0.4	0.73 (1.61)
FI0018A00	480	7.7	33	0.5 (1.1)
FI0018A01	480	32.9	33	1.2 (2.65)
FI0029A00	250	22	33	3.0 (6.6)

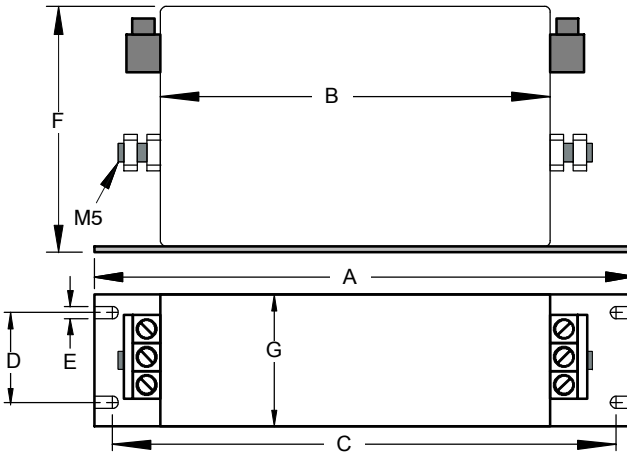

Dimension	Dimensions mm (inches)	
	FI0018A00	FI0018A01
A	190 (7.48)	270 (10.63)
B	160 (6.30)	240 (9.45)
C	180 (7.09)	255 (10.04)
D	20 (0.79)	30 (1.18)
E	4.5 (0.18)	5.4 (0.21)
F	71 (2.80)	85 (3.35)
G	40 (1.57)	50 (1.97)

Figure 46 - Filter dimensions, types FI0018A00 and FI0018A01

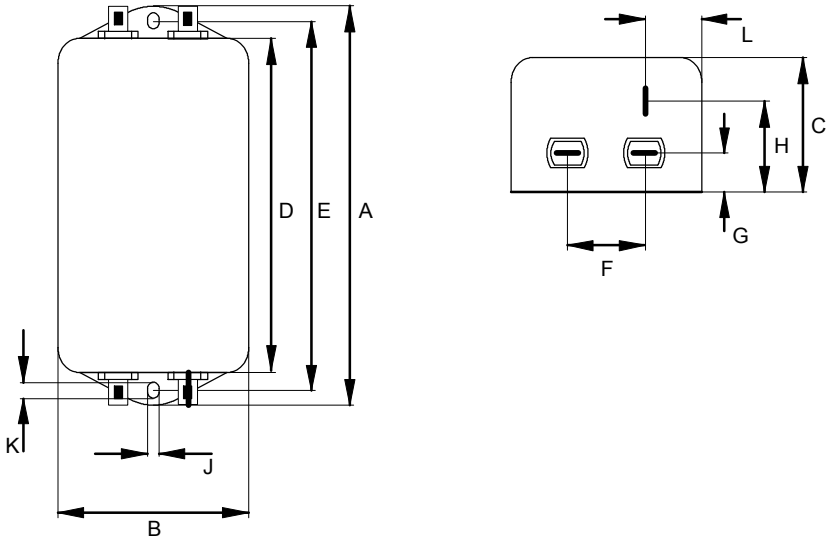

Dimension	Dimensions mm (inches)		
	FI0014A00	FI0015A00	FI0015A02
A	85 (3.35)	113.5 (4.47)	156 (6.14)
B	54 (2.13)	57.5 (2.26)	
C	40 (1.57)	46.6 (1.83)	
D	65 (2.56)	94 (3.70)	130.5 (5.14)
E	75 (2.95)	103 (4.06)	143 (5.63)
F	27 (1.06)	25 (0.98)	
G	12 (0.47)	12.4 (0.49)	
H	29.5 (1.16)	32.4 (1.28)	
J	5.3 (0.21)	4.4 (0.17)	5.3 (0.21)
K	6.3 (0.25)	6 (0.24)	
L	13.5 (0.53)	15.5 (0.61)	

Figure 47 - Filter dimensions, types FI0014A00, FI0015A00 and FI0015A02

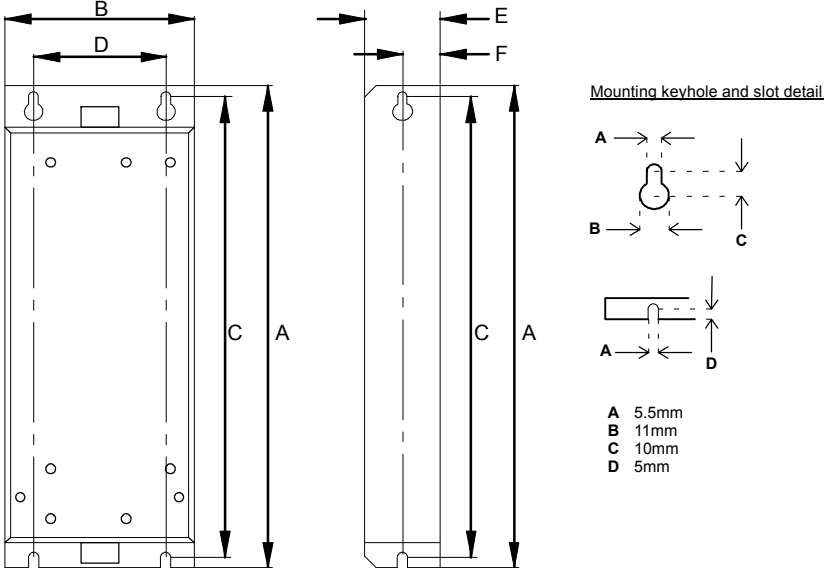

Dimensions shown as: mm (inches).

	Dimensions mm (inches)
Dimension	F10029A00
A	255 (10.04)
B	100 (3.94)
C	244.5 (9.63)
D	70 (2.76)
E	40 (1.57)
F	20 (0.79)

Figure 48 - Filter dimensions, type F10029A00

A.1.9 Regeneration resistors

Some FlexDrive^{II} models (2.5A and 5A) are fitted with an internal regeneration resistor (see sections 2.2.1 and 8.1.5). Additional (external) regeneration resistors can be fitted to these models using the R1 and R2 pins of connector X1/X1A. Resistors connected in this way will be in parallel with the internal resistor.

If an internal resistor is not present, a regeneration resistor should be installed to dissipate energy during braking to prevent an over-voltage error occurring.

FlexDrive ^{II} current rating	115VAC 1Φ models		230VAC 1Φ models		230VAC 3Φ models		230-460VAC 3Φ models	
	Baldor catalog no.	Power rating (W)	Baldor catalog no.	Power rating (W)	Baldor catalog no.	Power rating (W)	Baldor catalog no.	Power rating (W)
2.5A	(Internal)		(Internal)				(Internal)	
5A								
7.5A	RG22	100	RG39	100			RG68	320
15A					RG10	320	RG27A	320*
20A					RG27A	320*		
27.5A					RG11	640		

Note: Where the required dissipation could exceed 320W resistor RG23, rated at 640W, can be used instead.

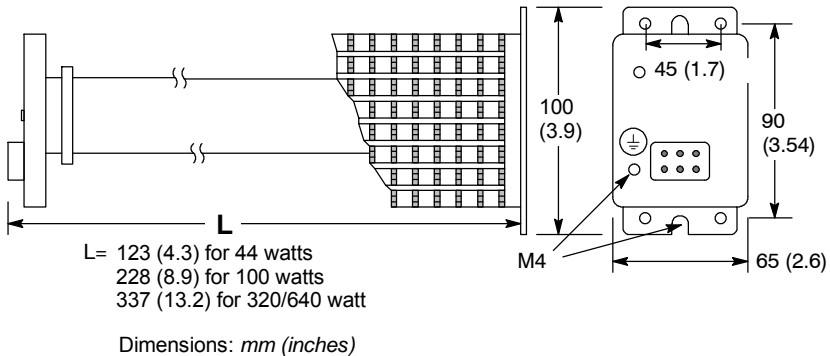

Figure 49 - Regeneration resistor dimensions, all types



WARNING: A regeneration resistor may generate enough heat to ignite combustible materials. To avoid fire hazard, keep all combustible materials and flammable vapors away from the brake resistors. Ensure that the resistor has clearance of at least 50mm (2 in) above and below and 26mm (1 in) left and right. Baldor regeneration resistors are neither internally fused nor thermally protected and, under extreme conditions, can cause a fire hazard if not suitably protected or rated for the application.

B.1 Introduction

The FlexDrive^{II} can be configured for three basic control modes:

- Current (Torque) control
- Velocity (Speed) control
- Position Control (Pulse and Direction following/gearing)

The Flex+Drive^{II} can be configured for three basic control modes:

- Current (Torque) control
- Velocity (Speed) control
- Position Control

The mode you require is selected in Mint WorkBench using the Commissioning Wizard. You can subsequently change between these control modes using the Tools, Control Mode menu item or by using the `CONTROLMODE` keyword in the Command window (see the Mint help file). Using the Parameter tool, you can define a mode for the drive to automatically select at start-up. The four control modes are described in the following sections.

B.1.1 Current (Torque) control

Setting the control mode to Current Control configures the FlexDrive^{II} or Flex+Drive^{II} as a torque amplifier, as shown in Figure 50. Here, a torque reference is obtained from a specified source.

- Mint / host command (profiled)
- High speed analog input (not profiled)
- Analog input (profiled)
- Fieldbus (profiled).

The source provides a signal that can either be fed directly into the Torque controller (only when using the high speed analog input source), or through a profiler. The high speed reference source is ideal for connecting to a motion controller (e.g. NextMove PCI) that will have already profiled the signal and will provide optimum loop closure.

The profiler generates a torque demand signal that smoothly changes between successive torque targets (reference values). This is achieved by specifying a rise time and fall time (see the Mint WorkBench Parameters tool). The torque demand signal is fed into the torque controller which determines the appropriate amount of current to apply to the windings of the motor.

This demand current is compared with the actual winding current measured from sensors, and a suitable pulse width modulation (PWM) signal is generated. This PWM signal is fed to the power electronics in the drive.

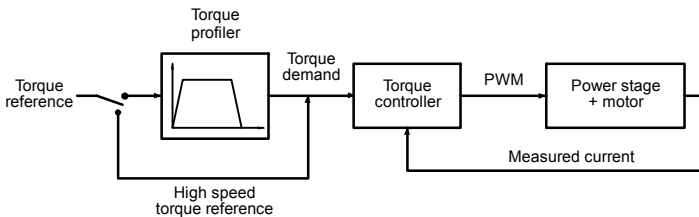

Figure 50 - Control structure in Current (Torque) control mode

B.1.2 Velocity (Speed) control

Setting the control mode to Velocity Control configures the FlexDrive^{II} or Flex+Drive^{II} as a speed amplifier, as shown in Figure 51. Here, a speed reference is obtained from a specified source.

- Mint / host command (profiled)
- High speed analog input (not profiled)
- Analog input (profiled)
- Fieldbus (profiled).

The source provides a signal that can either be fed directly into the Speed controller (only when using the high speed analog input source), or through a profiler. The high speed reference source is ideal for connecting to a motion controller (e.g. NextMove PCI) that will have already profiled the signal and will provide optimum loop closure.

The profiler generates a speed demand signal that smoothly changes between successive speed targets (reference values). This is achieved by specifying acceleration and deceleration times (see the Mint WorkBench Parameters tool). The speed demand signal is fed into the speed controller and used, together with the speed measured from the feedback device, to generate a torque demand signal. If the speed controller is tuned correctly, the measured speed will accurately track the speed demand.

Finally, the torque demand signal is fed into a torque controller, which determines the appropriate amount of current to apply to the windings of the motor. This demand current is compared with the actual winding current measured from sensors, and a suitable pulse width modulation (PWM) signal is generated. This PWM signal is fed to the power electronics in the drive.

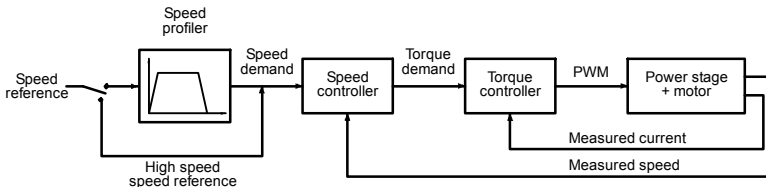

Figure 51 - Control structure in Velocity control mode

B.1.3 Position control (Pulse and Direction)

Setting the control mode to Position Control (Pulse and Direction) configures the FlexDrive^{II} as a positioning system, as shown in Figure 52, capable of following a position demand signal.

The profiler interprets the pulse and direction signals and uses them to generate corresponding position, speed and acceleration demand signals.

The position and speed demand signals are fed into a position controller and used, together with the position measured from the feedback device, to generate a suitable speed demand signal. If the position controller is tuned correctly, the measured position will accurately track the position demand.

The speed demand signal from the position controller is fed into the speed controller and used, together with the speed measured from the feedback device, to generate a torque demand signal. If the speed controller is tuned correctly, the measured speed will accurately track the speed demand. To improve the tracking performance of the speed controller, the profiler acceleration demand is fed in at this point.

Finally, the torque demand signal is fed into a torque controller, which determines the appropriate amount of current to apply to the windings of the motor. This demand current is compared with the actual winding current measured from sensors, and a suitable pulse width modulation (PWM) signal is generated. This PWM signal is fed to the power electronics in the drive.

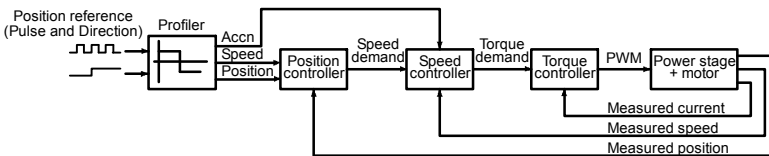

Figure 52 - Control structure in Position control (Pulse and Direction)

B.1.4 Position control

Flex+Drive^{II} only:

Setting the control mode to Position Control configures the Flex+Drive^{II} as a full positioning system, as shown in Figure 53. Here, the Flex+Drive^{II} can be used to command many different position profiles:

- Preset moves
- Absolute or relative moves
- Incremental absolute or relative moves
- Jog control
- Following / Gearing
- Homing

The profiler generates a position demand signal that smoothly changes between successive targets. The profile also generates corresponding speed and acceleration demand signals.

The position and speed demand signals are fed into a position controller and used, together with the position measured from the feedback device, to generate a suitable speed demand signal. If the position controller is tuned correctly, the measured position will accurately track the position demand.

The speed demand signal from the position controller is fed into the speed controller and used, together with the speed measured from the feedback device, to generate a torque demand signal. If the speed controller is tuned correctly, the measured speed will accurately track the speed demand. To improve the tracking performance of the speed controller, the profiler acceleration demand is fed in at this point.

Finally, the torque demand signal is fed into a torque controller, which determines the appropriate amount of current to apply to the windings of the motor. This demand current is compared with the actual winding current measured from sensors, and a suitable pulse width modulation (PWM) signal is generated. This PWM signal is fed to the power electronics in the drive.

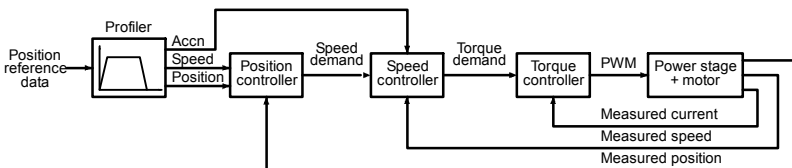

Figure 53 - Control structure in Position control mode

B.2 Control system operation

The following sections describe the operation of the position, speed and torque controllers.

B.2.1 Position controller

The position controller, shown below, is a typical proportional + integral + derivative (PID) controller, with gains set by the Mint keywords `KPROP`, `KINT` and `KDERIV`. The position demand from the profiler is compared with the measured position and the error is fed into the PID control calculation. The resulting value forms the basic speed or torque demand, depending on the `CONFIG` setting. The effect of the integral term can be changed using the `KINTLIMIT` and `KINTMODE` keywords. `KINTLIMIT` sets the maximum value of the effect of integral action, as a percentage of the full scale demand. `KINTMODE` can be used to specify the circumstances under which the integral term is applied.

As an alternative to the derivative term, a velocity feedback term is available by setting keyword `KVEL`.

To improve the tracking performance of the position controller, the profiler speed is fed forward, by gain `KVELFF`, to give a contribution to the final speed or torque demand. The profiler acceleration is fed forward by gain `KACCEL` to give a contribution to the final speed demand. The position control calculation is performed every 500µs.

The gain values `KPROP`, `KINT`, `KDERIV`, `KVEL`, `KVELFF` and `KACCEL` must be tuned for each application. This can either be performed automatically within the Commissioning Wizard, or manually using the Fine-tuning tool in Mint WorkBench.

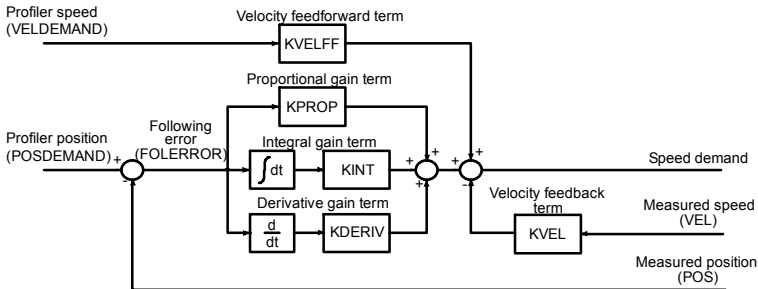

Figure 54 - Position control system

B.2.2 Speed controller

The speed controller, shown in Figure 55, is also a PID controller. Gains are set using the Mint keywords `KVPROP`, `KVINT` and `KVDERIV`. The speed is compared with the measured speed and the error is fed into the PID control calculation. The result forms the torque demand for the torque controller. To improve the performance of the derivative term, an optional filter is included. The time constant of this filter can be set using keyword `KVDERIVTCONST`. By default the filter is turned off, with `KVDERIVTCONST` set to zero.

When the FlexDrive^{II} is set to positioning mode (`CONFIG` is `_cfSERVO`), the profiler acceleration is fed forward by gain `KACCEL` to give a contribution to the final torque demand. The speed control calculation is performed every $250\mu\text{s}$. As with the position controller, the gain values `KVPROP`, `KVINT`, `KVDERIV` and `KACCEL` must be tuned for each application. This can either be performed automatically within the Commissioning Wizard, or manually using the Fine-tuning tool of Mint WorkBench.

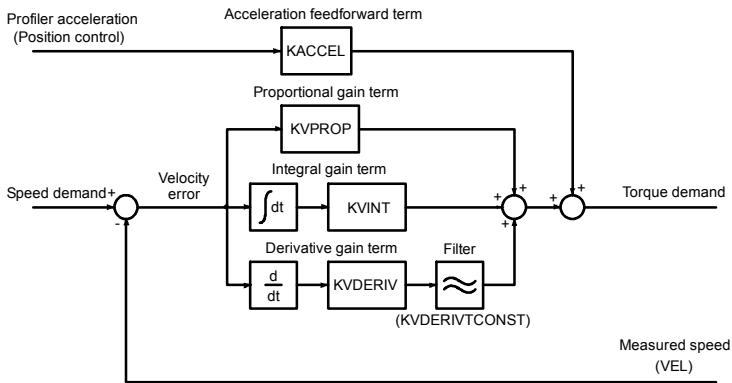

Figure 55 - Speed control system

B.2.3 Torque controller and feedback

The torque controller, shown in Figure 56, is a PI controller. Gains are set using the Mint keywords `KIPROP` and `KIINT`. The torque demand is scaled into a current demand. This is compared with the measured current, obtained from the current sensors, and the error is fed into the PI control calculation. The resulting value forms the PWM signal that is fed through the power stage into the motor windings. The gain values `KIPROP` and `KIINT` must be tuned for a specific motor. This is performed automatically by the Commissioning Wizard.

The feedback device (e.g. an encoder or resolver) is used to determine motor position and speed. Motor speed can be filtered to reduce measurement noise if necessary. The time constant of this filter is specified using the keyword `KVTIME`. By default the filter is turned off (`KVTIME = 0`). Note that introducing a filter on measured speed tends to reduce the stability of the speed controller. This can make the tuning of the speed controller gains difficult if large values of `KVTIME` are used.

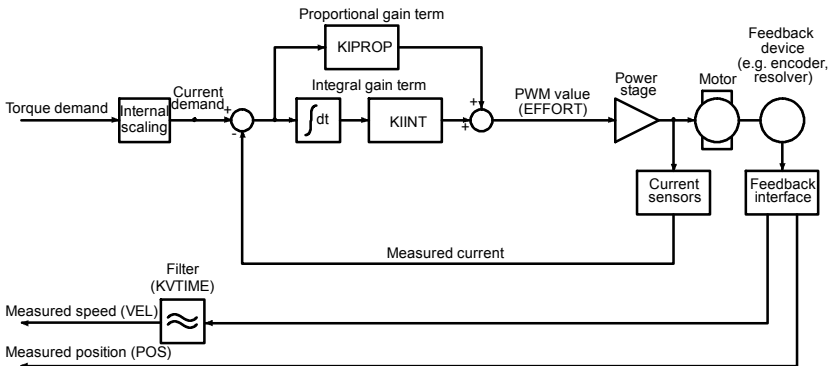

Figure 56 - Torque control system

C.1 Introduction

The following table summarizes the Mint keywords supported by the FlexDrive^{II} and Flex+Drive^{II}. Note that due to continuous developments of the FlexDrive^{II}, Flex+Drive^{II} and the Mint language, this list is subject to change. Check the latest Mint help file for a complete list of new keywords, changed keywords, and those used for controlling program flow.

C.1.1 Keyword listing

Keywords marked with * are supported on Flex+Drive^{II} only.

Keyword	Description
ABORT	To abort motion on all axes.
ABORTMODE	To control the default action taken in the event of an abort.
ABSENCODER	To read the current EnDat or Hiperface encoder position.
ABSENCODERMODE	To compensate for abnormal Hiperface encoder wiring.
ABSENCODEROFFSET	To set the zero point for an EnDat or Hiperface encoder.
ACCEL	To define the acceleration rate of an axis.
ACCELDEMAND	To read the instantaneous demand acceleration.
ACCELTIME	To define the acceleration rate of an axis.
ACCELTIMEMAX	To define the acceleration rate of an axis.
ACTIVERS485NODE	Enables the transmitter on a controller's RS485 port.
ADC	To read an analog input value.
ADCDEADBAND	To set the deadband to be applied to an ADC input.
ADCDEADBANDHYSTERESIS	To set a hysteresis level for entering and leaving the deadband on the ADC inputs.
ADCDEADBANDOFFSET	To set the deadband offset to be applied to an ADC input.
ADCERROR	To read back the analog inputs currently in error.
ADCERRORMODE	Controls the default action taken in the event of an ADC limit being exceeded on an associated channel.
ADCGAIN	To set the gain to be applied to an ADC input.

Keyword	Description
ADCMAX	Sets the upper analog limit value for the specified analog input.
ADCMIN	Sets the lower analog limit value for the specified analog input.
ADCMODE	To set the analog input mode.
ADCMONITOR	Specifies the analog inputs that an axis will monitor for analog limit checking.
ADCOFFSET	To set the offset to be applied to an ADC input.
ADCOFFSETTRIM	To zero (trim) the specified analog input.
ADCTIMECONSTANT	To set the time constant of the low pass filter applied to an ADC input.
ASYNCEERRORPRESENT	To determine whether an asynchronous error is present.
Auto	To automatically execute a program on power-up.
AUTOHOMEMODE	To set the autohome mode for the specified configuration.
AUTOSTARTMODE	To set the autostart mode for the specified configuration.
AUXENCODER	To set or read the auxiliary encoder input.
AUXENCODERMODE	To make miscellaneous changes to the auxiliary encoders.
AUXENCODERROLLOVER	To count the number of wraps of the auxiliary encoder value.
AUXENCODERSCALE	To set or read the scale factor for the auxiliary encoder input.
AUXENCODERSPEED	Specifies a (virtual) speed reference for the auxiliary encoder.
AUXENCODERVEL	To read the velocity of the auxiliary encoder input.
AUXENCODERWRAP	To set or read the encoder wrap range for the auxiliary encoder input.
AUXENCODERZEROENABLE	To re-enable Z pulse capturing on the auxiliary encoder
AUXENCODERZEROLATCHMODE	To control the latching mechanism for the auxiliary encoder's Z latch.
AUXENCODERZEROPOSITION	To read the auxiliary encoder position at the last Z capture.
AUXENCODERZLATCH	To read the state of the auxiliary encoder's Z latch.

Keyword	Description
AXISERROR	To read back the motion error.
AXISMODE	To return the current mode of motion.
AXISPOSENCODER *	To select the source of the position signal used in dual encoder feedback systems.
AXISSTATUS	To return the current error status from the specified axis.
AXISSTATUSWORD	To read the DS402 status word for a remote axis.
AXISWARNING	To read or clear present axis warnings.
AXISWARNINGDISABLE	Allows individual axis warnings to be enabled and disabled.
BRIDGECOMPENABLE	To enable or disable bridge circuit compensation.
BRIDGEERRORCURRENT	To set the current parameter used when compensating for non-linearities in the drive's PWM bridge.
BRIDGEERRORVOLTAGE	To set the voltage parameter used when compensating for non-linearities in the drive's PWM bridge.
Bus	To specify which fieldbus is to be used as the default.
BUSBAUD	To specify the bus baud rate.
BUSCOMMANDMASK	Defines a bit mask for CANopen, DeviceNet and PROFIBUS Command telegrams.
BUSEVENT	Returns the next event in the bus event queue of a specific bus.
BUSEVENTINFO	Returns the additional information associated with a bus event.
BUSNODE	To set or read the node ID used by this node for the specified bus.
BUSPROCESSDATAIN	To configure the drive for the type of process data that will be received from the master.
BUSPROCESSDATAIN-DATATYPE	To configure the data type for process data that will be received from the master.
BUSPROCESSDATAIN-PARAMETER	To define the associated parameter for items received in process data telegrams.
BUSPROCESSDATAOUT	To configure the type of process data that will be sent by the drive.
BUSPROCESSDATAOUT-DATATYPE	To configure the data type for process data that will be sent by the drive.

Keyword	Description
BUSPROCESSDATAOUT-INTERVAL	To define the update interval for information sent in process data telegrams.
BUSPROCESSDATAOUT-PARAMETER	To define the associated parameter for items sent in process data telegrams.
BUSRESET	Resets the bus controller.
BUSSTATE	Returns the status of the bus controller.
BUSTIMEOUT	To alter the inter-character timeout for MODBUS ASCII.
CAMBOX *	To start or stop a CAMBox channel.
CAMBOXDATA *	To load data associated with a CAMBox channel.
CANCEL	To stop motion and clear errors on an axis.
CANCELALL	To stop motion and clear errors on all axes.
CAPTURECOMMAND	Controls the operation of capture.
CAPTUREBUFFERSIZE	To read the total size of the capture buffer.
CAPTURECHANNELINTEGER-UPLOAD	To allow an entire channel of captured data values to be uploaded as integer data into an array.
CAPTURECHANNELUPLOAD	To allow an entire channel of captured data values to be uploaded into an array.
CAPTUREDURATION *	To define the total duration of the data capture.
CAPTUREHSMODE	To set or read the mode of a high speed capture channel.
CAPTUREINTERVAL	To define the interval between data captures, relative to the servo frequency.
CAPTUREMODE	To set or read the mode on a capture channel.
CAPTUREMODEPARAMETER	To specify a parameter associated with CAPTUREMODE.
CAPTURENUMPOINTS	To read the number of captured points per channel.
CAPTUREPERIOD	To define the interval between data captures.
CAPTUREPOINT	To allow individual capture values to be read.
CAPTUREPOINTINTEGER	To allow individual capture values to be read as integer values.
CAPTUREPRETRIGGER-DURATION	Sets the duration of the pre-trigger phase.
CAPTUREPROGRESS	Returns the progress of the pre-trigger or post-trigger capture phase.

Keyword	Description
CAPTURESTATUS	Returns the progress of the capture.
CAPTURETRIGGER	To generate a capture trigger.
CAPTURETRIGGERABSOLUTE	To ignore the sign of the trigger value when triggering from a capture channel source.
CAPTURETRIGGERCHANNEL	Sets the channel to be used as the reference source for triggering.
CAPTURETRIGGERMODE	Sets the method used to evaluate the trigger source.
CAPTURETRIGGERSOURCE	Sets the reference source to be used for triggering.
CAPTURETRIGGERVALUE	Sets the trigger value when triggering from a capture channel source.
COMMISSIONED	To set or read whether the axis/drive has been commissioned.
COMMS	Accesses the reserved comms array.
COMMSINTEGER *	Accesses the reserved comms array, storing values as integers.
COMMSMAPDATATYPE	To define the data type of a comms element.
COMMSMAPMODE	To set or read the comms mapping for a comms element.
COMMSMAPPARAMETER	To set or read the associated parameter for a mapped comms element.
COMMSMODE *	Selects comms use over either RS485 or CANopen.
CONFIG	To set the configuration of an axis for different control types.
CONNECTSTATUS	Returns the status of the connection between this node and another node.
CONTROLMODE	To set or read the control mode.
CURRENTLIMIT	To restrict the current output to a defined range.
CURRENTMEAS	Reads the measured current.
DECEL	To set the deceleration rate on the axis.
DECELTIME	To set the deceleration rate on the axis.
DECELTIMEMAX	To define the deceleration rate of an axis.
DPREVENT *	To interrupt the host PC and generate a trappable event, using the Dual Port RAM (DPR).

Keyword	Description
DRIVEBUSNOMINALVOLTS	To return the nominal value of the DC bus voltage for the drive.
DRIVEBUSOVERVOLTS	To set or return the overvoltage trip level for the drive.
DRIVEBUSUNDERVOLTS	To set or return the undervoltage trip level for the drive.
DRIVEBUSVOLTS	To return the current level of the DC bus.
DRIVEENABLE	To enable or disable the drive for the specified axis.
DRIVEENABLEINPUTMODE	To control the action taken in the event of the drive being disabled from the drive enable input/enable DIP switch.
DRIVEENABLEMODE	To set the drive to auto-enable on power on.
DRIVEENABLEOUTPUT	To specify an output as a drive enable.
DRIVEENABLESWITCH	To read the state of the drive enable input.
DRIVEERROR	To report errors on the drive or to clear current drive errors.
DRIVEFEEDBACK	To read the type of feedback module.
DRIVEID	To define a text description for the drive.
DRIVEOKOUTPUT	To assign a digital output as the Drive OK output.
DRIVEOVERLOADAREA	Reads the extent of a drive overload condition.
DRIVEOVERLOADMODE	Sets or reads the action taken in the event of a drive overload condition.
DRIVEPEAKCURRENT	Reads the peak current rating of the drive.
DRIVEPEAKDURATION	Reads the duration for which peak drive current can be sustained.
DRIVERATEDCURRENT	Reads the continuous current rating for the drive.
DRIVESPEEDFATAL	To define the overspeed trip level.
DRIVESPEEDMAX	To set or read the maximum motor speed to be used.
EFFORT	To read the instantaneous effort applied by the current controllers.
ENABLESWITCH	To read the state of the Drive Enable DIP switch.
ENCODER	To set or read the axis encoder value.
ENCODERLINESIN	To set or read the number of encoder lines (pre-quadrature) for the drive feedback.
ENCODERLINESINSPEEDMAX	To read the maximum allowable speed when using a resolver feedback device.

Keyword	Description
ENCODERLINESOUT	To define the resolution of the encoder output.
ENCODERMODE	To make miscellaneous changes to the encoders.
ENCODERSCALE	To set or read the scale factor for the encoder channel.
ENCODERVEL	To read the velocity from an encoder channel.
ENCODERWRAP	To set or read the encoder wrap range for the encoder channel.
ENCODERZLATCH	To get and reset the state of an axis' encoder Z latch.
ERRORDECEL	To set the deceleration rate on the axis for powered stops, in the event of an error or stop input.
ERRORINPUT	To set or return the digital input to be used as the error input for the specified axis.
ERRORINPUTMODE	To control the default action taken in the event of an external error input.
ERRORLOGCLEAR	To clear the error log.
ERRORLOGMODE	To specify how the the error log is updated.
ERRORLOGSAVE	To save the error log to non-volatile EEPROM memory.
ERRORSWITCH	To return the state of the error input.
EVENTACTIVE	Indicates whether an event is currently active.
EVENTDISABLE	To selectively enable and disable Mint events.
EVENTPENDING	To indicate whether an event is currently pending.
FACTORYDEFAULTS	To reset parameter table entries to their default values.
FASTAUXENABLE	To manually clear the auxiliary encoder's fast position latch.
FASTAUXENCODER	To return the instantaneous auxiliary encoder value that was recorded on the fast interrupt.
FASTAUXLATCH	To read the auxiliary encoder fast interrupt latch.
FASTAUXLATCHDISTANCE	To specify the distance over which further auxiliary encoder latch edges will be ignored.
FASTAUXLATCHEDGE	To select the capture edge for fast capture on the auxiliary encoder.
FASTAUXLATCHMODE	Sets the default action to be taken to clear the auxiliary encoder's fast position latch.
FASTAUXSELECT	To select which of the fast position capture inputs will capture an auxiliary encoder channel.

Keyword	Description
FASTENABLE *	Manually clears the encoder's fast position latch.
FASTENCODER *	To return the instantaneous encoder value that was recorded on the fast interrupt.
FASTLATCH *	To read the axis fast interrupt latch.
FASTLATCHEDGE *	To define which edge polarity should cause the fast position to be captured.
FASTLATCHMODE *	To set the default action to be taken to clear the encoder's fast position latch.
FASTPOS *	To return the instantaneous axis position that was recorded on the fast interrupt.
FASTSELECT *	To select which of the fast position capture inputs (or outputs) will cause axis position to be captured.
FEEDBACKFAULTENABLE	To enable or disable detection of motor feedback faults.
FEEDRATE *	To set the slew speed of an individual move loaded in the move buffer.
FEEDRATEMODE *	To control the use of slew speed, acceleration, deceleration and feedrate override.
FEEDRATEOVERRIDE *	Overrides the current speed or feedrate being used.
FIRMWARERELEASE	To read the release number of the firmware.
FIRMWAREVERSION	To read the version number of the firmware.
FOLEERROR	To return the instantaneous following error value.
FOLEERRORFATAL	To set the maximum permissible following error before an error is generated.
FOLEERRORMODE	To determine the action taken on the axis in the event of a following error.
FOLEERRORWARNING	Sets the following error threshold before an axis warning is generated.
FOLLOW	To enable encoder following with a specified gear ratio.
FOLLOWMODE	To define the mode of operation of the FOLLOW keyword.
FOLLOWNUMERATOR	To set or read the follow ratio's numerator.
GLOBALERROROUTPUT	Allows the user to specify a global error output which will be deactivated in the event of an error.
GO	To begin synchronized motion.

Keyword	Description
GROUPCOMMS	To write to the comms arrays of all the nodes within a specified group.
GROUPMASTERSTATUS	To determine whether the current node is master of the group.
GROUPSTATUS	To determine whether the current node is a member of the group.
HALL	To read the current Hall state on feedback devices which use Hall sensors.
HALLFORWARDANGLE	To define the electrical angles at which Hall states change, when the motor is running in the forward direction, for feedback devices which use Hall sensors.
HALLREVERSEANGLE	To define the electrical angles at which Hall states change, when the motor is running in the reverse direction, for feedback devices which use Hall sensors.
HALLTABLE	To define the Hall table for an encoder motor.
HOLDSWITCH	To read the current state of the Hold DIP switch.
HOME *	To find the home position on an axis.
HOMEACCEL *	To set the acceleration rate for the homing profile.
HOMEBACKOFF *	To set the home back-off speed factor.
HOMECREEPSPEED *	To set the creep speed for homing moves.
HOMEDECEL *	To set the deceleration rate for the homing profile.
HOMEINPUT *	To set a digital input to be the home switch input for the specified axis.
HOMEOFFSET *	Apply an offset to the homing sequence.
HOMEPHASE *	To find the phase of the homing sequence currently in progress.
HOMEPOS *	To read the axis position at the completion of the homing sequence.
HOMEREFPOS *	To define a reference position for homing moves.
HOMESPEED *	To set the speed for the initial seek phase of the homing sequence.
HOMESTATUS *	To set or read the status of a homing sequence.
HOMESWITCH *	To return the state of the home input.
HOMETYPE *	To set the homing mode to be performed at start-up.

Keyword	Description
IDLE	Indicates if a move has finished executing and the axis has finished moving.
IDLEMODE	To control the checks performed when determining if an axis idle.
IDLEPOS	Reads or sets the idle following error limit.
IDLESETTLINGTIME	To read the time taken for an axis to become idle.
IDLETIME	To specify the period for which the axis must meet its idle conditions before becoming idle.
IDLEVEL	Reads or sets the idle velocity limit.
IMASK	To mask off Mint events IN0 .. INx
IN	To read the state of all the inputs on an input bank.
INCA *	To set up an incremental move to an absolute position.
INCR *	To set up an incremental move to a relative position.
INITERROR	To report any errors detected during start-up.
INITWARNING	Returns the sum of a bit pattern describing initialization warnings generated at start-up.
INPUTACTIVELEVEL	To set the active level on the digital inputs.
INPUTMODE	To set or return the sum of a bit pattern describing which of the user digital inputs should be edge or level triggered.
INPUTNEGTRIGGER	To set or return the user inputs that become active on negative edges.
INPUTPOSTRIGGER	To set or return the user inputs that become active on positive edges.
INSTATE	To read the state of all digital inputs.
INSTATEX	To read the state of an individual digital input.
INX	To read the state of an individual digital input.
JOG	To set an axis for speed control.
JOGCOMMAND	To start or stop a jog by giving a direction command.
JOGDURATION	To specify the duration of a timed jog.
JOGMODE	To specify the control mode for profiling a jog move.
JOGSPEED	To define a preset jog speed.
JOGTIME	To return the remaining jog time before deceleration.

Keyword	Description
KACCEL	To set the servo loop acceleration feed forward gain.
KDERIV	To set the servo loop derivative gain on the servo axes.
KIINT	To set the integral gain used by the current controller.
KINT	To set the servo loop integral gain.
KINTLIMIT	To restrict the overall effect of the integral gain KINT.
KINTMODE	To control when integral action will be applied in the servo loop.
KIPROP	To set the proportional gain used by the current controller.
KPROP	To set the proportional gain for the position controller.
KVDERIV	To set the derivative gain used by the speed controller.
KVDERIVTCONST	To set the time constant used by the filter on the derivative gain term of the speed controller.
KVEL	To set the servo loop velocity feedback gain term.
KVELFF	To set the velocity feedforward term for the position controller.
KVINT	To set the integral gain used by the speed controller.
KVPROP	To set the proportional gain used by the speed controller.
KVTIME	To set the time constant of a low pass filter, applied to measured speed.
LED	To set or read the display mode for the seven segment display.
LEDDISPLAY	To set or read the value for the seven segment display.
LIFETIME	Returns a lifetime counter for the drive.
LIMIT	To return the state of the forward and reverse limit switch inputs for the given axis.
LIMITFORWARD	To return the state of the forward limit switch input for the given axis.
LIMITFORWARDINPUT	To set the user digital input configured to be the forward end of travel limit switch input for the specified axis.
LIMITMODE	To control the default action taken in the event of a forward or reverse hardware limit switch input becoming active.

Keyword	Description
LIMITREVERSE	To return the state of the reverse limit switch input for the given axis.
LIMITREVERSEINPUT	To set the user digital input configured to be the reverse end of travel limit switch input for the specified axis.
LOADDAMPING	To define the equivalent viscous damping coefficient for the motor and load.
LOADINERTIA	To define the combined inertia of the motor and load.
LOOPTIME	To set the servo loop update interval in microseconds.
MASTERCHANNEL	To set or read the channel of the input device used for gearing.
MASTERDISTANCE	To set the distance on the master axis over which the slave will travel for a 'segment' in master-slave move types.
MASTERSOURCE	To set or read the source of the input device used for gearing.
MAXSPEED	To set a limit for the speed demanded on an axis.
MISCERROR	To read or clear the miscellaneous error flag.
MISCERRORDISABLE	To enable or disable miscellaneous errors calling the error event.
MOTORBRAKE *	To manually override motor brake control.
MOTORBRAKEDELAY *	To specify engage/disengage delays associated with motor brake control.
MOTORBRAKEMODE *	To activate or deactivate motor brake control.
MOTORBRAKEOUTPUT *	To specify an output to be used as a control signal for a braked motor.
MOTORBRAKESTATUS *	To determine the state of the motor brake control.
MOTORCATALOGNUMBER	To return the catalog number of the motor.
MOTORDIRECTION	To set or read the electrical direction of the motor.
MOTORENCODERLINES	To set or read the number of encoder lines (pre-quadrature) for the motor.
MOTORFEEDBACK	To set or read the feedback type of the motor.
MOTORFEEDBACKOFFSET	To set or read the electrical angle at which the absolute position read from an EnDat or Hiperface encoder is zero.

Keyword	Description
MOTORFEEDBACKPROTOCOL- ERROR	To read the type of feedback error when using a Hiperface encoder.
MOTORFEEDBACKPROTOCOL- RETRIES	To set or read the number of retries to attempt when an error occurs on a Hiperface encoder.
MOTORFEEDBACKSTATUS	To read the current status of the EnDat or Hiperface encoder.
MOTORFLUX	To set the motor's magnetic flux level, to allow the drive to accurately calculate motor torque and compensate for back-EMF.
MOTORLINEARENCODER- RESOLUTION	To set the resolution of the encoder on a linear motor.
MOTORLINEARPOLEPITCH	To set or read the distance between north poles on a linear motor.
MOTORLS	To set or read the motor leakage inductance.
MOTOROVERLOADAREA	Reads the extent of an overload condition.
MOTOROVERLOADMODE	To set or read the action taken in the event of a motor overload condition.
MOTORPEAKCURRENT	To set or read the peak current rating of the motor.
MOTORPEAKDURATION	To set or read the duration for which peak motor current can be sustained.
MOTORPOLES	To set or read the number of motor poles.
MOTORPOWERMEASURED	To read the instantaneous electrical power applied to the motor.
MOTORRATEDCURRENT	To set or read the rated current of the motor.
MOTORRESOLVEROFFSET	To set the feedback alignment for a resolver motor.
MOTORRS	To set the motor stator resistance.
MOTORSPECNUMBER	To return the spec number of the motor.
MOTORTEMPERATUREINPUT	To assign a digital input as the motor overtemperature trip input.
MOTORTEMPERATURESWITCH	To read the state of the motor overtemperature trip input.
MOVEA *	To set up a positional move to an absolute position.
MOVEBUFFERFREE *	To return the number of free spaces in the move buffer for the specified axis.
MOVEBUFFERID *	To attach or read back a 16-bit identifier from the move buffer.

Keyword	Description
MOVEBUFFERIDLAST *	To read a 16-bit identifier from the move buffer.
MOVEBUFFERLOW *	To set or return the number of free spaces in the move buffer before a move buffer low event is generated.
MOVEBUFFERSIZE *	To set or return the size of the move buffer allocated on the specified axis.
MOVEBUFFERSTATUS *	To return information about the move buffer.
MOVEDWELL *	To load a dwell move into the move buffer.
MOVEOUT *	To load a digital output bit pattern into the move buffer.
MOVEOUTX *	To load a change of state for a specific digital output into the move buffer.
MOVEPULSEOUTX *	To load a pulsed change of state for a specific digital output into the move buffer.
MOVER *	To set up a positional move to a relative position.
MOVESTATUS	To return information about the progress of the current move.
NODE	To set or read the node ID used by this node.
NODELIVE	To determine if a CAN node on the bus is currently live or dead.
NODETYPE	To add or remove a CAN node to/from the CAN network. Can also be read to determine the node type.
NUMBEROF	To return information about the abilities of the controller.
NUMBEROFEXTENDED	To return information about the abilities of the controller.
OFFSET *	To perform a positional offset move.
OFFSETMODE *	Define the mode of operation on the OFFSET keyword.
OFFSETSTATUS *	To read the status of the previous offset move.
OUT	To set or read the state of all the outputs on an output bank.
OUTPUTACTIVELEVEL	To set the active level on the digital outputs.
OUTX	To set or read an individual digital output.
PARAMSAVEMODE	To allow parameters to be stored in EEPROM during run-time.
PHASESEARCHBACKOFF	To select the back-off distance used to clear an end stop during the phase search sequence.

Keyword	Description
PHASESEARCHBANDWIDTH	To define the bandwidth used to design the 'debounce' controller used during the initial alignment stage of the phase search sequence.
PHASESEARCHCURRENT	To select amount of current applied to the motor during the phase search sequence.
PHASESEARCHMODE	To turn on the 'debounce' controller used during the initial alignment stage of the phase search sequence.
PHASESEARCHSPEED	To select the speed of travel during the search sections of a phase search sequence.
PHASESEARCHSTATUS	To determine whether commutation is aligned on an axis.
PHASESEARCHTRAVEL	To select the amount of travel during the search sections of a phase search sequence.
PLATFORM	To return the platform type.
PLCACTION	To read the action assigned to a PLC Task channel.
PLCACTIONPARAMETER	To read the associated parameter for an action assigned to a PLC Task channel.
PLCAUTOENABLE	To specify whether the PLC Task will be automatically enabled on power-up.
PLCCONDITION	To read a PLC test condition.
PLCDEFAULT	To reset the PLC Task table to default settings
PLCENABLE	To enable/disable the PLC Task.
PLCENABLEACTION	To enable/disable individual PLC Task channels.
PLCGEARFACTOR	To set or read the gear factor used by the 'Fast Gear' PLC action.
PLCOPERATOR	To read the operator for a PLC Task channel.
PLCPARAMETER	To read the associated parameter used by a PLC Task channel's condition.
PLCSTATUS	To read a bit pattern of active (true) PLC Task channels.
PLCTASK	To set up PLC Task channels.
PLCTASKSTATUS	To read the current state of an individual PLC Task.
PLCTIME	To set or read the frequency of a PLC Task.
POS	To set or read the current axis position.
POSACHIEVED	To indicate whether the axis is 'in position'.

Keyword	Description
POSDEMAND	To set or read the instantaneous position demand.
POSREMAINING	To indicate the remaining move distance.
POSROLLOVER	To count the number of wraps of the axis position value.
POSTARGET	Reads the target position of the current positional move.
POSTARGETLAST	To read the target position of the last move in the move buffer.
POSWRAP	To set or read the position wrap range for the axis.
PRESETCANCEL	To set up a preset 'move' to perform a cancel command.
PRESETDWELLTIME	To specify a dwell time between a hardware trigger and the preset move starting.
PRESETHOME *	To set up a homing type preset move.
PRESETINDEX	To read the current preset index or set a new index.
PRESETINDEXMODE	To set the controller's response to changes in a preset index.
PRESETINDEXSOURCE	To define the source for preset index changes.
PRESETINPUTSMAX	To define the number of preset moves available in the preset table.
PRESETINPUTSTATE	To read the current state of digital inputs representing the preset index.
PRESETJOG	To set up a jog preset move.
PRESETMOVEA *	To set up an absolute preset move.
PRESETMOVEENABLE	Enables or disables preset moves.
PRESETMOVEPARAMETER	To define a preset move's parameters.
PRESETMOVER *	To set up a relative preset move.
PRESETMOVESUSPEND	To pause a preset move.
PRESETMOVETYPE	To define the type of preset move.
PRESETPOS *	To set up a preset 'move' to set the axis position value.
PRESETSELECTORINPUT	To assign the base input for preset index selection.
PRESETSPEEDREF	To set up a fixed point speed reference preset move.
PRESETSTOP	To set up a preset 'move' to perform a stop command.
PRESETTORQUEREF	To set up a fixed point torque reference preset move.

Keyword	Description
PRESETTRIGGERINPUT	To assign the input to be used as the preset index trigger.
PRODUCTCATALOGNUMBER	To return the catalog number of the controller.
PRODUCTSERIALNUMBER	To return the serial number of the controller.
PROFILEMODE	To select the type of velocity profiler to use.
PULSECOUNTER	To return the value of the pulse input counter.
PULSEDIRMODE	To set the control mode for the step (pulse) & direction digital inputs.
PULSEOUTX	To activate a digital output for a specified number of milliseconds.
RELAY	To enable or disable the relay.
REMOTEADC *	To read the value of a remote analog input (ADC).
REMOTEADCDELTA *	To control the rate of change on a remote analog input before a REMOTEADC message is sent.
REMOTEIN *	To read the state of all the digital inputs on a remote CAN node.
REMOTEINBANK *	To read the state of a bank of digital inputs on a remote CAN node.
REMOTEINHIBITTIME *	To set or read the CANopen PDO inhibit time.
REMOTEINX *	To read the state of individual digital inputs from a remote CAN node.
REMOTEMODE *	To control the update mode for a remote node.
REMOTEOBJECT	To access the Object Dictionary of any CANopen node present on the network.
REMOTEOUT *	To control the state of digital outputs on a remote CAN node.
REMOTEOUTBANK *	To read the state of a bank of digital outputs on a remote CAN node.
REMOTEOUTX *	To control the state of individual digital outputs on a remote CAN node.
REMOTEPDOIN *	To request data from a node in the form of a PDO message.
REMOTEPDOOUT *	To force a Baldor controller node to transmit a variable length PDO message with a specific COB-ID. The PDO will contain up to 64 bits of data that can be passed in the form of two 32-bit values.

Keyword	Description
REMOTESTATUS	To set or read the status register on a remote CAN node.
RESET	To clear motion errors, set the position to zero and re-enable the drive.
RESETALL	To perform a reset on all axes.
RESETINPUT	To define the reset input for an axis.
SCALEFACTOR	To scale axis encoder counts, or steps, into user defined units.
SENTINEL	To set up sentinel channels.
SENTINELLATCH	To determine whether a sentinel channel has become true since it was last checked.
SENTINELSOURCE	To read the source used by a sentinel channel.
SENTINELSOURCEPARAMETER	To read the source parameter used by a sentinel channel.
SENTINELTRIGGERABSOLUTE	To read the 'absolute' parameter used by a sentinel channel.
SENTINELTRIGGERMODE	To read the 'mode' parameter used by a sentinel channel.
SENTINELTRIGGERVALUE	To read the 'lowVal' or 'highVal' parameter used by a sentinel channel.
SERIALBAUD	To set the baud rate of the RS232 / RS485/422 port.
SEXTANT	To read the current sextant value for a motor using Hall sensors.
SOFTLIMITFORWARD	To set the forward software limit position on a specified axis.
SOFTLIMITMODE	To set or read the default action taken if a forward or reverse software limit position is exceeded.
SOFTLIMITREVERSE	To set or read the reverse software limit position on a specified axis.
SPEED *	To set or read the slew speed of positional moves loaded in the move buffer.
SPEEDEMAND	To read the speed demand.
SPEEDERROR	To return the error between the demanded speed and the measured speed.
SPEEDERRORFATAL	To set or read the trip limit for the error between demanded and measured speed.

Keyword	Description
SPEEDMEASURED	To return the measured speed.
SPEEDREF	To set or read a fixed point speed reference.
SPEEDREFACCELTIME	To set or read the acceleration ramp for a speed profile.
SPEEDREFDECELTIME	To set or read the deceleration ramp for a speed profile.
SPEEDREFDEMAND	To read the calculated speed demand.
SPEEDREFENABLE	To enable speed command mode.
SPEEDREFERRORDECELTIME	Sets a deceleration ramp for a speed profile in the event of an error.
SPEEDREFSOURCE	To specify the source of the speed reference command.
SRAMP *	Sets the percentage of S-ramping applied to linear moves.
STOP	To perform a controlled stop during motion.
STOPINPUT	To set or read the digital input to be used as the stop switch input for the specified axis.
STOPINPUTMODE	To set or read the action taken in the event of a stop input becoming active.
STOPSWITCH	To return the current state of the stop input for the axis.
SUSPEND	To pause the current move.
SYSTEMDEFAULTS	To reset parameter table entries to their default values and erase the Mint program, NVRAM and error log.
SYSTEMSECONDS	To set or read a programmable system lifetime counter for the drive.
SYSTEMTIMEMODE	To specify whether system time data is stored to non-volatile memory.
TEMPERATURE	To report the internal drive temperature.
TEMPERATURELIMITFATAL	To set or read the temperature fatal limit.
TEMPERATURELIMITWARNING	To read the temperature warning limit.
TERMINALDEVICE	To set or read the device type associated with a given terminal.
TERMINALMODE	To set or read handshaking modes for a terminal.
TERMINALPORT	To set or read the communication port associated with a given terminal.
TIMEREVENT *	To set or read the rate of the timer event.
TIMESCALE	To scale speed related values into user time units.

Keyword	Description
TORQUEDEMAND	To return the instantaneous torque demand.
TORQUELIMITNEG	To set or read the maximum negative torque limit.
TORQUELIMITPOS	To set or read the maximum positive torque limit.
TORQUEREF	To set or read a torque reference for torque (constant current) mode on a servo axis.
TORQUEREFENABLE	To set the drive into torque command mode.
TORQUEREFERRORFALLTIME	To set or read the 'deceleration ramp' for a torque profile in the event of an error.
TORQUEREFALLTIME	To set or read the 'deceleration ramp' for a torque profile.
TORQUEREFRISETIME	To set or read the 'acceleration ramp' for a torque profile.
TORQUEREFSOURCE	To specify the source of the torque reference command.
TRIGGERCHANNEL *	Controls the channel used as the trigger source.
TRIGGERINPUT *	To specify the input used for triggering, when triggering on a digital input.
TRIGGERMODE *	Controls the triggering of a move.
USERPARAMETER	To provide access to user-programmable parameters stored in EEPROM.
USERPOSITIONUNITS	To define a text description for the user unit.
USERTIMEUNITS	To define a text description for the user time unit.
VEL	To return the instantaneous axis velocity.
VELDEMAND	To read the current instantaneous demand velocity.
VELError	To report the velocity following error.
VELFATAL	To set or read the threshold for the maximum difference between demand and actual velocity.
VELFATALMODE	To control the default action taken in the event of the velocity threshold being exceeded.
VELSETPOINTMAX	To set or read the maximum limit of a velocity band.
VELSETPOINTMIN	To set the minimum limit of a velocity band.

* These keywords are supported on Flex+Drive^{II} only.

D.1 Introduction

This section provides general information regarding recommended methods of installation for CE compliance. It is not intended as an exhaustive guide to good practice and wiring techniques. It is assumed that the installer of the FlexDrive^{II} is sufficiently qualified to perform the task, and is aware of local regulations and requirements. Baldor products that meet the EMC directive requirements are indicated with a “CE” mark. A duly signed CE declaration of conformity is available from Baldor.



D.1.1 EMC Conformity and CE marking

The information contained herein is for your guidance only and does not guarantee that the installation will meet the requirements of the council directive 89/336/EEC.

The purpose of the EEC directives is to state a minimum technical requirement common to all the member states within the European Union. In turn, these minimum technical requirements are intended to enhance the levels of safety both directly and indirectly.

Council directive 89/336/EEC relating to Electro Magnetic Compliance (EMC) indicates that it is the responsibility of the system integrator to ensure that the entire system complies with all relative directives at the time of installing into service.

Motors and controls are used as components of a system, per the EMC directive. Hence all components, installation of the components, interconnection between components, and shielding and grounding of the system as a whole determines EMC compliance.

The CE mark informs the purchaser that the equipment has been tested and complies with the appropriate standards. It rests upon the manufacturer or his authorized representative to ensure the item in question complies fully with all the relative directives in force at the time of installing into service, in the same way as the system integrator previously mentioned. Remember that it is the instructions of installation and the product that should comply with the directive.

D.1.2 Declaration of conformity



Date: 01/06/02 **EC Declaration of Conformity** Ref: DE00011-001

Manufacturer: Baldor UK Limited
Address: Mint Motion Centre, Hawkley Drive, Bristol Distribution Centre, Bristol, BS32 0BF, United Kingdom

This is to certify that MintDrive^{II}, FlexDrive^{II} and Flex+Drive^{II} single-axis Servo and Positioning Drives, being one of:-

MDH1Axxxx-xxxx	FPH1Axxxx-xxxx	FDH1Axxxx-xxxx
MDH2Axxxx-xxxx	FPH2Axxxx-xxxx	FDH2Axxxx-xxxx
MDH4Axxxx-xxxx	FPH4Axxxx-xxxx	FDH4Axxxx-xxxx

built after the 1st January 2002, when used in accordance with the guidance given in the corresponding Installation Manuals MN1901 (MintDrive^{II}) or MN1902 (FlexDrive^{II} and Flex+Drive^{II}), conforms with the protection requirements of Council Directive 89/336/EEC relating to Electromagnetic Compatibility, by the application of the following standards:-

Standard: EN61800-3 : 1996	Title: <i>Adjustable speed electrical power drive systems Part 3: EMC Product standard, including specific test methods.</i>	Comments: Emissions & Immunity comply with both the first (domestic) and second (industrial) environments.
--------------------------------------	--	--

and in detail with the following basic standards:

Standard: EN 61800-3 : 1996	Title: <i>Conducted Emissions</i>
EN 61800-3 : 1996	<i>Radiated Emissions</i>
EN 61000-4-2 : 1995	<i>ElectroStatic Discharge</i>
EN 61000-4-3 : 1995	<i>Radiated Field Immunity</i>
EN 61000-4-4 : 1995	<i>EFT/Bursts</i>
EN 61000-4-5 : 1995	<i>Surge Immunity</i>
EN 61000-4-6 : 1996	<i>Conducted Immunity</i>

and with the protection requirements of Council Directive 72/23/EEC (amended by 93/68/EEC) relating to Low Voltage Equipment, by following the guidance found in the following standard:

Standard: EN50178 : 1997	Title: <i>Electronic equipment for use in power installations.</i>
------------------------------------	--

Signed:

Dr. Gerry Boast
Engineering Manager

D.1.3 Use of CE compliant components

The following points should be considered:

- **Using CE approved components will not guarantee a CE compliant system!**
- The components used in the drive, installation methods used, materials selected for interconnection of components are important.
- The installation methods, interconnection materials, shielding, filtering and earthing/grounding of the system as a whole will determine CE compliance.
- The responsibility of CE mark compliance rests entirely with the party who offers the end system for sale (such as an OEM or system integrator).

D.1.4 EMC wiring technique

Cabinet

Using a typical electroplated zinc coated enclosure, connected to earth/ground, means that all parts mounted on the back plane are connected to earth/ground and all outer shield (screen) connections can be connected to earth/ground. Within the cabinet there should be a spatial separation between power wiring (motor and AC power cables) and control wiring.

Shield (screen) connections

All connections between components must use shielded cables. The cable shields must be connected to the enclosure. Use conductive clamps to ensure good earth/ground connection. With this technique, a good earth/ground shield can be achieved.

EMC filters

The filter should be mounted next to the FlexDrive^{II}. The connections between the FlexDrive^{II} and the filter should use shielded (screened) cables. The cable shields should be connected to shield clamps at both ends. An exception to this is the analog demand signal.

Earthing/grounding

For safety reasons (VDE0160), all Baldor components must be connected to earth/ground with a separate wire. Earth/ground connections must be made from the central earth/ground (star point) to the regeneration resistor enclosure and from the central earth/ground (star point) to the power supply.

D.1.5 EMC installation suggestions

To ensure electromagnetic compatibility (EMC), the following installation points should be considered to help reduce interference:

- Earthing/grounding of all system elements to a central earth/ground point (star point)
- Shielding of all cables and signal wires
- Filtering of power lines.

A proper enclosure should have the following characteristics:

- All metal conducting parts of the enclosure must be electrically connected to the back plane. These connections should be made with an earthing/grounding strap from each element to a central earthing/grounding point (star point). *
 - Keep the power wiring (motor and power cable) and control wiring separated. If these wires must cross, be sure they cross at 90 degrees to minimize noise due to induction.
 - The shield connections of the signal and power cables should be connected to the shield rails or clamps. The shield rails or clamps should be conductive clamps fastened to the cabinet. **
 - The cable to the regeneration resistor must be shielded. The shield must be connected to earth/ground at both ends.
 - The location of the AC filter has to be situated close to the drive so the AC power wires are as short as possible.
 - Wires inside the enclosure should be placed as close as possible to conducting metal, cabinet walls and plates. It is advised to terminate unused wires to chassis ground.*
 - To reduce earth/ground current, use the largest suitable wire available for earth/ground connections.
- * Earthing/grounding in general describes all metal parts which can be connected to a protective conductor, e.g. housing of cabinet, motor housing, etc. to a central earth/ground point (star point). This central earth/ground point (star point) is then connected to the main plant (or building) earth/ground.
- ** Or run as twisted pair at minimum.

D.1.6 Wiring of shielded (screened) cables

Remove the outer insulation to expose the overall shield. Clamp should provide 360° contact with the cable.

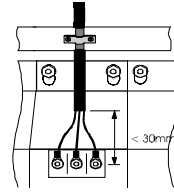
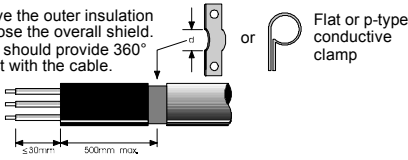

Figure 57 - Earthing/grounding cable shields

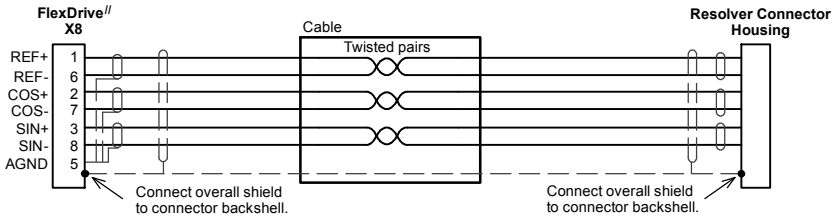

Figure 58 - Resolver cable grounding

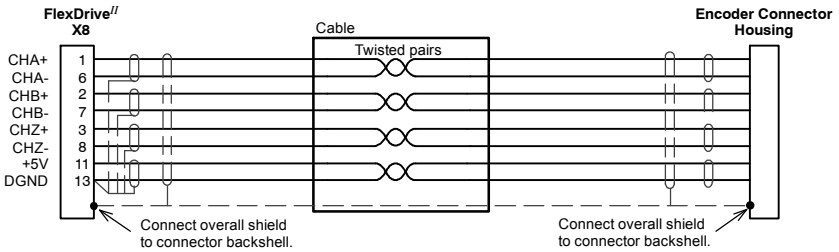

Figure 59 - Encoder signal cable grounding

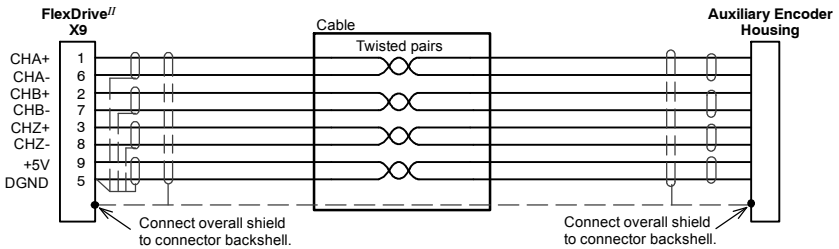

Figure 60 - Auxiliary Encoder cable grounding

D.2 UL file numbers

The following table lists UL file numbers for Baldor products and other accessories. Note that UL file numbers for accessories that are not manufactured by Baldor are beyond Baldor's control and therefore subject to change without notice.

UL file number	Company	Description
E128059	Baldor Electric Co.	Drives
E46145	Baldor Electric Co.	Motors
E132956	Cabloswiss s.p.a.	Power cables (6A, 12A, 20A, 25A, 50A, 90A) Encoder cables Resolver/SSI cables EnDat cables
E192076	Unika Special Cables s.p.a	Power cables (6A, 12A, 20A, 25A, 50A, 90A) Encoder cables Resolver/SSI cables EnDat cables
E153698	Coninvers GmbH	Connectors
E64388	Schaffner EMV AG	AC filters
E70122	Epcos AG	AC filters
E212934	Frizlen GmbH & Co. KG	Regeneration (brake) resistors
E227820	RARA Electronics Corp.	Regeneration (brake) resistors

A

Abbreviations. *See* Units and Abbreviations

Absolute encoder

 cable, 3-28, 3-30, A-4

 Hiperface option, 3-29

 option, 3-27

 specification, 8-10

Accessories, A-1

 EMC filters, A-6

 feedback cables, A-3, A-4

 motor power cables, A-2

 regeneration resistors, A-9

Analog I/O, 4-1

 analog input - X3 (demand), 4-2

B

Basic Installation, 3-1

C

Catalog number, identifying, 2-2

CE Guidelines, D-1

 declaration of conformity, D-2

Commissioning Wizard, 5-7

 completing, 5-7

 using, 5-7

Configuration, 5-9

 performing a test move, 5-8

Connections

See also Input / Output

 feedback, 3-21

 motor, 3-15

 motor brake, 3-19

 power, 3-8

 single phase, 3-9

 three phase, 3-10

 thermal switch, 3-18

Connector, locations, 3-7

Control system, B-1

 current (torque) control, B-2

 operation

 position controller, B-6

 speed controller, B-7

 torque controller and feedback, B-8

 position control, B-5

 position control (pulse & direction), B-4

 velocity (speed) control, B-3

D

DB On LED, 7-5

Digital I/O, 4-4

 CREF, 4-6

 digital inputs - X3, 4-5

 digital outputs - X3, 4-9, 4-10

 pulse & direction, 4-6

 special functions, 4-8

Dimensions, 3-6

DIP switches, 3-33

 1-4: Node select, 3-33

 5: Hold, 3-34

 6: RS485 terminator, 3-34

 7: Offset tuning, 3-34, 5-3

 8: Enable, 3-34

 9 & 10: RS232/RS485 select, 3-35

 factory settings, 3-35

 preventing a program running, 3-36

Drive enable

 command, 3-32

 DIP switch 8, 3-32

 X3 CREF, 3-31

Dual encoder feedback, following, 4-14

Dynamic brake. *See* Regeneration resistor

E

Encoder

 absolute. *See* Absolute encoder

 cable, 3-25, A-4

 Hiperface. *See* Absolute encoder

 option, 3-24

specification, 8-9
EnDat. *See* Absolute encoder
Environmental
location, 3-4–3-5
specification, 8-11

F

Factory fitted options, A-1
Factory settings, 3-35
Features, 2-1
Feedback
absolute encoder, 3-27, 3-29
cable, A-3–A-5
connections, 3-21
encoder, 3-24
resolver, 3-22

Filters

24V control supply, 3-14
AC power (EMC), 3-12, A-6
catalog numbers, A-6

G

General Information, 1-1

H

Hardware requirements, 3-1
Help file, 5-4
Hiperface. *See* Absolute encoder

I

Indicators, 7-2
DB On LED, 7-5
Status display, 7-2
Input / Output, 4-1
analog I/O, 4-1
analog input - X3, 4-2, 8-6
connection summary, 4-19
digital I/O, 4-4
digital inputs - X3, 4-5, 8-7
digital outputs - X3, 4-9, 4-10, 8-7
encoder output - X7, 4-11, 8-9
master encoder input - X9, 4-13, 8-10
option connectors, 4-20
relay - X3, 4-10, 8-8
serial port - X6, 4-15, 8-8
connecting Baldor HMI panels, 4-18
multidrop using RS485/RS422 cable, 4-17

using RS232 cable, 4-16

Installation

See also Basic Installation
dimensions, 3-6
mechanical, 3-4
mounting, 3-5

K

Keyword summary, C-1

L

LED indicators
DB On, 7-5
Status display, 7-2

M

Mint keyword summary, C-1
Mint WorkBench, 5-4
Commissioning Wizard, 5-7
digital I/O tool, 5-12
fine-tuning tool, 5-9
help file, 5-4
other tools and windows, 5-12
parameters tool, 5-11
starting, 5-5

Motor

circuit contactors, 3-16
connections, 3-15
power cable, 3-16–3-17, A-2
sinusoidal filter, 3-17

Motor brake, connection, 3-19

Mounting, 3-5

O

Operation, 5-1
connecting to the PC, 5-1
installing software, 5-1
offset tuning, 3-34, 5-3
power on checks, 5-2
preliminary checks, 5-2
starting, 5-2

Options, A-1

P

PLC Task, 6-7
defining conditions, 6-7
enabling and downloading, 6-8

saving conditions, 6-9
testing, 6-9

Power

24V control supply, 3-14
connections, 3-8
disconnect and protection devices, 3-11
input conditioning, 3-11
input cycling, 3-11, 7-1
sources, 3-1
supply filters, 3-12, A-6

Precautions, 1-2

Preset moves, 6-2

CAN & Auxiliary I/O option, 6-6
controlling, 6-6
defining, 6-2
saving, 6-9
testing, 6-3
using digital inputs, 6-3

Product Notice, 1-2

Pulse & Direction

following, 4-14
specification, 8-7, 8-11
X3 - DIN4/5, 4-6
X9, 4-13

R

Receiving and Inspection, 2-2

Regeneration

controlling, 3-20
resistor, 3-20
specification, 8-5

Relay

output, 4-10
specification, 8-8

Resolver

cable, 3-23, A-3
option, 3-22
specification, 8-9

RS232

cable, 4-16
specification, 8-8
X6, 4-15

RS485 / RS422

specification, 8-8
systems, 3-2

X6, 4-15–4-18

S

Safety Notice, 1-2

Specifications, 8-1

115V / 230V single-phase models, 8-2
230V three-phase models, 8-3
230V-460V three-phase models, 8-4
24V control supply, 8-5
absolute encoder feedback - X8, 8-10
analog input - X3, 8-6
digital inputs - X3, 8-7
digital outputs - X3, 8-7
encoder feedback - X8, 8-9
encoder output - X7, 8-9
environmental, 8-11
Hiperface feedback - X8, 8-10
master encoder input - X9, 8-10
pulse & direction inputs - X9, 8-11
regeneration, 8-5
relay output - X3, 8-8
resolver feedback - X8, 8-9
serial RS232 interface - X6, 8-8
serial RS485 interface - X6, 8-8
Status display, 7-2

T

Thermal switch, connection, 3-18

Tools, 3-2

Troubleshooting, 7-1

communication, 7-5
DB On LED, 7-5
power cycling, 7-1
power on, 7-6
problem diagnosis, 7-1
Status display, 7-2
SupportMe, 7-1
tuning, 7-6

U

UL file numbers, D-6

Units and abbreviations, 2-3

W

Wire sizes, 3-13

If you have any suggestions for improvements to this manual, please let us know. Write your comments in the space provided below, remove this page from the manual and mail it to:

Manuals
Baldor UK Ltd
Mint Motion Centre
6 Bristol Distribution Park
Hawkley Drive
Bristol
BS32 0BF
United Kingdom.

Alternatively, you can e-mail your comments to:

manuals@baldor.co.uk

Comment:

continued...



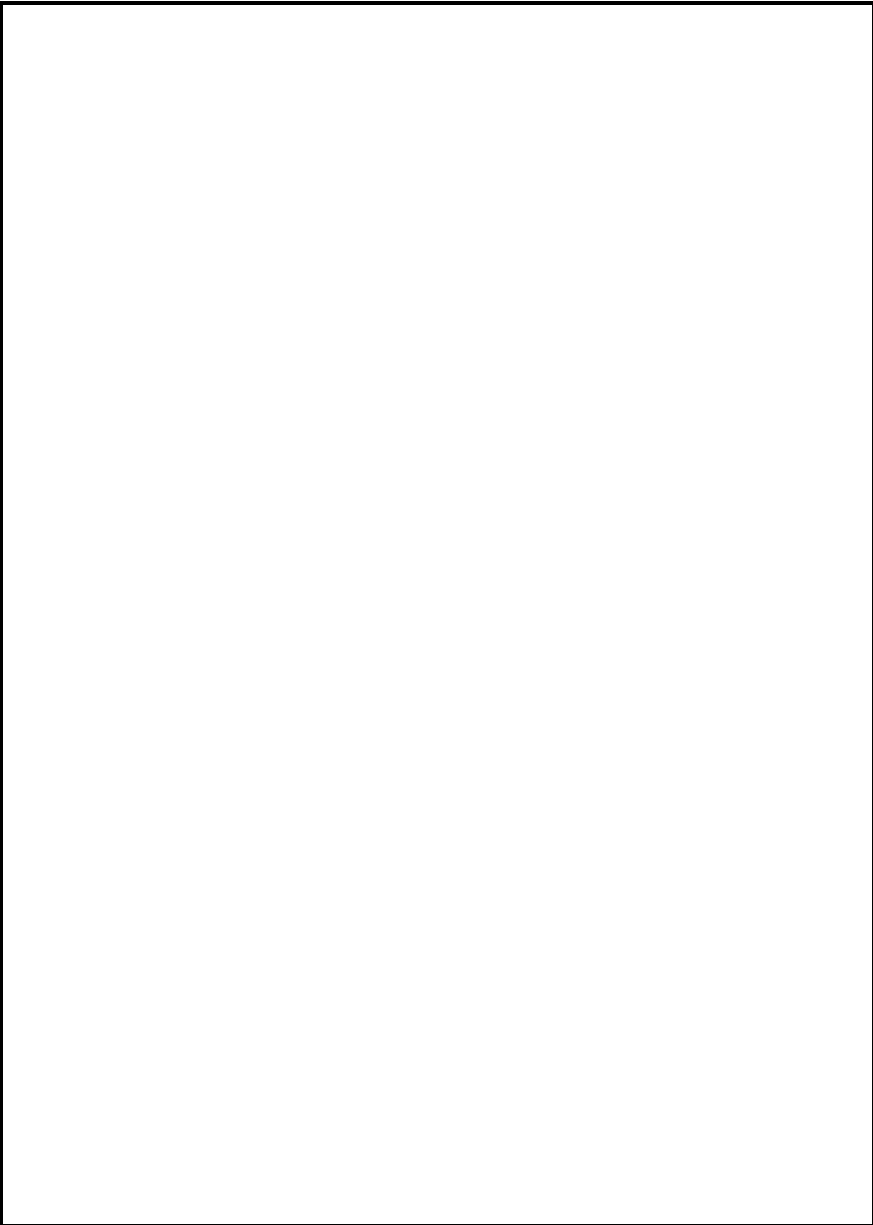

Thank you for taking the time to help us.



Baldor Electric Company
P.O. Box 2400
Ft. Smith, AR 72902-2400
U.S.A.

Visit www.baldormotion.com for the latest documentation and software releases.

U.S.A. (Headquarters)

Baldor Electric Company
Tel: +1 479 646 4711
Fax: +1 479 648 5792

Australia Australian Baldor PTY Ltd Tel: +61 2 9674 5455 Fax: +61 2 9674 2495	Japan Baldor Japan Corporation Tel: +81 45 412 4506 Fax: +81 45 412 4507
Europe Baldor ASR GmbH, Germany Tel: +49 (0) 89 905 080 Fax: +49 (0) 89 905 08492	Mexico Baldor de Mexico Tel: +52 477 761 2030 Fax: +52 477 761 2010
Europe (Southern) Baldor ASR AG, Switzerland Tel: +41 52 647 4700 Fax: +41 52 659 2394	Singapore Baldor Electric PTE Ltd Tel: +65 6744 2572 Fax: +65 7474 1708
India Baldor Electric India Pvt Ltd Tel: +91 20 25 45 27 17 Fax: +91 20 25 45 27 19	United Kingdom Baldor UK Ltd Tel: +44 1454 850000 Fax: +44 1454 859001
For additional office locations visit www.baldor.com	

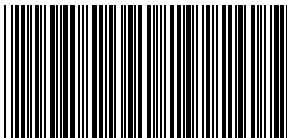

LT0160A05

Printed in UK
© Baldor UK Ltd