

BRECO *flex* CO., L.L.C.

High Precision Drive Components

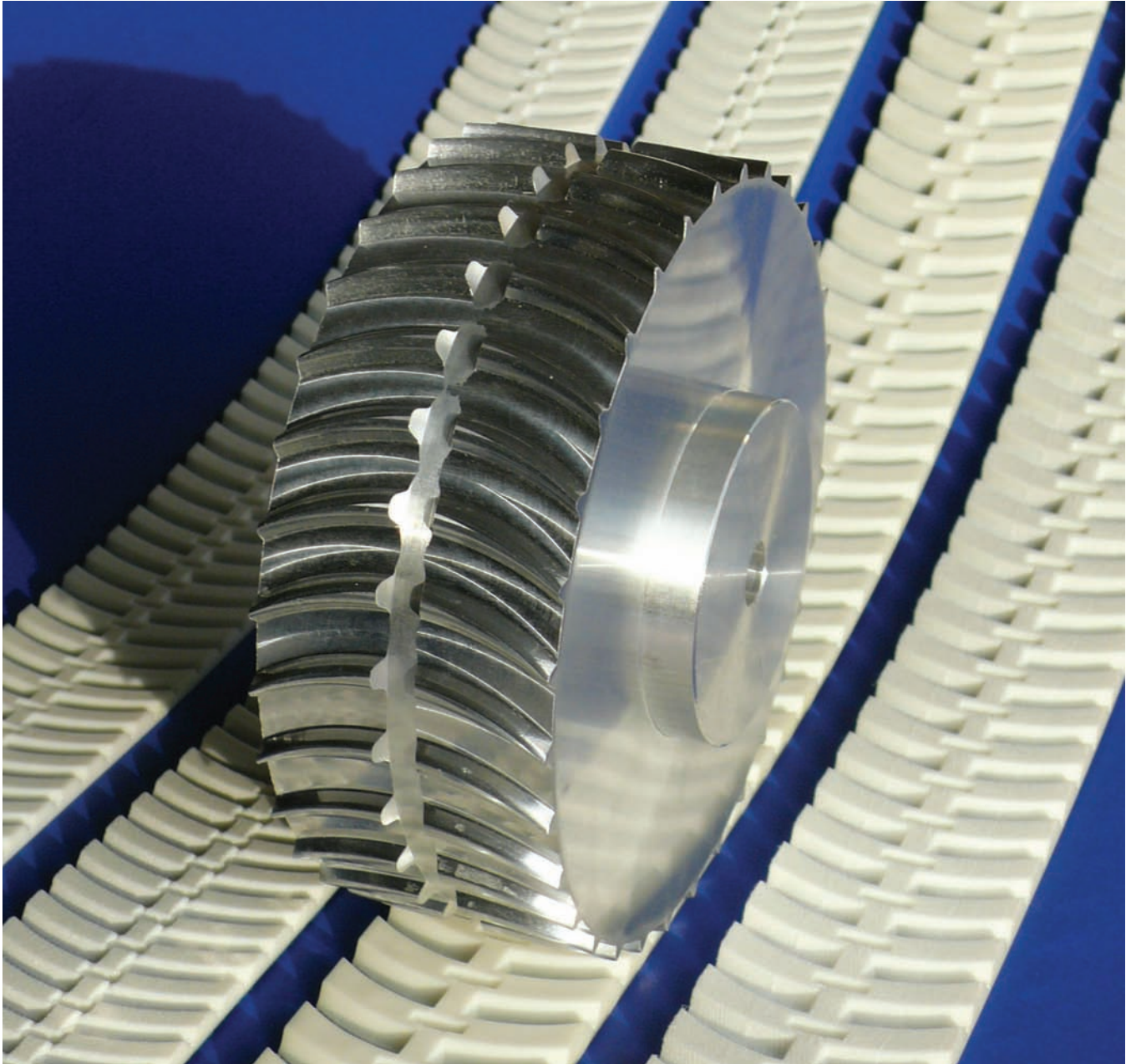

ARC-POWER[®]

TECHNOLOGY

ARC-POWER TECHNOLOGY

REINFORCED POLYURETHANE ARC-POWER TIMING BELTS

The revolutionary "arc" shaped state-of-the-art timing belt design represents the most unique and efficient timing belt available. This world-wide patented timing belt technology incorporates numerous performance advantages.

ADVANTAGES

The ARC-POWER design allows design engineers to incorporate the most efficient and smooth performing timing belt technology available leading to the following advantages:

- Continuous Tooth Engagement
- Smooth Meshing of Belt and Pulleys
- Less Vibration
- Reduced Noise Level
- Self-Tracking, No Flanges
- No Pulley Flanges
- Decreased Polygonal Effect
- No Lateral Movement
- Increased Power Range
- Improved Repeatability
- Friction Reduced Tracking
- Smooth Idler Interaction
- More Compact Design
- Tangential Belt Drive Possible

APPLICATIONS

Numerous high performance special applications can now be accomplished by utilizing the ARC-POWER timing belt technology. The ARC-POWER Technology is the preferred choice for following applications:

- Linear Drives
- Power Transmission Applications
- Conveying
- Indexing
- Positioning and Driving Applications

REINFORCED POLYURETHANE ARC-POWER TIMING BELTS

ARC-POWER is available in **Open Ended**, **Welded** and **Truly Endless** (homogeneous-no splice) with steel cord tension members and is offered in AT10 and AT15 tooth profile and with an integrated tracking guide. This design offers the ideal timing belt for high precision linear drives, conveying and power transmission applications.

ARC-POWER VERSION “BATK” - (with tracking guide)

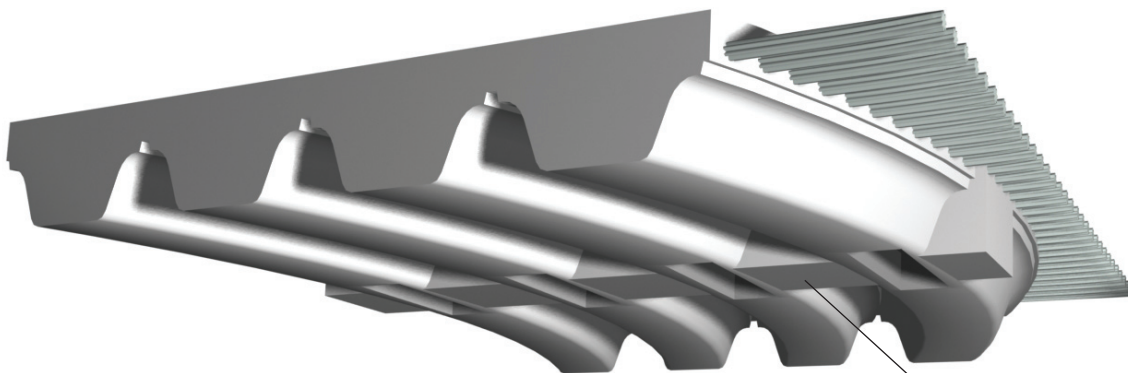

BATK10 / BATK15

TRACKING GUIDE

← BI-DIRECTIONAL →

Nylon Facing Options:

	Version	PAZ (TOOTH SIDE)	PAR (BACK SIDE)	PAZ-PAR
BATK10	M (open ended)	white	green	white / green
	V (welded)	white	green	white / green
	BFX (truly endless)	white	green	white / green
BATK15	M (open ended)	white	green	white / green
	V (welded)	white	green	white / green
	BFX (truly endless)	white	green	white / green

NOTE: For ARC-POWER timing belts with backings or ARC-POWER timing belts with profiles, call applications engineering.

ARC-POWER TECHNOLOGY

TECHNOLOGY CHARACTERISTICS

The circular tooth design is specifically developed to provide drive components for state-of-the-art applications requiring highest positioning accuracy and reliability. The outstanding performance is based on the extremely low friction during belt and pulley engagement.

Smooth Tooth Engagement

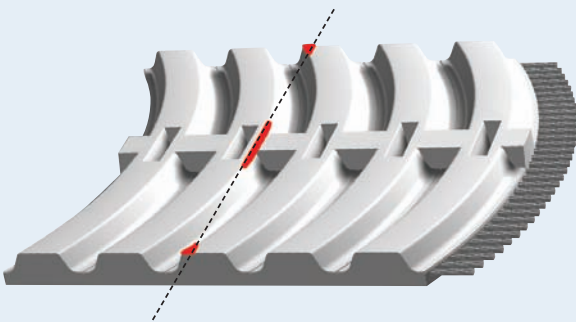

The unique circular "arc" tooth meshing enables the transmission of force dynamically during the point of engagement of belt and pulley. While the radial point of tooth engagement is constantly shifting and the "arc" shaped timing belt tooth passes the pulley centerline, the succeeding tooth is already engaged and avoids tooth snapping into the pulley tooth gap. This results in smooth self-tracking intermeshing and leads to optimal drive characteristics by reducing the polygonal surface of belt and pulley. This also leads to reduced vibration and less noise which is of high importance in today's high demanding design criterias.

Circular Power Distribution

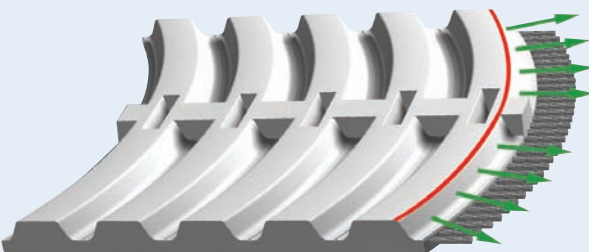

The circular "arc" tooth shape has been scientifically developed to optimize belt and pulley meshing, therefore improving the dynamics and drive performance by minimizing friction during belt and pulley tooth intermeshing and by the circular distribution of the force. The direction of the power distribution changes with the running direction of the timing belt from the belt center towards the belt edges and vice versa.

TECHNOLOGY CHARACTERISTICS

The performance advantages of the ARC-POWER Technology is resulting in vibration reduced belt drives with increased power ratings along with increased noise reduction. The ARC-POWER Technology provides also a reduction of the polygonal effect adding to the smoothness of the belt drive (reduced oscillation).

Reliable “AT” Tooth Profile

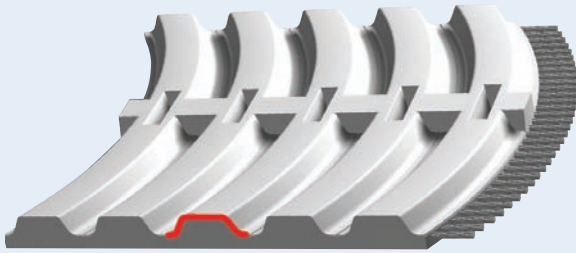

The high torque “AT” tooth profile meets the wide range of today’s demanding high-tech applications and provides increased tooth shear strength. The “AT” tooth profile also incorporates an enlarged running surface for outstanding drive performance.

Bi-Directional Self Tracking

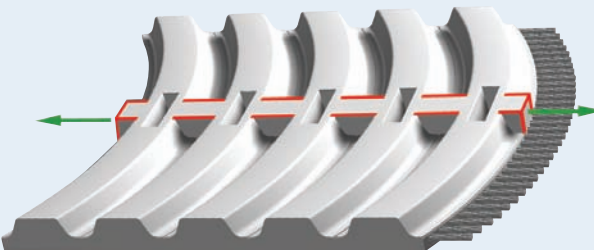

Due to its superior tooth structure, combined with the integrated tracking guide, the ARC-POWER Technology is truly self-tracking in both running directions. The tracking guide engages precisely with the centered pulley tracking groove. No pulley flanges are needed.

PERFORMANCE CHARACTERISTICS

Improved strength and power

Increased Power

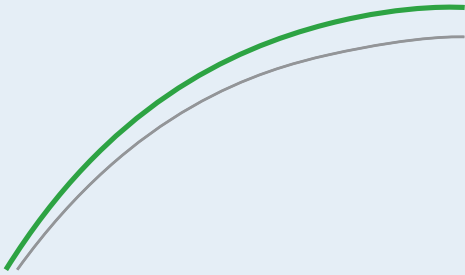

The ARC-POWER circular tooth design offers increased tooth shear strength of up to 10%. Sources of friction are minimized by the reduced polygonal effect, decreased tooth friction and the elimination of pulley flange interference.

Reduced polygon effect

Reduced Vibration

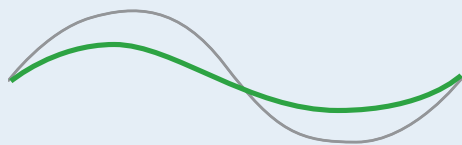

The polygonal effect in a timing belt drive induces belt oscillation. The ARC-POWER Technology substantially reduces vibration due to the unique belt and pulley tooth meshing at the point of tooth engagement.

Reduced friction

Reduced Noise Level

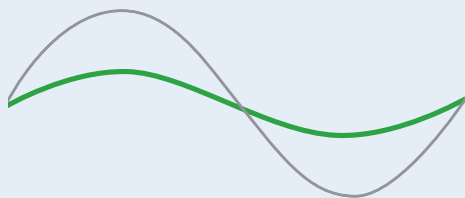

The "Arc" tooth design prevents "noise" created by friction and compressed air. The friction is reduced by the dynamics of the technology and air is vented towards the belt edges while belt and pulley teeth are meshing. ARC-POWER Technology further eliminates noise due to the absence of pulley flange friction.

PERFORMANCE CHARACTERISTICS

Built in safety

Higher Safety Factor

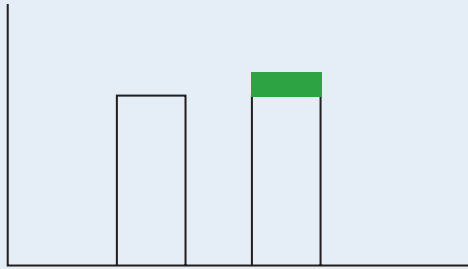

The unique design of the circular ARC-POWER tooth offers increased tooth shear strength adding approximately 10% more tooth shear safety compared to a conventional strait AT-Series belt tooth design with the same belt width.

Continuous tooth engagement

Uninterrupted Power Transfer

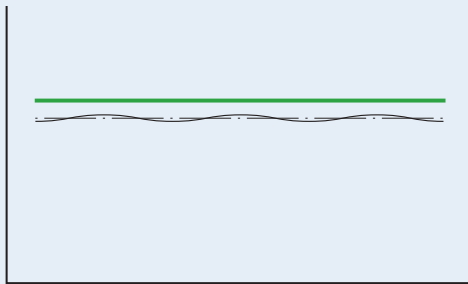

The ARC-POWER tooth design provides continuous tooth engagement with a constant minimum of 2 guiding teeth in mesh (tangential drive), improving the consistency of power transfer and the smoothness of the belt drive.

Vibration reduced tensioning

Smooth Idler Interaction

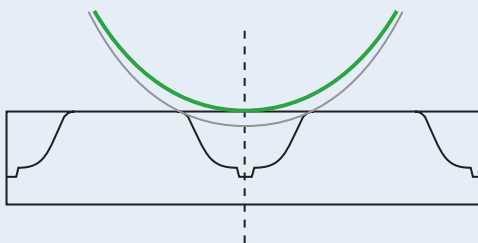

The circular ARC-POWER Technology permits quiet and vibration-free operation with flat idlers and tensioners running on the toothed side of the timing belt. The smooth running performance is based on the continuous tooth support providing an uninterrupted running surface eliminating belt bouncing.

ARC-POWER

BATK10

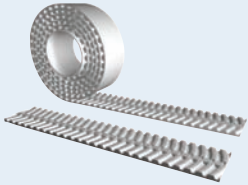
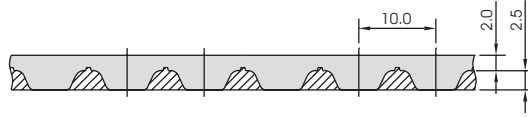

OPEN ENDED - M

Widths: 32 50 75 100 mm

Lengths: Any lengths available - Stock Rolls: 50 meters

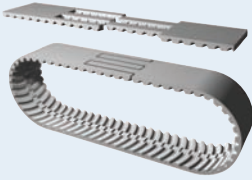

SPLICED AND WELDED ENDLESS - V

Widths: 32 50 75 100 mm

Lengths: Minimum joined Length: 880 mm

Length of timing belt can be specified in one tooth increments

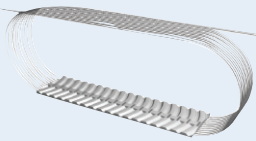

TRULY ENDLESS - BFX

Widths: 32 50 75 100 mm

Pitch/Length Version	Number of Teeth	Pitch/Length Version	Number of Teeth	Pitch/Length Version	Number of Teeth
BATK10 / 1100 BFX	110	BATK10 / 1700 BFX	170	BATK10 / 4000 BFX	400
BATK10 / 1150 BFX	115	BATK10 / 1800 BFX	180	BATK10 / 4500 BFX	450
BATK10 / 1210 BFX	121	BATK10 / 1900 BFX	190	BATK10 / 5000 BFX	500
BATK10 / 1240 BFX	124	BATK10 / 2000 BFX	200	BATK10 / 5600 BFX	560
BATK10 / 1250 BFX	125	BATK10 / 2240 BFX	224	BATK10 / 6000 BFX	600
BATK10 / 1320 BFX	132	BATK10 / 2500 BFX	250	BATK10 / 6700 BFX	670
BATK10 / 1400 BFX	140	BATK10 / 2800 BFX	280	BATK10 / 7100 BFX	710
BATK10 / 1500 BFX	150	BATK10 / 3000 BFX	300	BATK10 / 7500 BFX	750
BATK10 / 1600 BFX	160	BATK10 / 3550 BFX	355		

Further Lengths up to 20,000 mm available.

Length of belt can be increased in increments of one tooth from minimum length of 1,100 mm.

Ordering example: Polyurethane Timing Belt 50 BATK10 / 5000 BFX

Belt Width _____

Pitch _____

Length _____

Versions "M", "V" or "BFX" _____

NOTE: Options for NYLON facing see page 3

ARC-POWER

BATK15

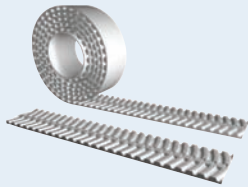
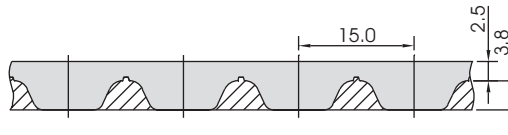

OPEN ENDED - M

Widths: 50 75 100 mm

Lengths: Any lengths available - Stock Rolls: 50 meters

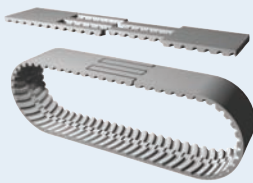

SPLICED AND WELDED ENDLESS - V

Widths: 50 75 100 mm

Lengths: Minimum joined Length: 1005 mm
Length of timing belt can be specified in one tooth increments

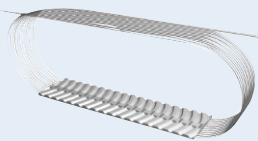

TRULY ENDLESS - BFX

Widths: 50 75 100 mm

Pitch/Length Version	Number of Teeth
BATK15 / 1500 BFX	100
BATK15 / 1590 BFX	106
BATK15 / 1710 BFX	114
BATK15 / 1800 BFX	120
BATK15 / 1905 BFX	127
BATK15 / 1995 BFX	133
BATK15 / 2250 BFX	150
BATK15 / 2505 BFX	167

Pitch/Length Version	Number of Teeth
BATK15 / 2790 BFX	186
BATK15 / 3000 BFX	200
BATK15 / 3495 BFX	233
BATK15 / 3750 BFX	250
BATK15 / 4005 BFX	267
BATK15 / 4500 BFX	300
BATK15 / 4995 BFX	333
BATK15 / 5295 BFX	353

Pitch/Length Version	Number of Teeth
BATK15 / 5595 BFX	373
BATK15 / 6000 BFX	400
BATK15 / 6300 BFX	420
BATK15 / 6705 BFX	447
BATK15 / 7095 BFX	473
BATK15 / 7500 BFX	500

Further Lengths up to 20,000 mm available.
Length of belt can be increased in increments of one tooth from minimum length of 1,500 mm.

Ordering example: Polyurethane Timing Belt 50 BATK15 / 6000 BFX

Belt Width _____

Pitch _____

Length _____

Versions "M", "V" or "BFX" _____

NOTE: Options for NYLON facing see page 3

SPECIFIC TOOTH SHEAR STRENGTH TABLE - BATK10

R.p.m. n (rpm)	F _{Uspez} (N/cm)	M _{spez} (Ncm/cm)	P _{spez} (W/cm)	R.p.m. n (rpm)	F _{Uspez} (N/cm)	M _{spez} (Ncm/cm)	P _{spez} (W/cm)
0	77.91	12.40	0.00	1600	46.00	7.32	12.26
20	76.74	12.22	0.26	1700	45.16	7.19	12.78
40	75.68	12.05	0.50	1800	44.31	7.05	13.29
60	74.73	11.88	0.75	1900	43.46	6.92	13.78
80	73.78	11.73	0.98	2000	42.72	6.81	14.25
100	72.82	11.60	1.21	2200	41.34	6.57	15.16
200	68.90	10.97	2.30	2400	40.07	6.37	16.01
300	65.83	10.47	3.29	2600	38.80	6.18	16.81
400	63.07	10.05	4.21	2800	37.63	6.00	17.57
500	60.84	9.68	5.07	3000	36.57	5.83	18.31
600	58.83	9.36	5.88	3200	35.62	5.67	19.00
700	56.92	9.06	6.65	3400	34.66	5.51	19.64
800	55.33	8.81	7.38	3600	33.81	5.37	20.26
900	53.85	8.56	8.08	3800	32.97	5.24	20.85
1000	52.47	8.35	8.75	4000	32.12	5.11	21.41
1100	51.20	8.15	9.39	4500	30.53	4.81	22.68
1200	50.03	7.96	10.01	5000	28.51	4.55	23.85
1300	48.97	7.79	10.60	5500	27.03	4.30	24.80
1400	47.91	7.62	11.17	6000	25.65	4.08	25.65
1500	46.96	7.46	11.73	6500	24.38	3.87	26.39

SPECIFIC TOOTH SHEAR STRENGTH TABLE - BATK15

R.p.m. n (rpm)	F _{Uspez} (N/cm)	M _{spez} (Ncm/cm)	P _{spez} (W/cm)	R.p.m. n (rpm)	F _{Uspez} (N/cm)	M _{spez} (Ncm/cm)	P _{spez} (W/cm)
0	116.87	31.01	0.00	1600	63.76	16.12	27.03
20	116.87	30.44	0.64	1700	62.17	15.73	28.02
40	114.80	29.93	1.25	1800	60.74	15.35	28.95
60	112.94	29.43	1.86	1900	59.57	15.02	29.84
80	111.19	28.98	2.43	2000	58.51	14.64	30.70
100	110.13	28.54	2.99	2200	56.71	13.99	32.28
200	105.42	26.69	5.60	2400	54.38	13.42	33.72
300	101.12	25.22	7.93	2600	52.21	12.85	35.03
400	95.72	24.00	10.05	2800	50.14	12.38	36.22
500	91.11	22.92	12.00	3000	48.55	11.87	37.30
600	87.24	22.02	13.81	3200	46.43	11.43	38.27
700	83.79	21.18	15.51	3400	44.79	10.97	39.14
800	80.93	20.42	17.09	3600	43.20	10.59	39.91
900	77.91	19.71	18.58	3800	41.71	10.20	40.60
1000	75.42	19.07	19.99	4000	40.81	9.82	41.21
1100	73.09	18.50	21.33	4500	38.96	8.98	42.38
1200	70.97	17.98	22.59	5000	37.58	8.22	43.12
1300	68.95	17.47	23.79	5500	36.20	7.27	43.96
1400	67.15	17.01	24.92	6000	34.93	6.51	44.86
1500	65.40	16.56	26.00	6500	33.66	5.55	45.59

CALCULATION - TOOTH SHEAR STRENGTH

Belt width b

$$b = \frac{F_U}{z_e \cdot F_{U\text{spez}}} \quad \text{cm}$$

$$b = \frac{100 \cdot M}{z_1 \cdot z_e \cdot M_{\text{spez}}} \quad \text{cm}$$

$$b = \frac{1000 \cdot P}{z_1 \cdot z_e \cdot P_{\text{spez}}} \quad \text{cm}$$

Load ratings

$$F_U = F_{U\text{spez}} \cdot z_e \cdot b \quad \text{N}$$

$$M = \frac{M_{\text{spez}} \cdot z_1 \cdot z_e \cdot b}{100} \quad \text{Nm}$$

$$P = \frac{P_{\text{spez}} \cdot z_1 \cdot z_e \cdot b}{1000} \quad \text{kW}$$

Number of teeth in mesh

$$z_{e\text{max}} = 12 \quad (\text{BFX and Open Ended Belts})$$

$$z_{e\text{max}} = 6 \quad (\text{Welded Belts})$$

$$z_e = \frac{z_1}{180} \cdot \arccos \frac{t \cdot (z_2 - z_1)}{2\pi \cdot a}$$

- b - belt width in cm
- $F_{U\text{spez}}$ - Specific peripheral force in N/cm
- M_{spez} - Specific torque in Ncm/cm
- P_{spez} - Specific power in W/cm
- z_1 - No. of teeth on the small pulley
- z_2 - No. of teeth on the large pulley
- z_e - No. of teeth in mesh
- t - pitch in mm
- a - center distance in mm

NOTE: Values see page 10-11

PERFORMANCE PARAMETERS

BATK10 Open Ended (M) and Welded (V)



Type	Tension-Member	Belt Width (mm)				Dimension
		32	50	75	100	
BRECO M	F_{all} (steel cord)	5000	7500	12000	17000	F_{all} (N)
BRECO V	F_{all} (steel cord)	2500	3750	6000	8500	F_{all} (N)
spec. spring rate	(steel cord)	1370000	2120000	3180000	4250000	(N)
BRECO M	F_{all} (stainless steel cord)	4000	6000	9000	12000	F_{all} (N)
BRECO V	F_{all} (stainless steel cord)	2000	3000	4500	6000	F_{all} (N)
spec. spring rate	(stainless steel cord)	990000	1530000	2300000	3060000	(N)
Belt weight (approx.)	BATK10	0.192	0.300	0.450	0.600	(kg/m)

PERFORMANCE PARAMETERS

BATK10 Truly Endless (BFX)



Type	Tension-Member	Belt Width (mm)				Dimension
		32	50	75	100	
BFX	F _{call} (steel cord)	4750	7750	12000	16000	F _{call} (N)
BFX	F _{call} (stainless steel cord)	3400	5600	8650	11200	F _{call} (N)
Belt weight (approx.)	BATK10	0.192	0.300	0.450	0.600	(kg/m)

BATK15 Open Ended (M) and Welded (V)



Type	Tension-Member	Belt Width (mm)			Dimension
		50	75	100	
BRECO M	F _{call} (steel cord)	11200	16800	22400	F _{call} (N)
BRECO V	F _{call} (steel cord)	5600	8400	11200	F _{call} (N)
spec. spring rate	(steel cord)	2800000	4200000	5600000	(N)
BRECO M	F _{call} (stainless steel cord)	9000	13500	18000	F _{call} (N)
BRECO V	F _{call} (stainless steel cord)	4500	6750	9000	F _{call} (N)
spec. spring rate	(stainless steel cord)	2800000	4200000	5600000	(N)
Belt weight (approx.)	BATK15	0.428	0.642	0.856	(kg/m)

BATK15 Truly Endless (BFX)

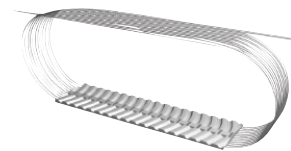

Type	Tension-Member	Belt Width (mm)			Dimension
		50	75	100	
BFX	F _{call} (steel cord)	10400	16000	21600	F _{call} (N)
BFX	F _{call} (hi-flex cord)	10400	16000	21600	F _{call} (N)
BFX	F _{call} (stainless steel cord)	8300	12800	17300	F _{call} (N)
Belt weight (approx.)	BATK15	0.420	0.629	0.836	(kg/m)

ALUMINUM PULLEYS

BATK10

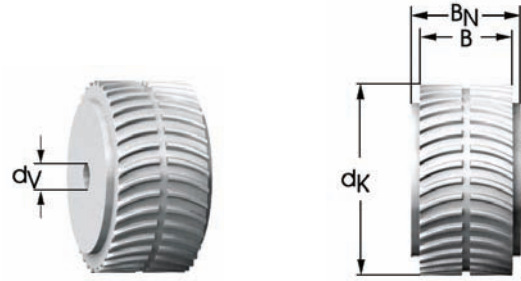

Tooth Type	Number of Teeth	Outside Diameter	Pitch Diameter	Root Diameter	Face Width	Width w/2 Hubs	Pilot Bore	Part Number
BATK10	z	d _k (mm)	d ₀ (mm)	d _r (mm)	B (mm)	B _N (mm)	d _v (mm)	
BELT WIDTH = 32 mm	20	61.84	63.84	57.14	37	47	12H7	AL 47 BATK10 / 20 hub 46x5
	24	74.57	76.57	69.87	37	47	12H7	AL 47 BATK10 / 24 hub 57x5
	25	77.76	79.76	73.06	37	47	12H7	AL 47 BATK10 / 25 hub 59x5
	27	84.12	86.12	79.42	37	47	12H7	AL 47 BATK10 / 27 hub 64x5
	30	93.67	95.67	88.97	37	47	12H7	AL 47 BATK10 / 30 hub 73x5
	32	100.04	102.04	95.34	37	47	12H7	AL 47 BATK10 / 32 hub 80x5
	36	112.77	114.77	108.07	37	47	16H7	AL 47 BATK10 / 36 hub 92x5
	40	125.50	127.50	120.80	37	47	16H7	AL 47 BATK10 / 40 hub 105x5
	48	150.97	152.97	146.27	37	47	20H7	AL 47 BATK10 / 48 hub 130x5
60	189.17	191.17	184.47	37	47	20H7	AL 47 BATK10 / 60 hub 169x5	
BELT WIDTH = 50 mm	20	61.84	63.84	57.14	55	65	12H7	AL 65 BATK10 / 20 hub 46x5
	24	74.57	76.57	69.87	55	65	12H7	AL 65 BATK10 / 24 hub 57x5
	25	77.76	79.76	73.06	55	65	12H7	AL 65 BATK10 / 25 hub 59x5
	27	84.12	86.12	79.42	55	65	12H7	AL 65 BATK10 / 27 hub 64x5
	30	93.67	95.67	88.97	55	65	12H7	AL 65 BATK10 / 30 hub 73x5
	32	100.04	102.04	95.34	55	65	12H7	AL 65 BATK10 / 32 hub 80x5
	36	112.77	114.77	108.07	55	65	16H7	AL 65 BATK10 / 36 hub 92x5
	40	125.50	127.50	120.80	55	65	16H7	AL 65 BATK10 / 40 hub 105x5
	48	150.97	152.97	146.27	55	65	20H7	AL 65 BATK10 / 48 hub 130x5
60	189.17	191.17	184.47	55	65	20H7	AL 65 BATK10 / 60 hub 169x5	
BELT WIDTH = 75 mm	20	61.84	63.84	57.14	80	90	12H7	AL 90 BATK10 / 20 hub 46x5
	24	74.57	76.57	69.87	80	90	12H7	AL 90 BATK10 / 24 hub 57x5
	25	77.76	79.76	73.06	80	90	12H7	AL 90 BATK10 / 25 hub 59x5
	27	84.12	86.12	79.42	80	90	12H7	AL 90 BATK10 / 27 hub 64x5
	30	93.67	95.67	88.97	80	90	12H7	AL 90 BATK10 / 30 hub 73x5
	32	100.04	102.04	95.34	80	90	12H7	AL 90 BATK10 / 32 hub 80x5
	36	112.77	114.77	108.07	80	90	16H7	AL 90 BATK10 / 36 hub 92x5
	40	125.50	127.50	120.80	80	90	16H7	AL 90 BATK10 / 40 hub 105x5
	48	150.97	152.97	146.27	80	90	20H7	AL 90 BATK10 / 48 hub 130x5
60	189.17	191.17	184.47	80	90	20H7	AL 90 BATK10 / 60 hub 169x5	

Stock items are indicated by bold type. Other pulley sizes, pulley materials, or custom pulleys on request. Please contact BRECOflex-Engineering for further information.

NOTE: All pulleys must have same running direction! (To be considered with pulley modifications, i.e. hubs, counterbores, etc.)

BRECOflex CO., L.L.C. Toll Free: 1-888-463-1400 • Fax: 732-542-6725 • Website: www.brecoflex.com

ALUMINUM PULLEYS

BATK10

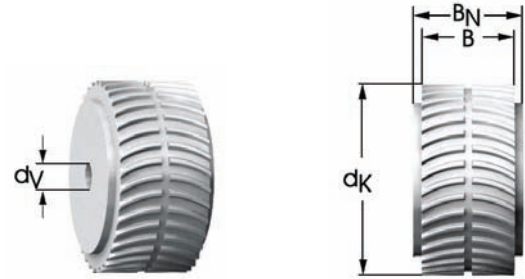

Tooth Type	Number of Teeth	Outside Diameter	Pitch Diameter	Root Diameter	Face Width	Width w/2 Hubs	Pilot Bore	Part Number
BATK10	z	d _k (mm)	d ₀ (mm)	d _r (mm)	B (mm)	B _N (mm)	d _v (mm)	
BELT WIDTH = 100 mm	20	61.84	63.84	57.14	105	115	12H7	AL 115 BATK10 / 20 hub 46x5
	24	74.57	76.57	69.87	105	115	12H7	AL 115 BATK10 / 24 hub 57x5
	25	77.76	79.76	73.06	105	115	12H7	AL 115 BATK10 / 25 hub 59x5
	27	84.12	86.12	79.42	105	115	12H7	AL 115 BATK10 / 27 hub 64x5
	30	93.67	95.67	88.97	105	115	12H7	AL 115 BATK10 / 30 hub 73x5
	32	100.04	102.04	95.34	105	115	12H7	AL 115 BATK10 / 32 hub 80x5
	36	112.77	114.77	108.07	105	115	16H7	AL 115 BATK10 / 36 hub 92x5
	40	125.50	127.50	120.80	105	115	16H7	AL 115 BATK10 / 40 hub 105x5
	48	150.97	152.97	146.27	105	115	20H7	AL 115 BATK10 / 48 hub 130x5
	60	189.17	191.17	184.47	105	115	20H7	AL 115 BAKT10 / 60 hub 169x5

Flexibility BATK10 (Minimum number of teeth, minimum diameter)

Drive Type			Steel Cord		Stainless Steel Cord	
			M / BFX	V	M / BFX	V
 z _{min} d _{min}	without back bending	z _{min}	20	25	25	25
		d _{min} (mm)	60	80	80	80
 z _{min} d _{min}	with back bending	z _{min}	25	25	40	40
		d _{min} (mm)	120	120	130	130

Stock items are indicated by bold type. Other pulley sizes, pulley materials, or custom pulleys on request. Please contact BRECOflex-Engineering for further information.

Ordering example: Aluminum Pulleys AL 65 BATK10 / 25 hub 59x5 dv=12H7

Aluminum Pulley _____

Width over 2 Hubs _____

Type/Pitch _____

Number of Teeth _____

Hub Dimensions _____

Pilot Bore _____

ALUMINUM PULLEYS

BATK15

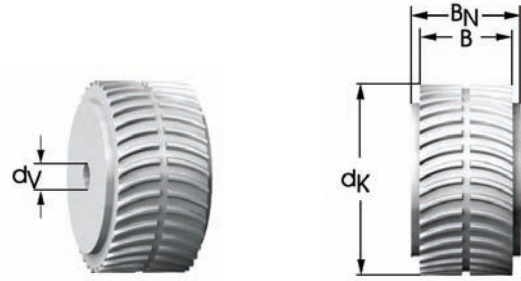

Tooth Type	Number of Teeth	Outside Diameter	Pitch Diameter	Root Diameter	Face Width	Width w/2 Hubs	Pilot Bore	Part Number
BATK15	z	d _k (mm)	d ₀ (mm)	d _r (mm)	B (mm)	B _N (mm)	d _v (mm)	
BELT WIDTH = 50 mm	20	93.01	95.71	85.91	55	75	12H7	AL 75 BATK15/ 20 hub 46x10
	24	112.11	114.81	105.01	55	75	12H7	AL 75 BATK15/ 24 hub 58x10
	25	116.89	119.58	109.79	55	75	12H7	AL 75 BATK15/ 25 hub 58x10
	27	126.44	129.13	119.34	55	75	12H7	AL 75 BATK15/ 27 hub 58x10
	30	140.76	143.46	133.66	55	75	12H7	AL 75 BATK15/ 30 hub 60x10
	32	150.31	153.01	143.21	55	75	12H7	AL 75 BATK15/ 32 hub 65x10
	36	169.41	172.10	162.31	55	75	16H7	AL 75 BATK15/ 36 hub 70x10
	40	188.51	191.20	181.41	55	75	16H7	AL 75 BATK15/ 40 hub 80x10
	48	226.70	229.40	219.60	55	75	16H7	AL 75 BATK15/ 48 hub 140x10
60	284.00	286.70	276.90	55	75	16H7	AL 75 BATK15/ 60 hub 160x10	
BELT WIDTH = 75 mm	20	93.01	95.71	85.91	80	100	12H7	AL 100 BATK15/ 20 hub 46x10
	24	112.11	114.81	105.01	80	100	12H7	AL 100 BATK15/ 24 hub 58x10
	25	116.89	119.58	109.79	80	100	12H7	AL 100 BATK15/ 25 hub 58x10
	27	126.44	129.13	119.34	80	100	12H7	AL 100 BATK15/ 27 hub 58x10
	30	140.76	143.46	133.66	80	100	12H7	AL 100 BATK15/ 30 hub 60x10
	32	150.31	153.01	143.21	80	100	12H7	AL 100 BATK15/ 32 hub 65x10
	36	169.41	172.10	162.31	80	100	16H7	AL 100 BATK15/ 36 hub 70x10
	40	188.51	191.20	181.41	80	100	16H7	AL 100 BATK15/ 40 hub 80x10
	48	226.70	229.40	219.60	80	100	16H7	AL 100 BATK15/ 48 hub 140x10
60	284.00	286.70	276.90	80	100	16H7	AL 100 BATK15/ 60 hub 160x10	
BELT WIDTH = 100 mm	20	93.01	95.71	85.91	105	125	12H7	AL 125 BATK15/ 20 hub 46x10
	24	112.11	114.81	105.01	105	125	12H7	AL 125 BATK15/ 24 hub 58x10
	25	116.89	119.58	109.79	105	125	12H7	AL 125 BATK15/ 25 hub 58x10
	27	126.44	129.13	119.34	105	125	12H7	AL 125 BATK15/ 27 hub 58x10
	30	140.76	143.46	133.66	105	125	12H7	AL 125 BATK15/ 30 hub 60x10
	32	150.31	153.01	143.21	105	125	12H7	AL 125 BATK15/ 32 hub 65x10
	36	169.41	172.10	162.31	105	125	16H7	AL 125 BATK15/ 36 hub 70x10
	40	188.51	191.20	181.41	105	125	16H7	AL 125 BATK15/ 40 hub 80x10
	48	226.70	229.40	219.60	105	125	16H7	AL 125 BATK15/ 48 hub 140x10
60	284.00	286.70	276.90	105	125	16H7	AL 125 BATK15/ 60 hub 160x10	

Other pulley sizes, pulley materials, or custom pulleys on request. Please contact BRECOflex-Engineering for further information.

NOTE: All pulleys must have same running direction! (To be considered with pulley modifications, i.e. hubs, counterbores, etc.)

Flexibility BATK15 (Minimum number of teeth, minimum diameter)

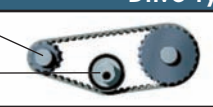
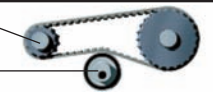
Drive Type			Steel Cord		Stainless Steel Cord	
			M / BFX	V	M / BFX	V
 z_{min} d_{min}	without back bending	z_{min}	20	25	25	25
		d_{min} (mm)	100	120	120	120
 z_{min} d_{min}	with back bending	z_{min}	30	35	35	40
		d_{min} (mm)	150	180	180	190

Clamps and Tensioners

For clamps and tensioning clamps, please contact BRECOflex-Engineering.

Clamps



Without Mounting Holes



With Mounting Holes

Tensioning Clamps

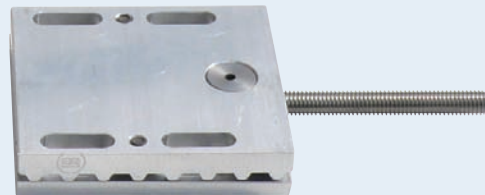

With Slotted Mounting Holes

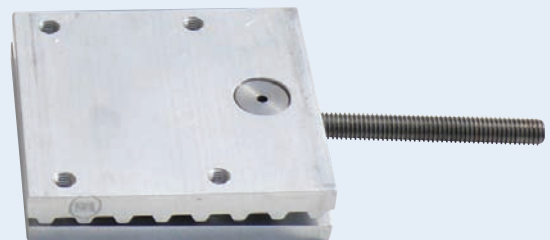

With Mounting Holes

Ordering example: Aluminum Pulleys AL 75 BATK15 / 27 hub 58x10 dv=12H7

Aluminum Pulley _____
 Width over 2 Hubs _____
 Type/Pitch _____
 Number of Teeth _____
 Hub Dimensions _____
 Pilot Bore _____

TIMING BELT STANDARDS DEFINED

	Standard	Cold Flexible	FDA Conforming	
Material Combinations	TPU-ST1 ¹⁾ steel cord	TPU-KF1 steel cord	TPU-FDA1 ²⁾ stainless steel cord	TPU-AU1 ²⁾ stainless steel cord
Products	all belt types, BFX-belts > 720mm, profiles	all belt types, BFX-belts > 720mm, profiles	all belt types, all BFX-belt sizes, profiles	all belt types, BFX-belts > 720mm, profiles
Color	white (special colors available)	transparent	transparent	transparent
Hardness	92 Shore A	85 Shore A	92 Shore A	92 Shore A
Temperature Range	0°C to +80°C (+32°F to +176°F)	-25°C to +5°C (-13°F to +41°F)	0°C to +80°C (+32°F to +176°F)	0°C to +50°C (+32°F to +122°F)
Comment	great performance characteristics, suitable for most applications, standard material with steel cord	reduced strength during cold start up, high resistance to hydrolysis and bacteria	suitable for <u>intermittent</u> cleaning with diluted cleaning agents, meets FDA-Regulations	suitable for <u>continuous</u> cleaning with diluted cleaning agents, meets FDA-Regulations

¹⁾ TPU-ST1 with hi-flex tension member available

²⁾ Stainless steel cord in BRECOFLEX timing belts over 7500 mm on request

BRECOflex PRODUCT CATALOGS



Polyurethane Timing Belts

Main Catalog (184 pages)
Metric and English Pitches.

See BRECOflex catalog # B212

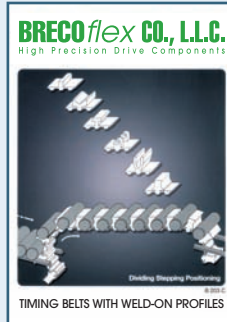

Polyurethane Timing Belts with Weld-on Profiles

Dividing, Stepping, Positioning.

See BRECOflex catalog # B203



Calculations Driving, Positioning, Conveying

Power, Torque, and Peripheral Force calculations.

See BRECOflex catalog # B204

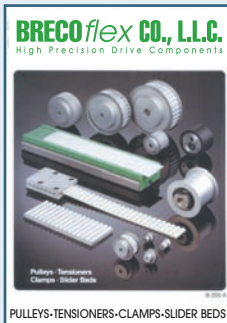

Accessory Items for Polyurethane Timing Belts

Pulleys, Tensioners, Clamps, Slider Beds.

See BRECOflex catalog # B205

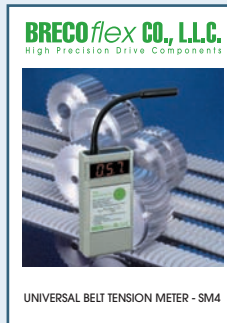

Tension Meter

Improve performance, lifetime, positioning accuracy, bearing load, and noise level.

See BRECOflex catalog # B207

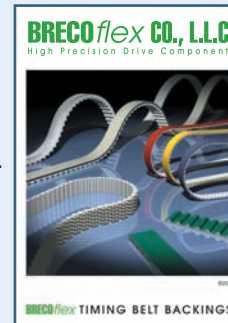

Timing Belt Backings

Polyurethane Timing Belts in Metric and English pitches with a wide range of cover materials.

See BRECOflex catalog # B208

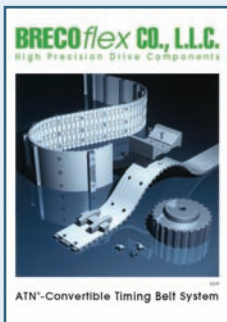

ATN® - Convertible Timing Belt System

ATN technology allows the reconfiguration of profiled timing belts at the customer site.

See BRECOflex catalog # B209



ESBAND Truly Endless Woven Flat Belts

Wide variety of Polyurethane, Neoprene and Silicone state-of-the-art flat belts.

See BRECOflex catalog # B210



Pulleys for Polyurethane and Neoprene Timing Belts

Finished pulleys and stock pulley program.

See BRECOflex catalog # B216

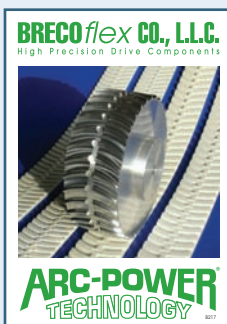

ARC-POWER Technology

Circular "ARC" tooth shape.

See BRECOflex catalog # B217

All recommendations for the use of the products described herein and all other data or information set forth in this publication, whether concerning such products or otherwise, are furnished without any guarantee, warranty representations or inducement of any kind whether expressed or implied, including but not limited to warranties of merchantability and fitness for a particular purpose. BRECOflex CO., L.L.C. expressly disclaims liability under any theory, including without limitation, contract negligence, misrepresentation or breach of any obligation relating to the recommendation, data or information set forth herein. Readers and customers are encouraged to conduct their own test before using any product. Read its label and all related instructions.

BRECOflex CO., L.L.C. reserves the right to make changes in the technical and dimensional specifications of its products without prior notice. Responsibility for expenses incurred as a result of product changes or discontinuance of a product lies solely with the purchaser.

BRECO *flex* CO., L.L.C.

High Precision Drive Components



Printed in USA 06/08

BRECO *flex* CO., L.L.C.

High Precision Drive Components

PO Box 829 • 222 Industrial Way West • Eatontown, NJ 07724
Toll Free: 1-888-463-1400 • Tel: 732-460-9500 • Fax: 732-542-6725
www.brecoflex.com • e-mail: info@brecoflex.com

Copyright 2008 BRECO *flex* CO., L.L.C. • BRECO®, BRECOFLEX® & BATK10® are registered trademarks of BRECO Antriebstechnik GmbH.
ARC-POWER® is a registered trademark of BRECO *flex* CO., L.L.C. Patents pending. Specifications are subject to change without prior notice.