

# BRECO *flex* CO., L.L.C.

High Precision Drive Components

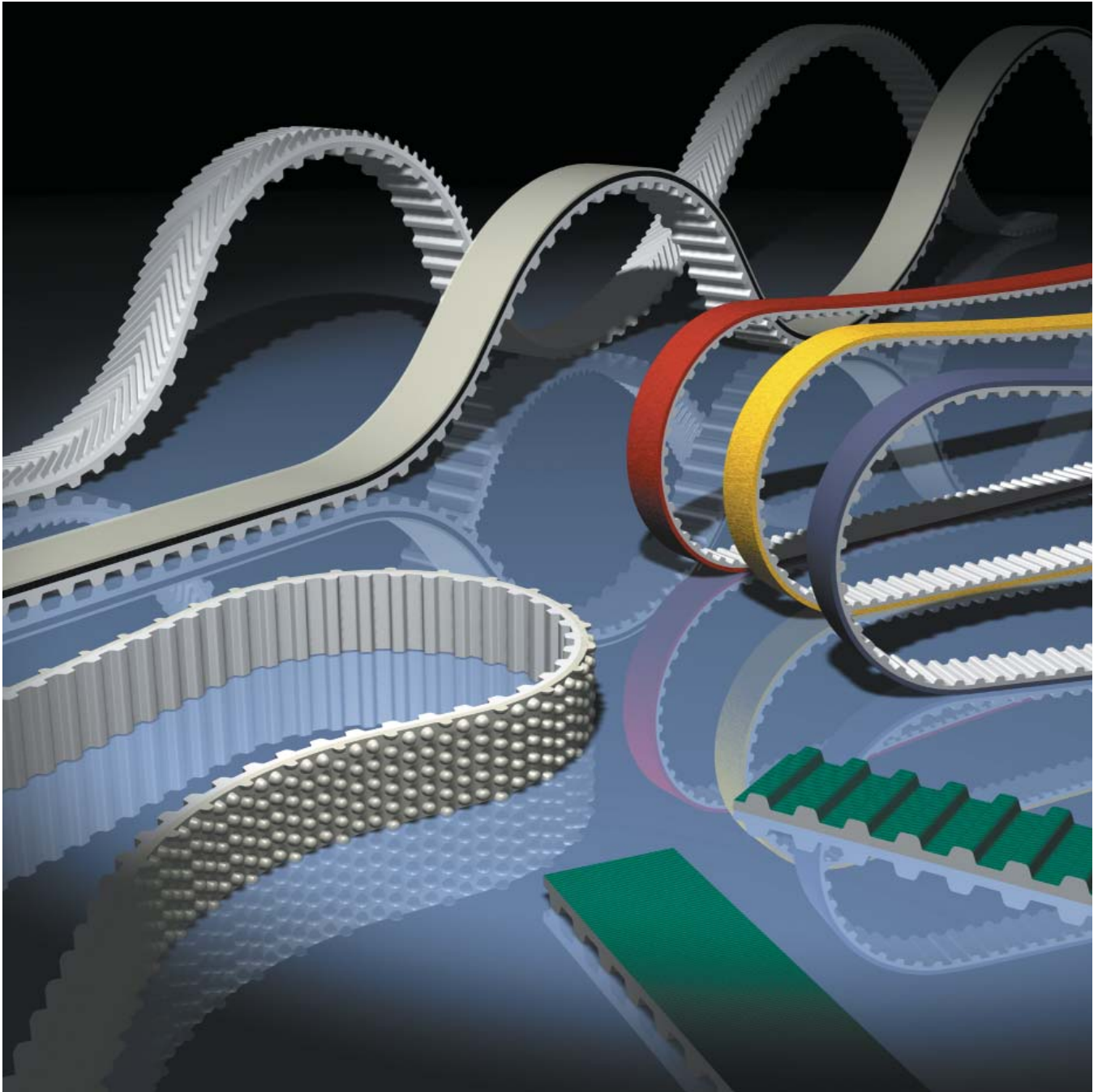

B208

**BRECO *flex* TIMING BELT BACKINGS**

# SUPERIOR TIMING BELT BACKINGS

## BRECOflex COVERS ALL

The world leader in the polyurethane timing belt industry is setting new standards with state-of-the-art products. BRECOflex CO., L.L.C. offers scientifically engineered, covered timing belts, manufactured for undeviating quality. It is BRECOflex's mission to provide customers with outstanding products and immediate, professional, technical support to meet their diverse needs. BRECOflex has developed many patented processes for producing sophisticated, high precision timing belts in the widest product range. Worldwide, more OEMs specify BRECOflex timing belts and drive components than any other brand.

BRECOflex offers an extensive selection of cover materials which are bonded to the timing belts. Superior know-how and state-of-the-art processes prevent the cover from delaminating. The selection of the most appropriate and best performing backing material always depends on the specific applications and function requirements.

Our unsurpassed backing processes allow us to cover virtually any polyurethane timing belt. Innovative technology allows BRECOflex to provide covered timing belts in virtually any length. Customized backing applications are a specialty of BRECOflex. Cost effective manufacturing techniques allow BRECOflex to offer both prototype and production quantities. BRECOflex goes the extra mile by offering FREE engineering support to meet customer application needs and expectations.

## BRECOflex ADVANTAGES

- Single source manufacturer
- Largest selection of polyurethane timing belts
- Backing expertise
- Superior bonding agents
- High precision manufacturing
- Cutting edge technology
- Custom machining
- Prototype and production quantities
- Innovative backing solutions
- Extensive range of backing materials
- Short turn around time

# SUPERIOR TIMING BELT BACKINGS

## BRECOflex BACKING CHARACTERISTICS

-For technical details, see backing specifications on page 6

1. **Linatex**



This natural rubber backing has good tear resilience and excellent cut resistance. The high coefficient of friction makes this backing extremely versatile in general conveying applications. It can be offered in endless form when there are concerns about splice delamination.

2. **Supergrip**



Supergrip offers a high coefficient of friction, good resilience and high wear resistance. This backing is good for diagonal and inclined conveying applications and is available in blue or green.

3. **T-cover/  
PU-385 series**



Solid polyurethane composition makes our T-cover and PU-385 series backings superlative to wear and abrasion resistance. The PU-385 series backings are also available in waffle - WM, nub - NP and herringbone - FG profiles. These are excellent products for machining.

4. **PU Yellow**



High density closed polyurethane foam offers good abrasion and wear resistance. This highly machinable backing material can be customized for unlimited applications. It is ideal for heavy-duty, vacuum and paper product transfer applications.

5. **PVC Blue**

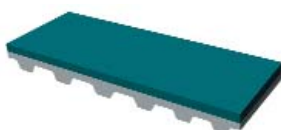

PVC offers increased friction and good wear resistance for no-slip conveying. This backing is great for wood, cardboard and sheet metal transfer applications.

6. **Correx Gum**

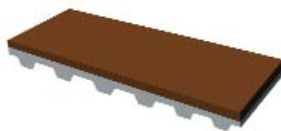

This filled natural rubber backing combines the advantages of a high coefficient of friction and good wear resistance. This backing is machinable for pockets and nest applications and can be used for general conveying purposes.

7. **Porol**



Low-density, open cell polyurethane foam backing is optimal for conveying sensitive, fragile parts.

8. **Celloflex**



Medium density, micro-cellular polyurethane foam backing has good flexibility and damping characteristics and is ideal for conveying fragile parts. This backing is an excellent choice for delicate textile, film and packaging applications.

9. **White Nub**



PVC offers increased friction, good resilience and wear resistance. This backing also has good chemical resistance and is used for point contact applications.

# SUPERIOR TIMING BELT BACKINGS

## BRECOflex BACKING CHARACTERISTICS

-For technical details, see backing specifications on page 6

10. **D15**



Polyurethane composition makes D15 backings resistant to wear and abrasion. This backing is ideal for wood, glass, and sheet metal applications.

11. **Linatrilite**

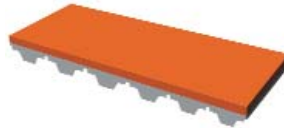

This vulcanized nitrile backing has good abrasion resistance. A high coefficient of friction and broad heat capacity make this material extremely versatile in haul-off and laminate applications.

12. **RP 400**

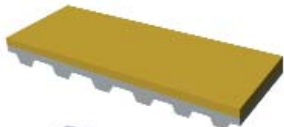

A rubber backing with very high wear resistance is suitable for wood, glass and steel applications.

13. **Chromleder**



This leather backing has good friction and abrasion tolerance. It is mostly used in the conveying of oily or greasy parts. Its resistance to simple oils and greases makes this a good choice for haul-off applications.

14. **TT 60**



This polyester fleeced backing is inherently anti-static and capable of high temperature surface contact. This is a good choice for hot glass, wafer and PC board transfer applications.

15. **NBR 65**



NBR rubber has good oil, fuel, solvent, acid and lye resistance. This backing can be used in a wide array of harsh conveying applications.

16. **Mini-Grip**



This PVC based backing offers a high coefficient of friction, good resilience and high wear resistance. It is excellent for transportation of wet and contoured parts.

17. **PVC White**



This FDA approved backing material offers good resistance to acids, bases, and salts. It is ideal for the food, film processing and pharmaceutical industries.

18. **PVC White-Herringbone**



This FDA approved backing material offers good resistance to acids, bases and salts. It offers a unique line contact and is ideal for food, film processing and pharmaceutical industries.

# SUPERIOR TIMING BELT BACKINGS

## BRECOflex BACKING CHARACTERISTICS

-For technical details, see backing specifications on page 6

19. **PAR**

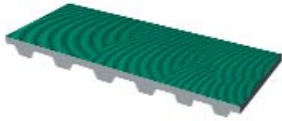

Nylon facing on belt back offers reduced coefficient of friction and is resistant to oils and greases under most conditions. This facing is good for accumulator conveyor applications.

20. **PAZ**



Nylon facing on tooth side offers reduced coefficient of friction and is resistant to oils and greases under most conditions. This facing provides optimal belt and pulley interaction and reduces noise and vibration. Nylon facing achieves improved performance when used with metal supports.

21. **PAR-PAZ**

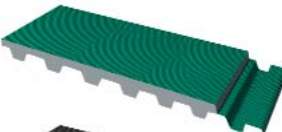

Nylon facings on belt back and tooth side combine all of the advantages mentioned above.

22. **PAR-PAZ,  
Anti-Static**



Nylon faced timing belts can be offered with black anti-static coating. For details, contact Applications Engineering.

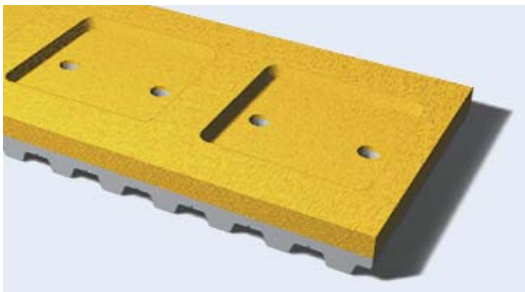

## CUSTOM MACHINED BACKINGS

Certain backings allow for special machining and processing to provide for synchronous conveying and positioning of goods. Pockets, contours, slots, holes, etc. can be precisely machined for each requirement. Please contact Applications Engineering for assistance.



## REDUCED STRESS CONCENTRATION

Covered timing belts have reduced bending ability. Therefore, larger diameter pulleys and idlers must be used in order to reduce stress concentration (see page 9, Bending Ability). The bending flexibility can be increased up to 30% by properly placing stress reliefs in the backing material.

# BACKING SPECIFICATIONS

	BACKING TYPE	BACKING MATERIAL	COLOR	HARDNESS (SHORE A) DENSITY (g/dm <sup>3</sup> )	COEFFICIENT OF FRICTION (μ) (STATIC - AL)	THICKNESS (mm)	TEMPERATURE RANGE (°C)	RESISTIVITY	APPLICATIONS	CHARACTERISTICS	BENDING ABILITY
1	Linatex	Natural Rubber	Red	35	1.1	1.6-20	-40 70	Simple fats oils & wet abrasion	Glass industry extruders & conveyers	High friction, high strain & abrasion resistance	F
2	Supergrip	PVC	Blue Green	30	0.8 0.6	4	-15 90	Simple fats & oils - green only	Diagonal, incline & rising	High friction & wear resistance	MF
3	T-cover PUR 385 WM 385 NP 385 FG 385	Polyurethane	Transparent	85	0.7 0.7 0.4 0.3 0.5	1.5-6 3-6 5 4 4	-20 50	Simple fats & oils	Conveying of abrasive parts	Highest wear resistance	S
4	PU Yellow	Polyurethane - foam	Yellow	55	0.6	2-10	-10 60	Simple fats & oils	Vacuum & paper applications	Good wear resistance	SF
5	PVC Blue	PVC	Blue	40	1.0	1	-15 90	Simple fats & oils, acids, salts, bases	Paper & wood conveying	High coefficient of friction	F
6	Correx Gum	Natural Rubber	Brown	40	0.9	6/10	-50 70	Limited oil & fat resistance	General conveying	High coefficient of friction & wear resistance	SF
7	Porol	Cellular Polyurethane	Black	190 g/dm <sup>3</sup>	0.8	3/5/10	-40 70	Limited oil & fat resistance	Conveying of delicate parts	Soft foam quality	F
8	Celloflex	Microcellular Polyurethane	Beige	350 g/dm <sup>3</sup>	0.3	2/3/5	-30 80	Simple fats & oils	Conveying of delicate parts	High flexibility	MF
9	White Nub	PVC	White	55	0.6	1.65	-20 80	Simple fats & oils	General conveying	Point contact	F
10	D15	Polyurethane	Natural Green Blue	70	0.8	1-5	-20 80	Simple fats & oils	Conveying of abrasive parts	High wear resistance	SF
11	Linatrite	Nitrile	Orange	55	1.0	3/5/6	-20 110	Simple fats & oils	Chemical & oil contact conveying	High friction, high strain and wear resistance	F
12	RP 400	Rubber	Yellow	35	1.0	2-6	-10 80	Limited oil & fat resistance	General conveying	High friction, high strain and wear resistance	F
13	Chrom- leder	Leather	Grey	—	0.4	2/3	0 60	Simple fats & oils	Conveying of oily, greasy parts	Leather top coat	SF
14	TT 60	Polyester Fleece	Charcoal	—	0.2	2	-10 120	Simple fats & oils	Wafer and glass conveying	Anti-Static	SF
15	NBR 65	Nitrile	Black	65	0.6	1.5	-20 70	Simple fats & oils	Chemical & oil contact conveying	Good chemical resistance	SF
16	Mini-Grip	PVC	Blue Green	30	0.6 0.4	1	-10 110	Simple fats & oils	Diagonal/ inclined conveying	High friction and wear resistance	F
17	PVC White	PVC	White	40	1.1	2	-15 90	Acids, salts & bases	Food & pharmaceutical industries	FDA approval for surface contact with foods	MF
18	PVC White Herring- bone	PVC	White	40	0.7	4	-10 110	Simple fats & oils	Food & pharmaceutical industries	FDA approval for surface contact with foods	SF
19	PAR	Nylon	Green	—	0.2	—	-20 80	Simple fats & oils	Power transmission conveying/accumulating	High performance & reduced friction	F
20	PAZ	Nylon	Green	—	0.2	—	-20 80	Simple fats & oils	Power transmission conveying	High performance & reduced friction	F
21	PAR/PAZ	Nylon	Green	—	0.2	—	-20 80	Simple fats & oils	Power transmission conveying	High performance & reduced friction	F
22	PAR/PAZ Anti-Static	Nylon	Black	—	0.2	—	-20 80	Simple fats & oils	Conveying	Anti-static	F

# SUPERIOR TIMING BELT BACKINGS

## BRECOflex PRODUCT CATALOGS

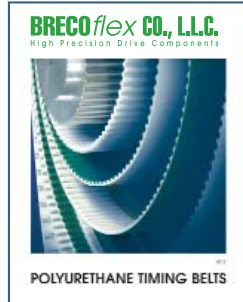

**Polyurethane Timing Belts**  
Metric and English pitches

See BRECOflex catalog # B212

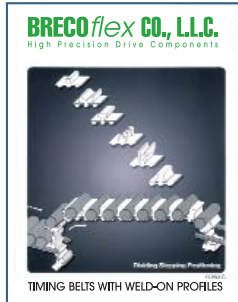

**Polyurethane Timing Belts with Weld-on Profiles**  
Dividing, Stepping, Positioning

See BRECOflex catalog # B203

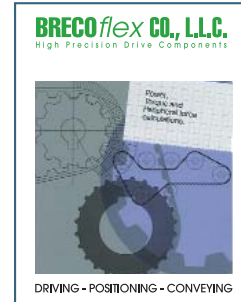

**Calculations Driving, Positioning, Conveying**  
Power, Torque, and Peripheral Force calculations

See BRECOflex catalog # B204

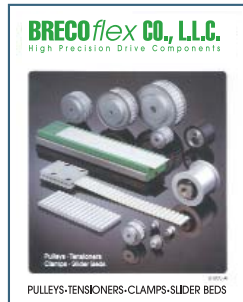

**Accessory Items for Polyurethane Timing Belts**  
Pulleys, Tensioners, Clamps, Slider Beds

See BRECOflex catalog # B205

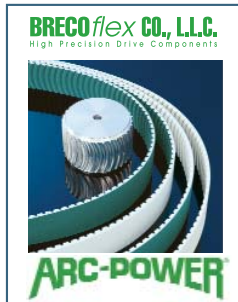

**Polyurethane Timing Belts ARC-POWER-BATIO**  
Circular "ARC" tooth shape

See BRECOflex catalog # B206



**Tension Meter**  
Improve performance, lifetime, positioning accuracy, bearing load, and noise level.

See BRECOflex catalog # B207



**Timing Belt Backings**  
Polyurethane Timing Belts in Metric and English pitches with a wide range of cover materials

See BRECOflex catalog # B208



**ATN®-Convertible Timing Belt System**  
ATN technology allows the reconfiguration of profiled timing belts at the customer site.

See BRECOflex catalog # B209



**ESBAND Truly Endless Woven Flat Belts**  
Wide variety of Polyurethane, Neoprene and Silicone state-of-the-art flat belts

See BRECOflex catalog # B210

All recommendations for the use of the products described herein and all other data or information set forth in this publication, whether concerning such products or otherwise, are furnished without any guarantee, warranty representations or inducement of any kind whether express or implied, including but not limited to warranties of merchantability and fitness for a particular purpose.

BRECOflex CO., L.L.C. expressly disclaims liability under any theory, including without limitation, contract negligence, misrepresentation or breach of any obligation relating to the recommendation, data or information set forth herein. Readers and customers are encouraged to conduct their own test before using any product. Read its label and all related instructions.

# SUPERIOR TIMING BELT BACKINGS

## HARDNESS

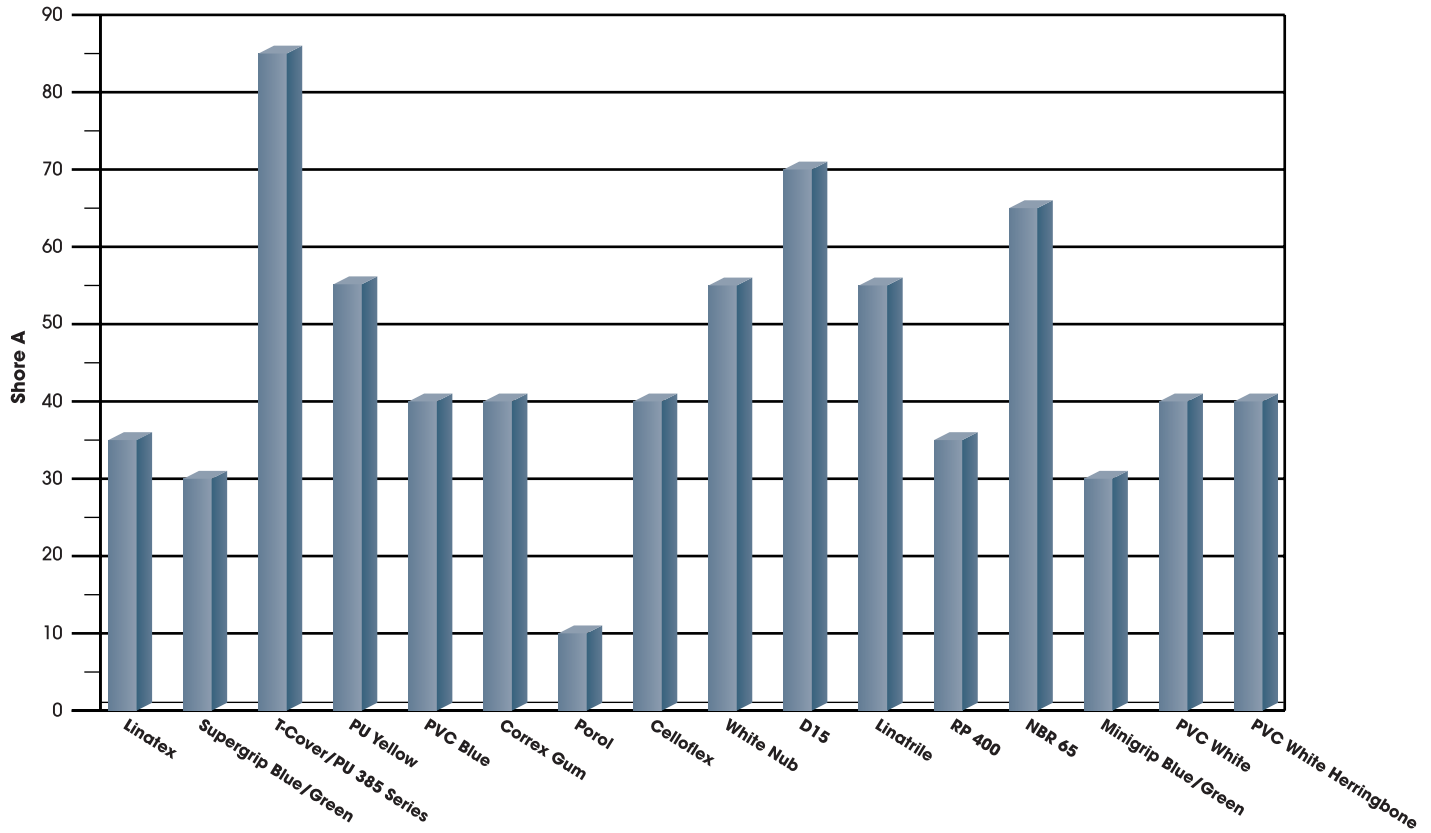

## COEFFICIENT OF FRICTION

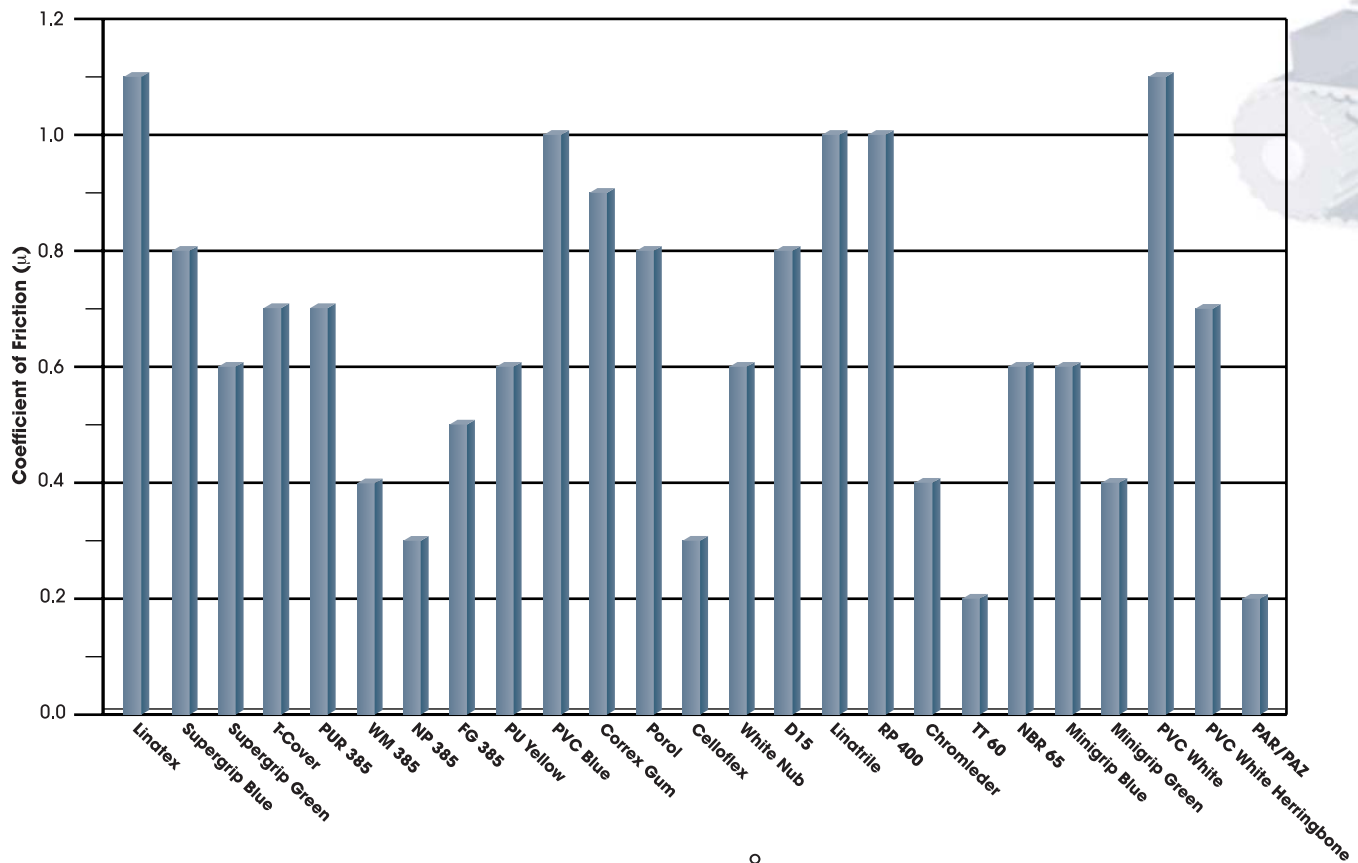



# SUPERIOR TIMING BELT BACKINGS

## BENDING ABILITY

-see backing specifications page 6

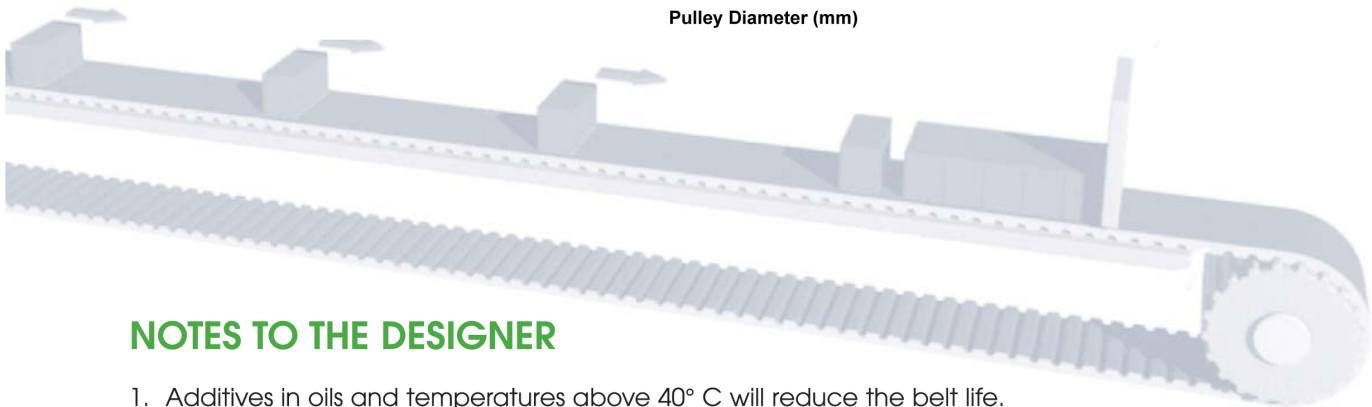
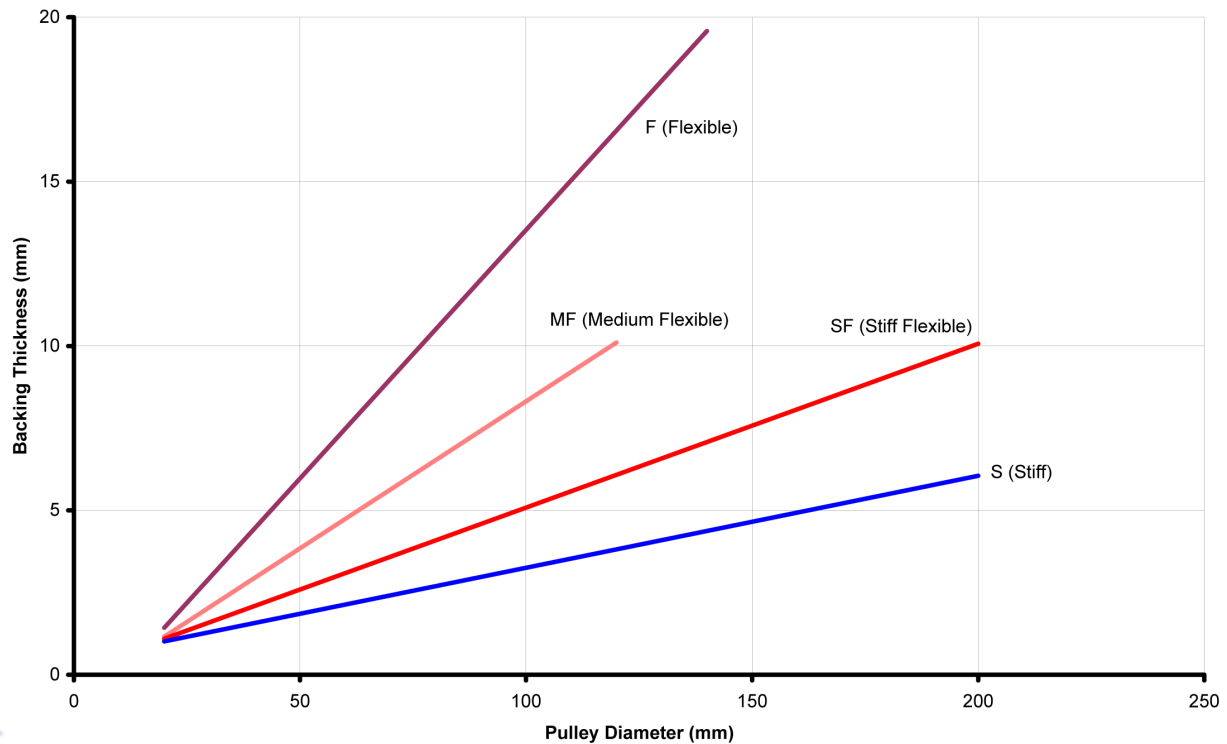

## NOTES TO THE DESIGNER

1. Additives in oils and temperatures above 40° C will reduce the belt life.
2. The coefficient of friction changes with temperature.
3. Low ambient temperatures reduce flexibility of the backing material. Pulley and idler diameters must be increased accordingly.
4. Covered belt applications may require increased pulley and idler diameters in standard and back bending operations.

# BRECO *flex* CO., L.L.C.

High Precision Drive Components



Printed in USA 06/06

**BRECO *flex* CO., L.L.C.**  
High Precision Drive Components

PO Box 829 • 222 Industrial Way West • Eatontown, NJ 07724  
Toll Free: 1-888-463-1400 • Tel: 732-460-9500 • Fax: 732-542-6725  
[www.brecoflex.com](http://www.brecoflex.com) • e-mail: [info@brecoflex.com](mailto:info@brecoflex.com)