

Series K3

 **DAVID BROWN**

CAT.K3-08/05.NA



CONEDRIVE
GEARING SOLUTIONS

PRODUCTS IN THE RANGE

Serving an entire spectrum of mechanical drive applications from food, energy, mining and metal; to automotive, aerospace and marine propulsion, Textron Fluid & Power is here to make a positive difference to the supply of drive solutions.

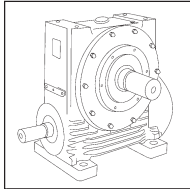

Series A
Worm Gear units
and geared motors
in single & double
reduction types

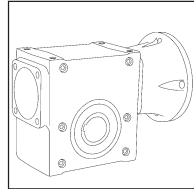

Series B
Conax helicoidal
gear geometry right
angle gearmotors
and reducers

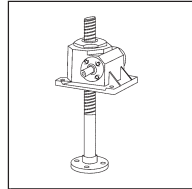

Series BD
Screwjack worm
gear unit

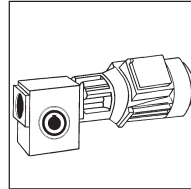

Series BS
Worm gear unit

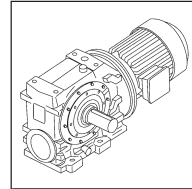

Series C
Right angle drive
helical worm geared
motors & reducers

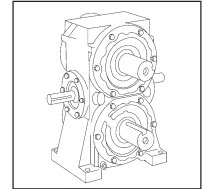

DuoDrive
Dual gears on
parallel output
shafts

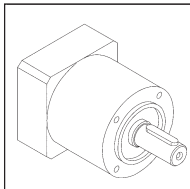

Series E
Economical
planetary servo
gearboxes

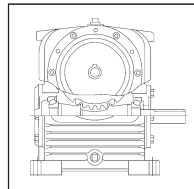

Extruder Drive
Rugged duty
reducer takes high
screw pressure

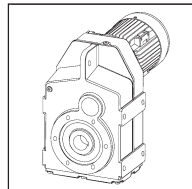

Series F
Parallel angle
helical bevel helical
geared motors &
reducers

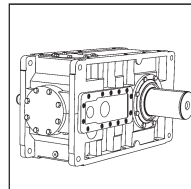

Series G
Helical parallel shaft
& bevel helical right
angle drive gear
units

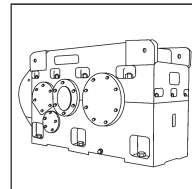

Series H
Large helical
parallel shaft &
bevel helical right
angle drive units

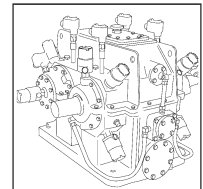

Highspeed
Helical parallel shaft
high speed units

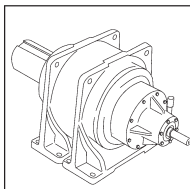

HTP
High torque
planetary gear units

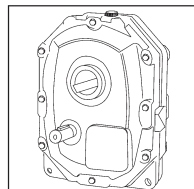

Series J
Shaft mounted
helical speed
reducers

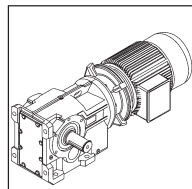

Series K
Right angle helical
bevel helical geared
motors & reducers

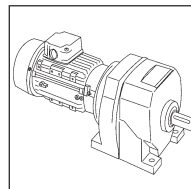

Series M
In-line helical
geared motors &
reducers

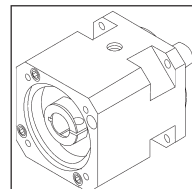

Series P
Precision planetary
servo gearboxes

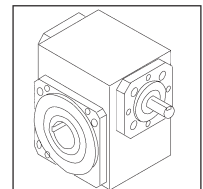

Series W
Precision right angle
servo gearboxes

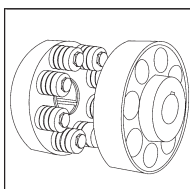

**Series X
Cone Ring**
Pin and bush
elastomer coupling

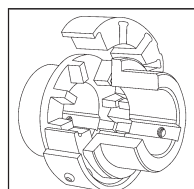

**Series X
Flexiwrap**
Double flexing
elastomer coupling

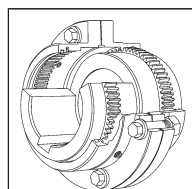

**Series X
Gear**
Torsionally rigid,
high torque coupling

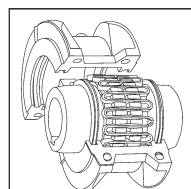

**Series X
Grid**
Double flexing steel
grid coupling

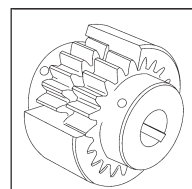

**Series X
Nylicon**
Gear coupling with
nylon sleeve

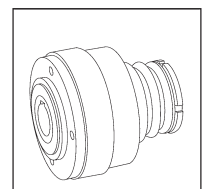

**Series X
Torque Limiter**
Overload protection
device

Textron Fluid & Power can create custom engineered transmission solutions of any size and configuration.

0508

General Description _____	2
Unit Designations _____	3
Unit Handings _____	4
Output Shaft Options _____	5 - 6
Mounting Position _____	7
Motor Mounting Code _____	8
Additional Gearbox Features _____	9
Explanation and use of Ratings and service Factors _____	10 - 11
Ratings _____	12 - 13
Overhung & Axial Loads on Shaft _____	14 - 15
Dimensions Sheets _____	16 - 24
C-Face (B14) Mounting Dimensions _____	25
General Specification _____	26
Product Safety _____	27

0503

Series K3 right angle helical bevel helical servo geared units offer ratios from 8 : 1 to 160 : 1 in three stages. The Series K3 geared servo drive is designed with integral cast feet for base or end mounting and can be offered with single or double extended output shafts. Units are also available shaft mounted or with output flanges and are available for mounting horizontally or vertically. The units can also be offered with a bolt on torque reaction bracket and all variants are available with either a servo adaptor or with an input shaft assembly.

Adding to our range of power transmission geared motors, this product takes advantage of our many years of accumulated design expertise together with the use of high quality materials and components. The end result is a series of speed reducing geared motors offering high load carrying capacities, increased efficiency, quiet running and reliability.

The range includes:

6 sizes of units K03, K04, K05, K06, K07, K08

- Version B - standard unit with feet
- Version F or H - standard unit with output flange
- Version T or Q - standard unit with torque bracket

Unit Types:

Unit type R - Reducer unit

Design Features Include:

Ability to fit double oil seals, on input shaft as required.

All units are dimensionally interchangeable with other major manufacturers.

Units are manufactured and assembled from a family of modular kits for distributor friendliness minimizing inventory and maximizing availability.

As improvements in design are being made continually, this specification is not to be regarded as binding in detail and drawings and capacities are subject to alteration without notice.

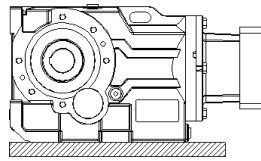

Servo
Triple reduction
Standard unit with feet

* K 0 5 3 2 5 0 . B 3 N 3 1 - C G K C - -

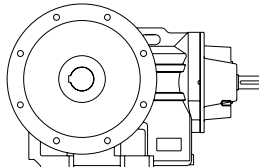

Reducer
Triple reduction
Standard unit with output flange on left

* K 0 6 3 2 5 0 . F R G - 1 - - - - - - -

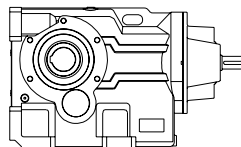

Reducer
Triple reduction
Standard unit with feet

* K 0 8 3 2 5 0 . B R N - 1 - - - - - - -

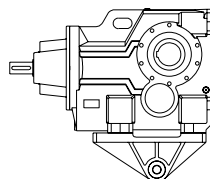

Reducer
Triple reduction
Standard unit with torque bracket

* K 0 3 3 2 5 0 . T R A - 1 - - - - - - -

* Typical unit designations

0503

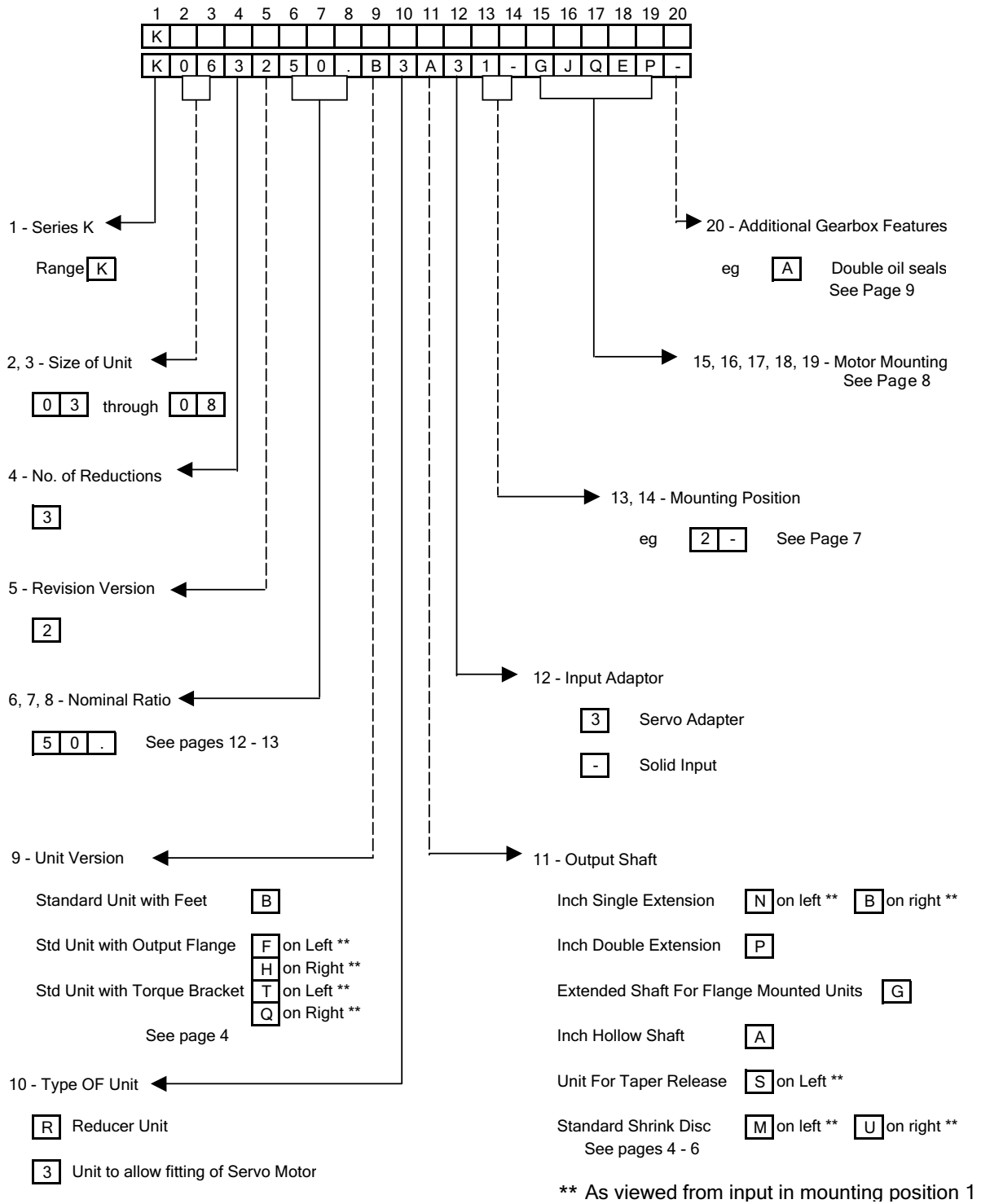

0503

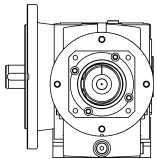
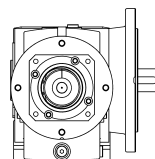
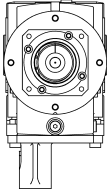
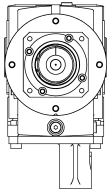
Column 9 Entry	Left	Right
Std Unit with Output Flange	F 	H 
Std Unit with Torque Bracket	T 	Q 

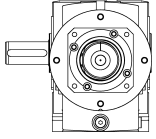
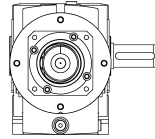
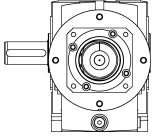
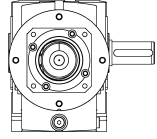
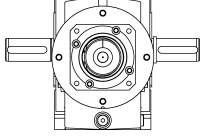
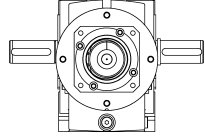
Column 11 Entry	Metric		Inch	
	Left	Right	Left	Right
Single Output Shaft	C 	E 	N 	B 
Double Output Shaft	D 		P 	

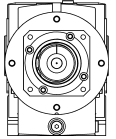
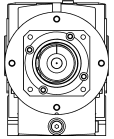
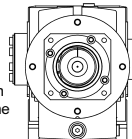
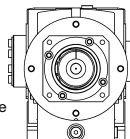
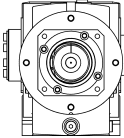
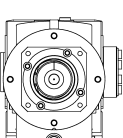
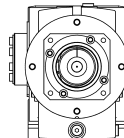
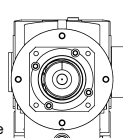
Hollow Shaft	H 	A 		
Taper Release	V  Driven Machine Side	S  Driven Machine Side		
Shrink Disc	X  Driven Machine Side <small>Note: non-standard handing, please contact us</small>	Y  Driven Machine Side	M  Driven Machine Side <small>Note: non-standard handing, please contact us</small>	U  Driven Machine Side

0503

**OUTPUT BORE OPTIONS,
COLUMN 11 ENTRY**

Standard Inch / Metric Hollow Shaft

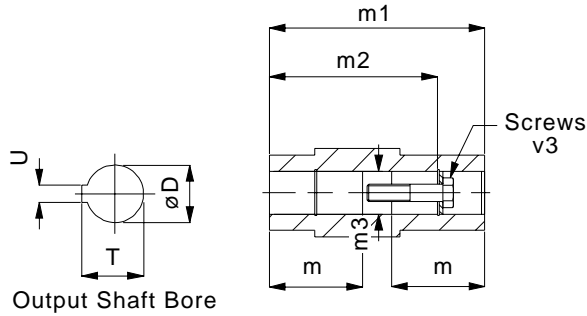

Column 11 Entry

- Inch Hollow Shaft A
- Inch Taper Release * S on Left
- Inch Shrink Disc * M on Left U on Right
- Metric Hollow Shaft H
- Metric Taper Release * V on Left
- Metric Shrink Disc * X on Left Y on Right

* See pages 19 - 21 for dimensions of these shaft options

SIZE OF UNIT	TYPE OF BORE	COLUMN 11 ENTRY	DIMENSIONS IN INCHES (Metric bore in mm)							
			øD	m	m1	m2	øm3	T	U	v3
K03	Inch	A	1.251" / 1.250"	2.07"	4.724"	4.13"	1.26"	1.377"	0.250"	³ / ₈ " UNF x 2" LONG
	Metric	H	30.021 / 30.000	52.5	120	105	30.3	33.5	8	M10x50L
K04	Inch	A	1.376" / 1.375"	2.60"	5.906"	5.12"	1.38"	1.525"	0.3125"	¹ / ₂ " UNF x 2 ¹ / ₄ " LONG
	Metric	H	35.025 / 35.000	66	150	132	35.3	38.5	10	M12x55L
K05	Inch	A	1.501" / 1.500"	2.87"	6.535"	5.59"	1.51"	1.675"	0.375"	⁵ / ₈ " UNF x 2 ³ / ₄ " LONG
	Metric	H	40.025 / 40.000	73	166	142	40.3	43.5	12	M16x70L
K06	Inch	A	1.501" / 1.500"	3.15"	7.087"	6.14"	1.51"	1.675"	0.375"	⁵ / ₈ " UNF x 2 ³ / ₄ " LONG
	Metric	H	40.025 / 40.000	80	180	156	40.3	43.5	12	M16x70L
K07	Inch	A	2.001" / 2.000"	3.64"	8.268"	7.20"	2.02"	2.230"	0.500"	⁵ / ₈ " UNF x 2 ³ / ₄ " LONG
	Metric	H	50.025 / 50.000	92.5	210	183	50.5	54	14	M16x70L
K08	Inch	A	2.3762"/2.3750"	4.134"	9.449"	8.268"	2.382"	2.656"	0.625"	³ / ₄ " - 16 UNF x 3 ¹ / ₄ " LONG
	Metric	H	60.030/60.000	105	240	210	60.5	64.5	18	M20x80L

0503

OUTPUT SHAFT OPTIONS,
COLUMN 11 ENTRY

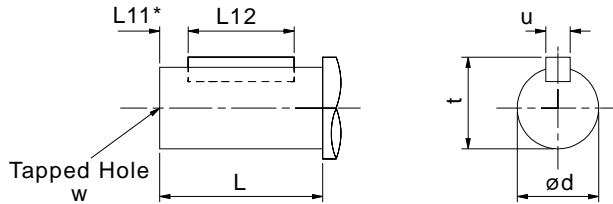

Column 11 Entry

- Inch Single Extension N on Left B on Right
- Inch Double Extension P
- Inch Extended Shaft for Flange Mount Units G
- Metric Single Extension C on Left E on Right
- Metric Double Extension D
- Metric Extended Shaft for Flange Mounted Units F

SIZE OF UNIT	TYPE OF OUTPUT SHAFT	COLUMN 11 ENTRY	DIMENSIONS IN MM (Inch shaft in inches)						
			ød	L	L11	L12	t	u	w
K03	Inch Single Ext.	N / B / G	1.0000" / 0.9995"	1.85"	*	1.44"	1.106"	0.25"	3/8 UNF x 0.75" Deep
	Inch Double Ext.	P	1.0000" / 0.9995"	1.85"	*	1.44"	1.106"	0.25"	3/8 UNF x 0.75" Deep
	Metric Single Ext.	C / E / F	25.015 / 25.002	47	3	40	28	8	M10 x 1.5 x 22 Deep
	Metric Double Ext.	D	25.015 / 25.002	47	3	40	28	8	M10 x 1.5 x 22 Deep
K04	Inch Single Ext.	N / B / G	1.2500" / 1.2495"	2.20"	*	2"	1.359"	0.25"	1/2 UNF x 1.13" Deep
	Inch Double Ext.	P	1.2500" / 1.2495"	2.20"	*	2"	1.359"	0.25"	1/2 UNF x 1.13" Deep
	Metric Single Ext.	C / E / F	30.015 / 30.002	56	3	50	33	8	M12 x 1.75 x 28 Deep
	Metric Double Ext.	D	30.015 / 30.002	56	3	50	33	8	M12 x 1.75 x 28 Deep
K05	Inch Single Ext.	N / B / G	1.3750" / 1.3745"	2.60"	*	2.375"	1.507"	0.3125"	5/8 UNF x 1.5" Deep
	Inch Double Ext.	P	1.3750" / 1.3745"	2.60"	*	2.375"	1.507"	0.3125"	5/8 UNF x 1.5" Deep
	Metric Single Ext.	C / E / F	35.018 / 35.002	66	3	60	38	10	M16 x 2 x 36 Deep
	Metric Double Ext.	D	35.018 / 35.002	66	3	60	38	10	M16 x 2 x 36 Deep
K06	Inch Single Ext.	N / B / G	1.625" / 1.624"	3.00"	*	2.375"	1.784"	0.375"	5/8 UNF x 1.5" Deep
	Inch Double Ext.	P	1.4996" / 1.4990"	3.00"	*	2.375"	1.664"	0.375"	5/8 UNF x 1.5" Deep
	Metric Single Ext.	C / E / F	40.018 / 40.002	76	3	70	43	12	M16 x 2 x 36 Deep
	Metric Double Ext.	D	39.991 / 39.975	76	3	70	43	12	M16 x 2 x 36 Deep
K07	Inch Single Ext.	N / B / G	2.000" / 1.999"	3.74"	*	2.75"	2.228"	0.50"	5/8 UNF x 1.5" Deep
	Inch Double Ext.	P	2.000" / 1.999"	3.74"	*	2.75"	2.228"	0.50"	5/8 UNF x 1.5" Deep
	Metric Single Ext.	C / E / F	50.018 / 50.002	95	3	80	53.5	14	M16 x 2 x 36 Deep
	Metric Double Ext.	D	49.991 / 49.975	95	3	80	53.5	14	M16 x 2 x 36 Deep
K08	Inch Single Ext.	N / B / G	2.3750" / 2.3740"	4.488"	*	3.6875"	2.65"	0.625"	3/4" 16 UNF x 1.65 Deep
	Inch Double Ext.	P	2.3746" / 2.3739"	4.488"	*	3.6875"	2.65"	0.625"	3/4" 16 UNF x 42 Deep
	Metric Single Ext.	C / E / F	60.030 / 60.011	114	3	100	64	18	M20 x 2.5 42 Deep
	Metric Double Ext.	D	59.990 / 59.971	114	3	100	64	18	M20 x 2.5 42 Deep

* Inch shaft has an open ended keyway, therefore no 'L11' dimension is required

0503

COLUMN 13 ENTRY

Base Mounted Units

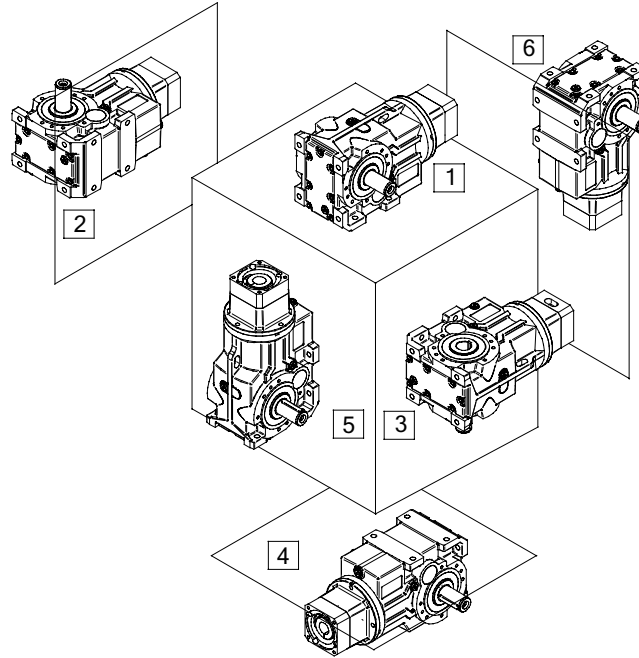

Flange Mounted Units

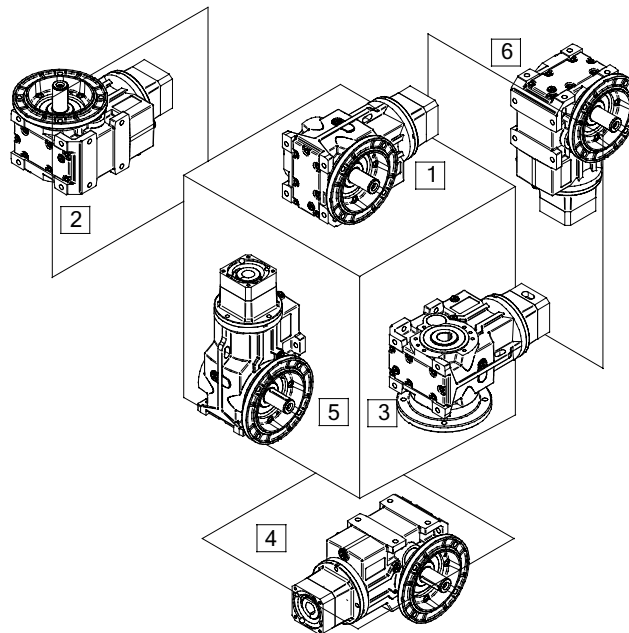

MOUNTING POSITIONS APPLY TO ALL REDUCERS

0503

SIZES K0332 AND K0432

Column 15 Entry	FLANGE SQUARE AND MOTOR SHAFT LENGTH						
	115			140			
	20 - 32	33 - 63	38 - 68	69 - 89			
	C	D	G	H			
Column 16 Entry	MOTOR PILOT DIAMETER						
	80	95	110	114.3	130		
	G	H	J	K	L		
Column 17 Entry	BOLT CIRCLE DIAMETER						
	100	115	130	145	149.23	165	200
	K	L	M	N	P	Q	R
Column 18 Entry	MOTOR FLANGE THRU HOLE				TAPPED HOLE		
	6.4-8.3	8.4-10.3	10.4-12.4	12.5-15.0	3/8 - 16		
	C	D	E	F	P		
Column 19 Entry	MOTOR SHAFT DIAMETER						
	14	16	19	22	24	28	
	G	J	K	M	P	R	

SIZES K0532 AND K0632

Column 15 Entry	FLANGE SQUARE AND MOTOR SHAFT LENGTH							
	115		140		190			
	20 - 32	33 - 63	38 - 68	69 - 89	38 - 68	58 - 87		
	C	D	G	H	K	L		
Column 16 Entry	MOTOR PILOT DIAMETER							
	80	95	110	114.3	130	180		
	G	H	J	K	L	M		
Column 17 Entry	BOLT CIRCLE DIAMETER							
	100	115	130	145	149.23	165	200	215
	K	L	M	N	P	Q	R	S
Column 18 Entry	MOTOR FLANGE THRU HOLE				TAPPED HOLE			
	6.4-8.3	8.4-10.3	10.4-12.4	12.5-15.0	3/8 - 16			
	C	D	E	F	P			
Column 19 Entry	MOTOR SHAFT DIAMETER							
	14	16	19	22	24	28	32	35
	G	J	K	M	P	R	U	W

SIZES K0732 AND K0832

Column 15 Entry	FLANGE SQUARE AND MOTOR SHAFT LENGTH							
	140		190					
	38 - 68	69 - 89	38 - 68	58 - 87				
	G	H	K	L				
Column 16 Entry	MOTOR PILOT DIAMETER							
	80	95	110	114.3	130	180		
	G	H	J	K	L	M		
Column 17 Entry	BOLT CIRCLE DIAMETER							
	100	115	130	145	149.23	165	200	215
	K	L	M	N	P	Q	R	S
Column 18 Entry	MOTOR FLANGE THRU HOLE				TAPPED HOLE			
	6.4-8.3	8.4-10.3	10.4-12.4	12.5-15.0	3/8 - 16			
	C	D	E	F	P			
Column 19 Entry	MOTOR SHAFT DIAMETER							
	22	24	28	32	35			
	M	P	R	U	W			

0503

ADDITIONAL GEARBOX FEATURES - COLUMN 20 ENTRY

Column 20 Entry	Double Oil Seals	Oil Level Glass	Special
-			
A	●		
B		●	
C	●	●	
L			●

Please contact our Application Engineers for details of the following additional gearbox features

- Prime paint only
- Wash down
- BISSC compatible
- Special oil (food compatible, bio-degradable, different viscosities etc)

0503

Gear unit selection is made by comparing the actual loads with catalog ratings. Catalog ratings are based on a standard set of loading conditions, whereas actual load conditions vary according to the type of application. Service Factors are therefore used to calculate an equivalent load to compare with catalog ratings.

i.e. Equivalent Torque = Application Torque x Service Factor

Mechanical Service Factor

1. Calculate total external inertia (gearbox inertia + load inertia reflected to the gearbox input).
2. Determine motor inertia from motor catalog.
3. Use the equation below to determine mass acceleration factor.

$$\text{Mass acceleration factor} = \frac{\text{total external inertia}}{\text{motor inertia}}$$

4. Use table 1 below to determine **Factor Fm**.

Table 1 Factor Fm

Prime Mover	Duration of service - hrs per day	Load Classification-driven machine		
		Uniform mass acceleration factor ≤ 0.2	Moderate mass acceleration factor ≤ 3	Heavy mass acceleration factor ≤ 10
Servo	Under 3	0.80	1.00	1.50
	3 to 10	1.00	1.25	1.75
	Over 10	1.25	1.50	2.00

5. Use table 2 below to determine Number of Starts **Factor Fs**.

Table 2 Factor Fs

Start/Stops (per hour)	Up to 1	100	200	300	400	500	700	900	1000	1200	1300	1400	1500
Factor (Fs)	1.00	1.15	1.20	1.22	1.23	1.24	1.25	1.26	1.27	1.28	1.28	1.29	1.30

$$\text{Total Mechanical Service Factor } SFm = Fm \times Fs.$$

6. **Equivalent Mechanical Torque = Application Torque x SFm.**

7. **Determine if application is continuous or cyclic:**

A. Will the gearbox operate for more than twenty minutes at one time?

B. During one cycle, is $\frac{\text{shaft turning time}}{\text{dwell at zero speed time}} > 1.5$?

C. If the answer to question A or B is **NO**, then the application is cyclic.

D. If the answer to question A or B is **YES**, then the application is continuous and **Thermal Service Factor must be considered (see next page).**

0503

1. Use table 3 below to determine Ambient Temperature Adjustment **Factor Ft**.

Table 3 Factor Ft

Unit Type	Ambient Temperature °F							
	-4 (-20°C)	14 (-10°C)	32 (0°C)	50 (10°C)	68 (20°C)	86 (30°C)	104 (40°C)	122 (50°C)
Factor (Ft)	0.64	0.70	0.78	0.88	1.00	1.16	1.41	2.00

2. Use table 4 below to determine Ambient Air Velocity Correction **Factor Fv**.

Table 4 Factor Fv

Operating Area	Fv
Small confined space	1.16
Large indoor space	1.00
Sheltered outdoor space	0.77
Outdoor space	0.67

3. Determine application motor speed.
4. Use table 5 below to determine Speed Correction **Factor Fsp**.

Table 5 Factor Fsp

RPM	1000	1500	2000	2500	3000
Factor (Fsp)	.75	.88	1	1.12	1.25

Total Thermal Service Factor SFth = Ft x Fv x Fsp

5. **Equivalent Thermal Torque = Application torque x SFth.**
6. Compare whichever is largest, **Equivalent Thermal Torque** or **Equivalent Mechanical Torque**, to published mechanical ratings (page 12 - 13). Published mechanical ratings must be greater than or equal to **Equivalent Thermal Torque** or **Equivalent Mechanical Torque**.

0503

Mechanical output torque ratings @ 2000 rpm input

Nominal Ratio	K03				K04				K05			
	Exact Ratio	Inertia lb.in.s ²	Output Torque		Exact Ratio	Inertia lb.in.s ²	Output Torque		Exact Ratio	Inertia lb.in.s ²	Output Torque	
			lb.in.	Nm			lb.in.	Nm			lb.in.	Nm
8:1	8.326	0.0127	1140	129	8.054	0.0151	2040	231	8.112	0.0207	3200	362
11:1	11.25	0.0121	1290	146	11.30	0.0133	2350	266	11.40	0.0170	3720	420
12:1	12.80	0.0119	1340	151	12.45	0.0130	2440	276	12.78	0.0162	3870	437
14:1	14.50	0.0117	1410	159	14.14	0.0126	2550	288	14.35	0.0155	4020	454
18:1	18.54	0.0115	1530	173	17.95	0.0121	2770	313	18.22	0.0143	4330	489
20:1	19.98	0.0115	1570	177	20.40	0.0119	2900	328	20.66	0.0138	4490	507
25:1	25.23	0.0114	1680	190	25.03	0.0117	3080	348	24.64	0.0133	4690	530
28:1	28.60	0.0113	1730	195	27.76	0.0116	3170	358	28.37	0.0129	4870	550
32:1	32.68	0.0113	1790	202	31.54	0.0115	3280	371	32.99	0.0126	5050	571
36:1	36.35	0.0113	1840	208	35.83	0.0115	3490	394	36.91	0.0125	5310	600
40:1	40.08	0.0113	1880	212	39.46	0.0114	3480	393	39.34	0.0123	5270	595
45:1	44.11	0.0112	1930	218	45.39	0.0114	3600	407	46.63	0.0120	5490	620
50:1	51.68	0.0112	1990	225	49.35	0.0113	3670	415	49.78	0.0120	5570	629
63:1	62.00	0.0112	1990	225	59.24	0.0113	3840	434	61.78	0.0117	5830	659
71:1	72.27	0.0112	1990	225	71.09	0.0112	3910	442	72.85	0.0116	5830	659
80:1	80.30	0.0112	1990	225	80.10	0.0112	3910	442	79.77	0.0115	5830	659
100:1	96.70	0.0112	1640	185	93.12	0.0112	3540	400	97.76	0.0114	5830	659
112:1	110.8	0.0112	1410	159	105.7	0.0112	3610	408	109.0	0.0114	5830	659
125:1	126.0	0.0112	1390	157	120.2	0.0112	3910	442	122.2	0.0114	5380	608

Mechanical output torque ratings @ 2000 rpm input

Nominal Ratio	K06				K07				K08			
	Exact Ratio	Inertia lb.in.s ²	Output Torque		Exact Ratio	Inertia lb.in.s ²	Output Torque		Exact Ratio	Inertia lb.in.s ²	Output Torque	
			lb.in.	Nm			lb.in.	Nm			lb.in.	Nm
8:1	7.961	0.0219	4550	514	8.595	0.0328	6970	788	8.128	0.0840	9090	1027
11:1	11.19	0.0172	5320	601	11.91	0.0247	9590	1084	11.52	0.0549	11600	1311
12:1	12.54	0.0161	5550	627	13.37	0.0228	10000	1130	12.80	0.0490	12300	1390
14:1	14.08	0.0153	5770	652	14.71	0.0217	10400	1175	14.24	0.0438	12900	1458
18:1	17.88	0.0139	6250	706	19.21	0.0189	11400	1288	18.41	0.0344	14500	1638
20:1	20.27	0.0134	6490	733	21.84	0.0179	11800	1333	20.67	0.0312	15100	1706
25:1	24.18	0.0129	6800	768	26.52	0.0172	12400	1401	25.35	0.0267	16300	1842
28:1	27.84	0.0125	7070	799	29.17	0.0166	12700	1435	28.56	0.0242	16700	1887
32:1	32.38	0.0122	7310	826	33.52	0.0158	13200	1492	33.24	0.0222	17700	2000
36:1	36.22	0.0122	7310	826	38.01	0.0156	13800	1559	36.88	0.0221	19900	2249
40:1	38.61	0.0120	7310	826	41.92	0.0148	13900	1571	40.36	0.0198	20000	2260
45:1	45.76	0.0118	7320	827	48.01	0.0145	14400	1627	45.66	0.0187	20700	2339
50:1	48.86	0.0117	7320	827	54.28	0.0141	14800	1672	51.54	0.0177	21200	2395
63:1	60.62	0.0116	7320	827	62.94	0.0138	14900	1684	62.47	0.0163	21700	2452
71:1	71.49	0.0115	7320	827	75.07	0.0135	14900	1684	72.86	0.0155	22200	2508
80:1	78.28	0.0114	7320	827	82.21	0.0134	14900	1684	80.03	0.0152	22700	2565
100:1	95.93	0.0113	7320	827	98.65	0.0132	14900	1684	98.08	0.0144	23300	2633
112:1	106.9	0.0113	7320	827	113.5	0.0131	14400	1627	107.1	0.0142	23500	2655
125:1	119.9	0.0113	5270	595	126.1	0.0130	12200	1379	123.3	0.0140	23700	2678

0503

Maximum permissible overhung loads

When a sprocket, gear etc. is mounted on the shaft, the calculation below must be made to determine the overhung load on the shaft, and the results compared to the maximum permissible overhung loads tabulated. Overhung loads can be reduced by increasing the diameter of the sprocket, gear, etc. If the maximum permissible overhung load is exceeded, the sprocket, gear, etc. should be mounted on a separate shaft, flexibly coupled and supported in its own bearings, or the gear unit shaft should be extended to run in an outboard bearing. Alternatively, a larger gear is often a less expensive solution.

Permissible overhung loads vary according to the direction of rotation. The values tabulated are for the most unfavorable direction with the unit transmitting full rated power and the load P applied midway along the shaft extension. Hence they can sometimes be increased for a more favorable direction of rotation, or if the power transmitted is less than the rated capacity of the gear unit, or if the load is applied nearer to the gear unit case. Refer to our Application Engineers for further details. In any event, the sprocket, gear etc. should be positioned as close as possible to the gear unit case in order to reduce bearing loads and shaft stresses, and to prolong life.

All units will accept 100% momentary overload on stated capacities.

Overhung load (lbf)

$$P = \frac{HP \times 126,000 \times K}{N \times D}$$

where

- P = equivalent overhung load (lbf)
- HP = power transmitted by the shaft (HP)
- N = speed of shaft (rev/min)
- D = pitch diameter of sprocket, etc. (in)
- K = factor

Overhung member K (factor)

- Chain sprocket* 1.00
- Spur or helical pinion 1.25
- Vee belt sheave 1.50
- Flat belt pulley 2.00

* If multistrand chain drives are equally loaded and the outer strand is further than dimension Fra output or Frb input, refer to our Application Engineers.

Note: 1 lbf = 4.4484 Newtons.

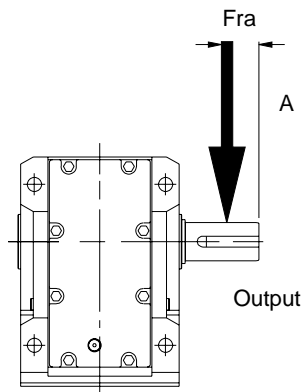
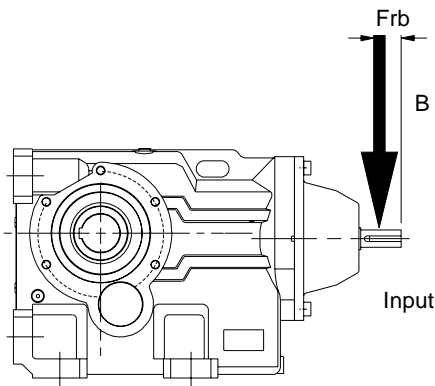

Distance midway along the shaft extension

Size of unit	No. of Reductions	Dimension A (Inches)	Dimension B (Inches)
K03	3	0.93	0.79
K04	3	1.10	0.79
K05	3	1.30	0.79
K06	3	1.50	0.79
K07	3	1.87	0.98
K08	3	1.97	1.18

0503

Input Shaft Overhung Loads, Frb (lbf) 2000 rpm**Three Stage Units**

	K03	K04	K05	K06	K07	K08
3 Stage	275	284	236	201	393	586

Axial Thrust Capacities (lbs)

No check or calculation is required for axial loads (F_A) towards or away from the unit up to 50% of the permissible overhung load. If the axial thrust considerably exceeds these values or if there is a combination of axial thrust loads and overhung loads please contact our Application Engineers.

0503

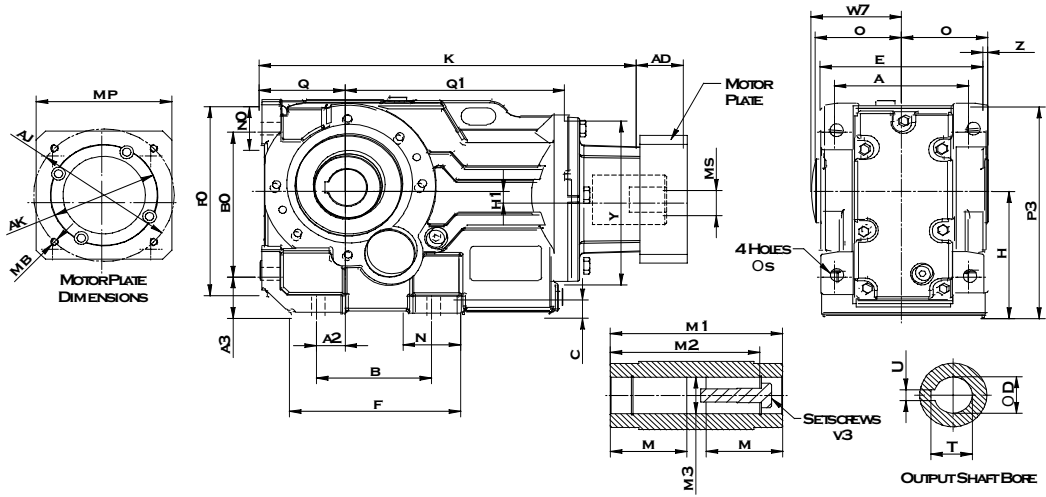

SIZE	a	a2	a3	b	b0	c	e	f	f0	h	h1	n	n0	o	p3	q	q1	s
K0332	3.94	1.10	1.26	4.33	4.53	0.43	4.72	5.63	5.98	3.94	0.63	1.50	1.50	2.36	6.57	2.48	6.26	0.43
K0432	4.72	1.38	1.46	5.12	5.12	0.63	5.71	6.61	6.73	4.41	0.51	1.50	1.57	2.95	7.36	2.80	7.05	0.43
K0532	5.12	1.18	1.77	5.12	5.91	0.59	6.18	6.69	7.56	5.20	0.20	1.57	1.57	3.27	8.54	3.15	8.62	0.55
K0632	5.51	1.18	1.77	4.72	6.30	0.79	6.69	6.93	8.19	5.51	0.51	2.17	1.89	3.54	9.17	3.54	9.02	0.55
K0732	6.50	1.57	2.17	5.91	7.87	1.06	7.87	8.27	10.35	7.09	0.98	2.36	2.17	4.13	11.34	4.41	10.43	0.71
K0832	7.09	2.17	2.76	7.09	9.17	1.18	9.06	10.08	12.17	8.35	0.59	2.99	2.99	4.72	13.43	5.20	12.99	0.91

SIZE	w7	y	z	Hollow Output Bore								k	ad Max	ak	aj	mp	mb	ms
				D	m	m1	m2	m3	T	U	v3							
K0332	2.48	5.51	0	1.25	2.07	4.724	4.13	1.26	1.377	0.250	3/8 UNF x 2 long	12.20	2.72	Motor Plate & Coupling Dimensions are made to fit your servo motor. Refer to page 9 for available dimensions.	mp	mb	ms	
K0432	3.07	5.51	0.10	1.375	2.60	5.906	5.12	1.38	1.525	0.3125	1/2 UNF x 2 1/4 long	13.31	2.72					
K0532	3.43	7.09	0.18	1.50	2.87	6.535	5.59	1.51	1.675	0.375	5/8 UNF x 2 3/4 long	14.70	2.72					
K0632	3.70	7.09	0.20	1.50	3.15	7.087	6.14	1.51	1.675	0.375	5/8 UNF x 2 3/4 long	15.49	2.72					
K0732	4.29	8.35	0.20	2.00	3.64	8.268	7.20	2.02	2.230	0.500	5/8 UNF x 2 3/4 long	18.08	2.72					
K0832	4.88	9.84	0.20	2.375	4.134	9.449	8.268	2.382	2.656	0.625	3/4-16 UNF x 3 1/4 long	21.03	2.72					

**DIMENSIONS
OUTPUT SHAFT OPTIONS**

0504

STANDARD OUTPUT SHAFT OPTION

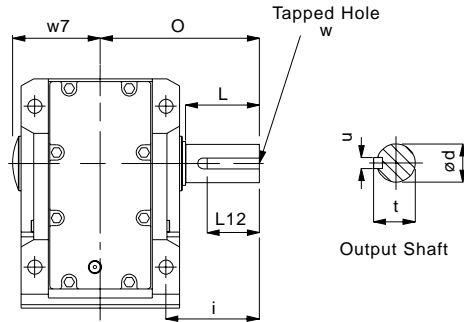

SIZE	ød	i	L	L12	O	t	u	w	w7
K0332	1.0000 / 0.9995	2.36	1.85	1.44	4.33	1.106	0.25	3/8 UNF x 0.75" Deep	2.48
K0432	1.2500 / 1.2495	2.95	2.20	2	5.31	1.359	0.25	1/2 UNF x 1.13" Deep	3.07
K0532	1.3750 / 1.3745	3.46	2.60	2.375	6.02	1.507	0.3125	5/8 UNF x 1.5" Deep	3.43
K0632	1.625 / 1.624	3.98	3.00	2.375	6.73	1.784	0.375	5/8 UNF x 1.5" Deep	3.70
K0732	2.000 / 1.999	4.86	3.74	2.75	8.11	2.228	0.50	5/8 UNF x 1.5" Deep	4.29
K0832	2.375 / 2.374	5.91	4.488	3.6875	9.45	2.65	0.625	3/4" 16 UNF x 1.65 Deep	4.88

STANDARD DOUBLE EXTENDED OUTPUT SHAFT OPTION

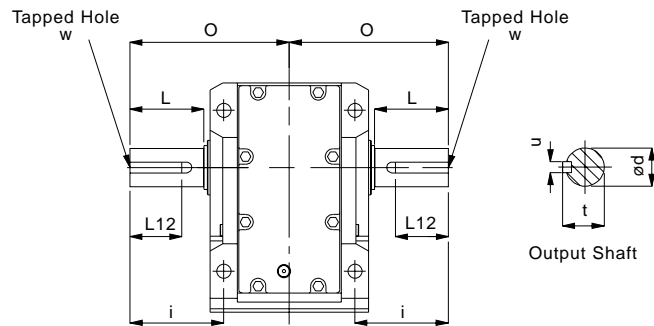

SIZE	d	i	L	L12	O	t	u	w
K0332	1.0000 / 0.9995	2.36	1.85	1.44	4.33	1.106	0.25	3/8 UNF x 0.75" Deep
K0432	1.2500 / 1.2495	2.95	2.20	2	5.31	1.359	0.25	1/2 UNF x 1.13" Deep
K0532	1.3750 / 1.3745	3.46	2.60	2.375	6.02	1.507	0.3125	5/8 UNF x 1.5" Deep
K0632	1.4996 / 1.4990	3.98	3.00	2.375	6.73	1.664	0.375	5/8 UNF x 1.5" Deep
K0732	2.000 / 1.999	4.86	3.74	2.75	8.11	2.228	0.50	5/8 UNF x 1.5" Deep
K0832	2.3746 / 2.3739	5.91	4.488	3.6875	9.45	2.65	0.625	3/4" 16 UNF x 42 Deep

0504

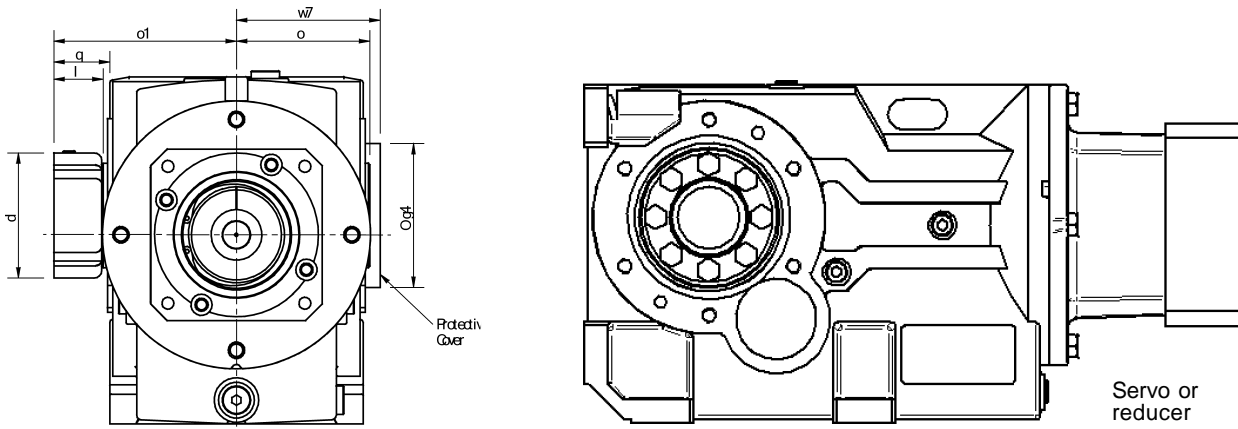

Note: Only available as standard in this handing, please contact us for opposite handing

Driven shaft

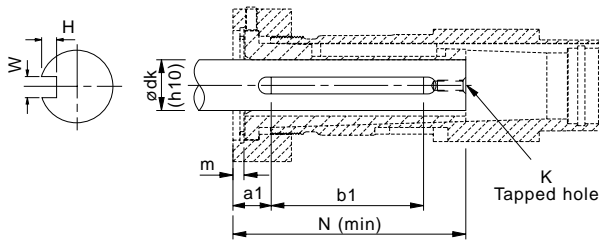

Thin walled

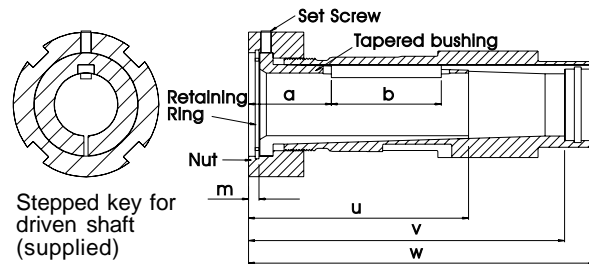

End plate (not supplied)

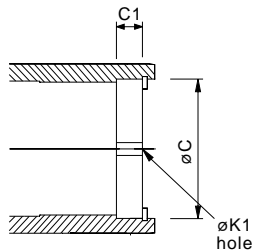

Thick walled

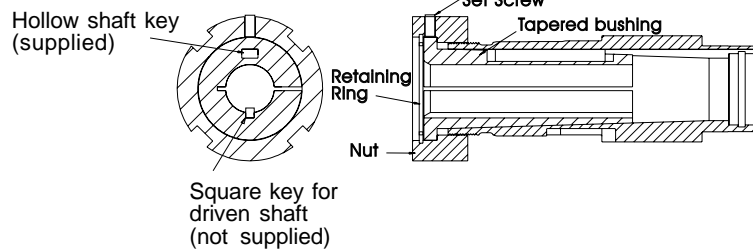

- Consult standard unit selection tables for HP and torque ratings

SIZE	key		bush	hollow shaft			nut			gear unit			cover	
	a	b	u	v	w	d	l	m	o	o1	q	g4	w7	
K05 (107)TR	1.90	2.50	5.00	7.50	8.20	3.31	1.26	0.27	4.57	3.27	1.61	4.25	4.65	
K06 (115)TR	2.10	2.75	5.55	8.50	9.88	4.06	1.46	0.30	5.04	3.54	1.77	5.24	5.51	
K07 (203)TR	1.55	3.25	5.55	9.55	11.30	4.31	1.46	0.30	5.35	4.13	1.61	5.24	5.98	
K08 (207)TR	1.24	4.25	6.11	10.00	11.00	4.81	1.46	0.30	6.56	4.72	2.03	6.38	6.89	

- All other gear unit dimensions may be obtained from the standard unit dimension pages

0503

size	Driven shaft diameter * (ødk)	bushing style	driven shaft keyway			driven shaft			end plate			circlip	bushing weight (lbs)
			width (W)	depth (H)	min length ▲ (b1)	a1	K	N(min)	øC	C1	K1		
K05 (107)TR	1.000 / 0.996	Thick	1/4	1/8	2.75	-	1/2 UNC	5.0	1.64	0.30	5/8 UNC	N1300-0162	2.1
	1.125 / 1.121	Thick	1/4	1/8	2.75	-	1/2 UNC	5.0	1.64	0.30	5/8 UNC	N1300-0162	1.8
	1.188 / 1.184	Thick	1/4	1/8	2.75	-	1/2 UNC	5.0	1.64	0.30	5/8 UNC	N1300-0162	1.6
	1.250 / 1.246	Thin	1/4	1/8	2.50	1.89	1/2 UNC	5.0	1.64	0.30	5/8 UNC	N1300-0162	1.5
	1.438 / 1.434	Thin	3/8	3/16	2.50	1.89	1/2 UNC	5.0	1.64	0.30	5/8 UNC	N1300-0162	1.0
K06 (115)TR	1.188 / 1.184	Thick	1/4	1/8	2.75	-	1/2 UNC	5.55	2.25	0.37	5/8 UNC	N1300-0225	4.3
	1.250 / 1.246	Thick	1/4	1/8	2.75	-	1/2 UNC	5.55	2.25	0.37	5/8 UNC	N1300-0225	4.1
	1.438 / 1.434	Thick	3/8	3/16	2.50	-	1/2 UNC	5.55	2.25	0.37	5/8 UNC	N1300-0225	3.5
	1.500 / 1.496	Thick	3/8	3/16	2.50	-	1/2 UNC	5.55	2.25	0.37	5/8 UNC	N1300-0225	3.3
	1.625 / 1.620	Thin	3/8	3/16	2.75	2.10	1/2 UNC	5.55	2.25	0.37	5/8 UNC	N1300-0225	2.9
	1.688 / 1.683	Thin	3/8	3/16	2.75	2.10	1/2 UNC	5.55	2.25	0.37	5/8 UNC	N1300-0225	2.7
	1.750 / 1.745	Thin	3/8	3/16	2.75	2.10	1/2 UNC	5.55	2.25	0.37	5/8 UNC	N1300-0225	2.4
K07 (203)TR	1.438 / 1.434	Thick	3/8	3/16	2.75	-	5/8 UNC	5.55	2.43	0.43	3/4 UNC	N1300-0244	5.0
	1.500 / 1.496	Thick	3/8	3/16	2.75	-	5/8 UNC	5.55	2.43	0.43	3/4 UNC	N1300-0244	5.1
	1.625 / 1.620	Thick	3/8	3/16	2.75	-	5/8 UNC	5.55	2.43	0.43	3/4 UNC	N1300-0244	4.6
	1.688 / 1.683	Thick	3/8	3/16	2.75	-	5/8 UNC	5.55	2.43	0.43	3/4 UNC	N1300-0244	4.4
	1.750 / 1.745	Thick	3/8	3/16	2.75	-	5/8 UNC	5.55	2.43	0.43	3/4 UNC	N1300-0244	4.4
	1.875 / 1.870	Thin	1/2	1/4	3.25	1.56	5/8 UNC	5.55	2.43	0.43	3/4 UNC	N1300-0244	3.6
	1.938 / 1.933	Thin	1/2	1/4	3.25	1.56	5/8 UNC	5.55	2.43	0.43	3/4 UNC	N1300-0244	3.3
	2.000 / 1.995	Thin	1/2	1/4	3.25	1.56	5/8 UNC	5.55	2.43	0.43	3/4 UNC	N1300-0244	3.0
	2.188 / 2.183	Thin	1/2	1/4	3.25	1.56	5/8 UNC	5.55	2.43	0.43	3/4 UNC	N1300-0244	3.0
K08 (207)TR	1.375 / 1.371	Thick	3/16	5/32	4.75	-	5/8 UNC	6.11	2.83	0.43	3/4 UNC	N1300-0281	7.6
	1.438 / 1.434	Thick	3/8	3/16	3.25	-	5/8 UNC	6.11	2.83	0.43	3/4 UNC	N1300-0281	7.3
	1.500 / 1.496	Thick	3/8	3/16	3.25	-	5/8 UNC	6.11	2.83	0.43	3/4 UNC	N1300-0281	7.1
	1.625 / 1.620	Thick	3/8	3/16	3.25	-	5/8 UNC	6.11	2.83	0.43	3/4 UNC	N1300-0281	6.7
	1.688 / 1.683	Thick	3/8	3/16	3.25	-	5/8 UNC	6.11	2.83	0.43	3/4 UNC	N1300-0281	6.4
	1.750 / 1.745	Thick	3/8	3/16	3.25	-	5/8 UNC	6.11	2.83	0.43	3/4 UNC	N1300-0281	6.1
	1.875 / 1.870	Thick	1/2	1/4	3.25	-	5/8 UNC	6.11	2.83	0.43	3/4 UNC	N1300-0281	5.6
	1.938 / 1.933	Thin	1/2	1/4	4.25	1.24	5/8 UNC	6.11	2.83	0.43	3/4 UNC	N1300-0281	5.3
	2.000 / 1.995	Thin	1/2	1/4	4.25	1.24	5/8 UNC	6.11	2.83	0.43	3/4 UNC	N1300-0281	5.0
	2.188 / 2.183	Thin	1/2	1/4	4.25	1.24	5/8 UNC	6.11	2.83	0.43	3/4 UNC	N1300-0281	4.4
	2.250 / 2.245	Thin	1/2	1/4	4.25	1.24	5/8 UNC	6.11	2.83	0.43	3/4 UNC	N1300-0281	3.7
2.438 / 2.433	Thin	5/8	5/16	4.25	1.24	5/8 UNC	6.11	2.83	0.43	3/4 UNC	N1300-0281	2.6	

* Check strength of driven shaft

▲ Check strength and length of key (when key not supplied ie thick wall bushing)

0504

The gear unit is fitted with a 'shrink disc' device located on the hollow output shaft to provide a positive outer locking connection between gear unit and driven shaft. The 'shrink disc' is a friction device, without keys, which exerts an external clamping force on the hollow output shaft, thus establishing a mechanical shrink fit between the gear unit hollow shaft and driven shaft. 'Shrink disc' capacities have ample margins in dealing with transmitted torques and external loading imposed on gear units.

WORKING PRINCIPLE

The 'shrink disc' consists of a locking collar, a tapered inner ring and locking screws. By tightening the locking screws, the locking collar and tapered inner ring are pulled together, exerting radial forces on the inner ring, thus creating a positive friction connection between hollow shaft and driven shaft.

As the tapered surfaces of locking collar and inner ring are lubricated with Molykote 321R or similar and the taper angle is not self locking, locking collar will not seize on the inner ring and can be released easily when removal is necessary.

When the shrink disc is clamped in position the high contact pressures between tapered surfaces and screw heads and their seatings ensure hermetic sealing and eliminate the possibility of fretting corrosion.

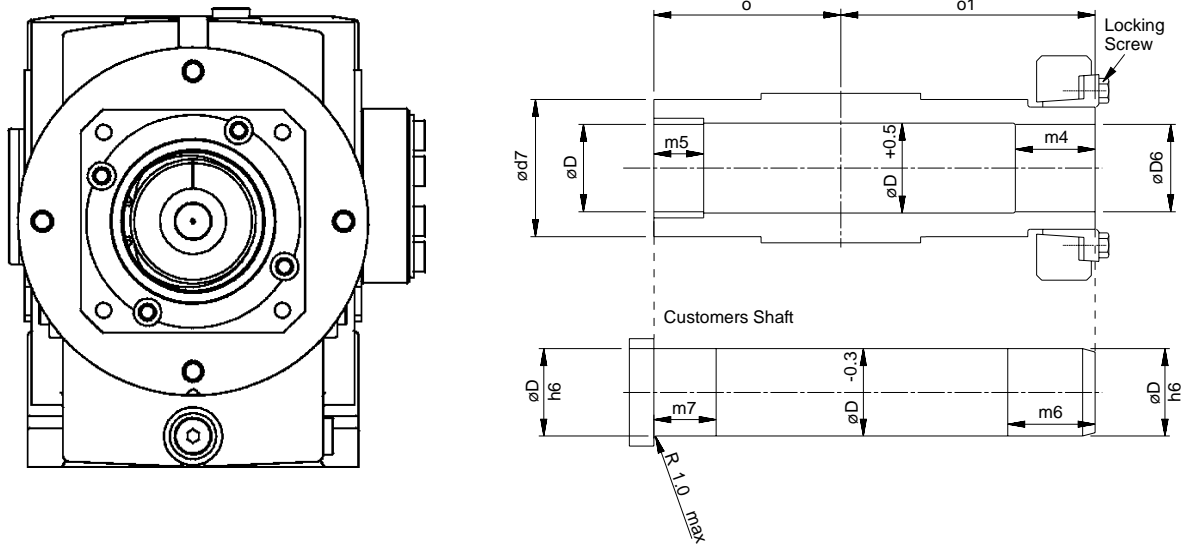

Note: Only available as standard in this handing, please contact us for opposite handing

SIZE	D	D6	d7	f4	g4	m4	m5	m6	m7	o	o1	w7	Locking Screws Torque Ta (lbf.in)
K03	1.181	1.181	1.97	0.10	3.48	1.22	0.79	1.42	0.98	2.36	3.39	3.58	257
K04	1.378	1.378	2.17	0.10	4.25	1.26	0.79	1.46	0.98	2.95	4.02	4.45	257
K05	1.575	1.575	2.36	0.12	4.25	1.42	0.79	1.61	0.98	3.27	4.41	4.65	257
K06	1.575	1.575	2.76	0.14	5.24	1.50	0.79	1.69	0.98	3.54	4.65	5.51	257
K07	1.969	1.969	3.15	0.24	5.24	1.42	1.18	1.61	1.38	4.13	5.35	5.98	310
K08	2.559	2.559	3.54	0.20	6.38	1.61	1.57	1.81	1.77	4.72	6.34	6.89	515

0503

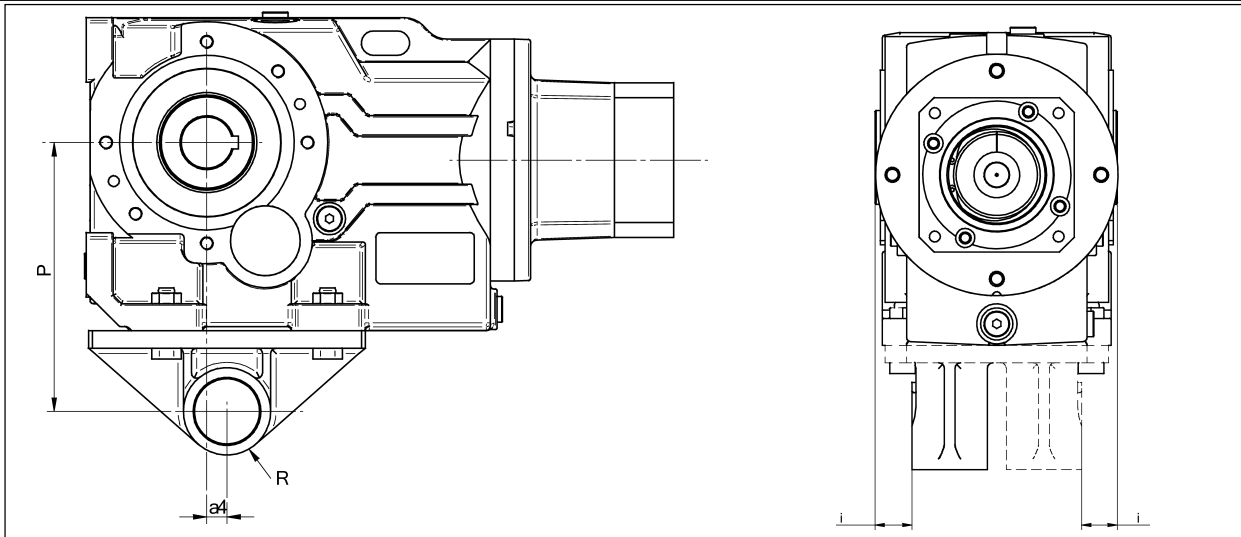

Column 9 Entry

T Torque bracket on left

Column 9 Entry

Q Torque bracket on right

The torque arm requires a Stirrup type anchoring

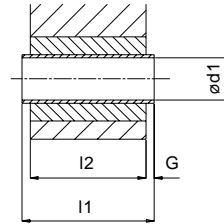
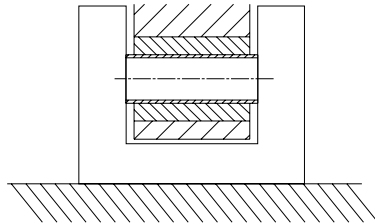

SIZE	a4	d1	G	i	l1	l2	P	R
K03	0.93	0.413 0.406	0.08	0.79	1.42	1.26	5.51	0.79
K04	1.18	0.413 0.406	0.08	0.79	1.42	1.26	6.30	0.79
K05	1.57	0.650 0.642	0.08	0.71	2.36	2.20	7.56	1.38
K06	1.77	0.650 0.642	0.08	0.98	2.36	2.20	7.87	1.38
K07	2.07	0.650 0.642	0.08	0.98	2.36	2.20	9.84	1.38
K08	2.36	0.994 0.974	0.20	1.18	3.15	2.76	11.81	1.57

NOTES:

It is recommended that the torque arm is fitted on the side of the unit adjacent to the driven machine.

The use of a fitted bolt is recommended.

0503

STANDARD UNIT WITH B5 (D) FLANGE

Sizes K09 to K12

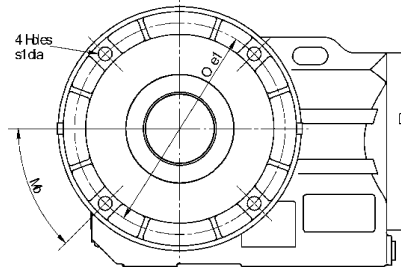

Sizes K03 to K08

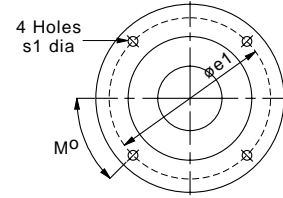

Column 9 Entry

F B5 (D) Output Flange on Left

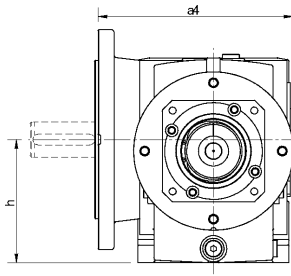

Column 9 Entry

H B5 (D) Output Flange on Right

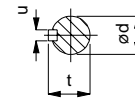
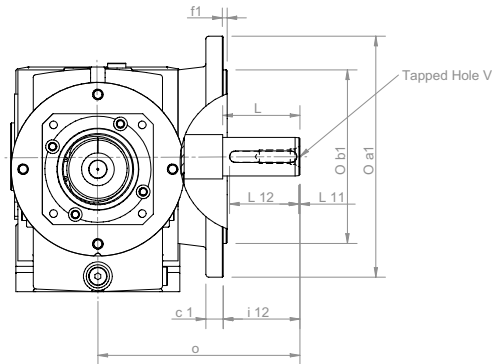

Output Shaft

Flange units are supplied as standard with an extended output shaft
Column 11 Entry **G**

SIZE	Øa1	a4	Øb1	c1	Øe1	f1	h	m	Øs1
K03	6.30	5.67	4.33 j6	0.39	5.12	0.14	3.94	45°	0.35
K04	7.87	7.48	5.12 j6	0.47	6.50	0.14	4.41	45°	0.43
K05	9.84	7.44	7.09 j6	0.63	8.46	0.16	5.20	45°	0.55
K06	9.84	8.66	7.09 j6	0.63	8.46	0.16	5.51	45°	0.55
K07	11.81	9.72	9.06 j6	0.71	10.43	0.16	7.09	45°	0.55
K08	13.78	11.22	9.84 h6	0.71	11.81	0.20	8.35	45°	0.71

SIZE	Inch Extended Output Shaft - Column 11 Entry G							
	d	i2	L	L12	o	t	u	v
K0332	1.0000 / 0.9995	1.97	1.97	1.57	5.28	1.106	0.25	3/8 UNF x 0.75" Deep
K0432	1.2500 / 1.2495	2.36	2.36	1.97	6.89	1.359	0.25	1/2 UNF x 1.13" Deep
K0532	1.3750 / 1.3745	2.76	2.76	2.36	6.93	1.507	0.3125	5/8 UNF x 1.5" Deep
K0632	1.625 / 1.624	3.15	3.15	2.76	8.27	1.784	0.375	5/8 UNF x 1.5" Deep
K0732	2.000 / 1.999	3.94	3.94	3.15	9.53	2.228	0.50	5/8 UNF x 1.5" Deep
K0832	2.375 / 2.374	4.72	4.72	3.94	11.22	2.65	0.625	3/4" 16 UNF x 1.65 Deep

0503

ASSEMBLY ONTO SHAFT - CUSTOMERS SHAFT DETAIL

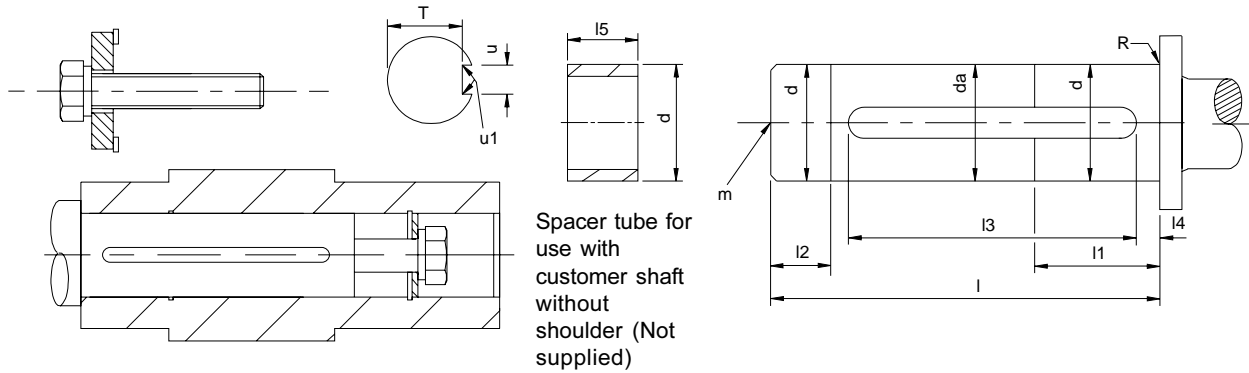

SIZE	d	da	l	l1	l2	l3	l4	l5	m	N	R	T	u	u1
K03	1.2496	1.23	3.23	1.77	0.59	3.00	0.12	0.91	3/8 x UNF	12 lb.ft	0.03	1.112	0.2520	0.010
	0.875 deep								1.106			0.2500		
K04	1.3746	1.36	4.29	2.36	0.79	3.56	0.12	0.91	1/2 x UNF	15 lb.ft	0.03	1.201	0.3145	0.010
	1.3740								1.195			0.3125		
K05	1.4996	1.48	4.41	2.36	0.79	3.63	0.12	1.18	5/8 x UNF	35 lb.ft	0.03	1.289	0.3770	0.010
	1.4990								1.283			0.3750		
K06	1.4996	1.48	4.96	2.95	0.98	4.00	0.12	1.18	5/8 x UNF	35 lb.ft	0.03	1.289	0.3770	0.010
	1.4990								1.283			0.3750		
K07	1.9996	1.98	6.02	3.54	1.18	5.00	0.12	1.18	5/8 x UNF	35 lb.ft	0.03	1.718	0.5020	0.020
	1.9990								1.712			0.5000		
K08	2.3746	2.35	6.81	3.54	1.18	5.00	0.12	1.45	3/4 x UNF	60 lb.ft	0.03	2.021	0.6270	0.020
	2.3739								2.006			0.6250		

Assembly Instructions

1. Spray the hollow shaft bore and mating diameter of the output shaft with Rocol DFMS or equivalent anti-scuffing spray.
2. Fit key into shaft.
3. Fit the circlip into the output sleeve.
4. Fit the spacer tube only if the output shaft has no shoulder, then fit the output shaft into the output sleeve.
5. Secure in place with the washer and bolt. Torque tighten to the values stated in column N of the above table.

0503

DISASSEMBLY METHOD FROM SHAFT

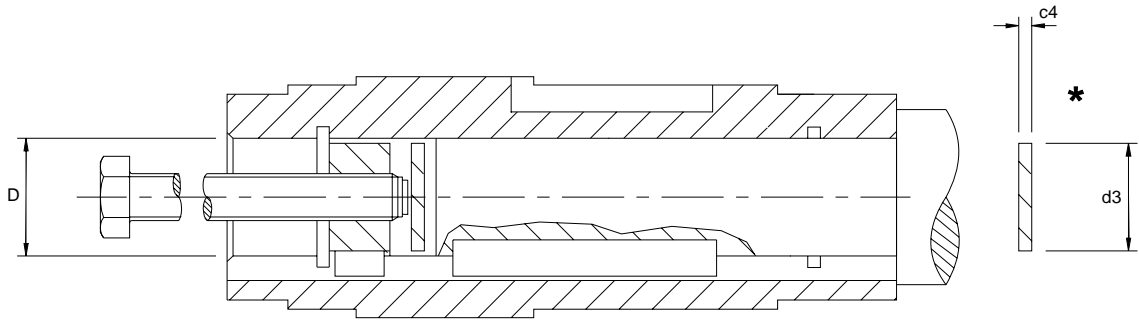

* PARTS SUPPLIED BY CUSTOMER

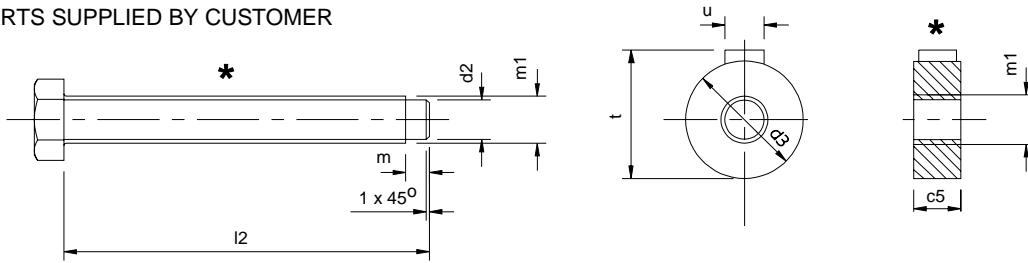

SIZE	c4	c5	D	d2	d3	l2	m	m1	t (max)	u (max)
K03	0.20	0.59	1.250	0.50	1.245	6.00	0.20	5/8 UN	1.35	0.250
K04	0.20	0.59	1.375	0.50	1.370	6.00	0.20	5/8 UN	1.50	0.3125
K05	0.20	0.79	1.500	0.81	1.495	7.00	0.20	1.0 UN	1.65	0.3750
K06	0.20	0.79	1.500	0.81	1.495	7.00	0.20	1.0 UN	1.65	0.3750
K07	0.20	0.79	2.000	0.81	1.995	8.50	0.20	1.0 UN	2.20	0.500
K08	0.31	0.94	2.375	1.00	2.370	10.00	0.20	1.25 UN	2.63	0.625

0503

K03, K04 & K08

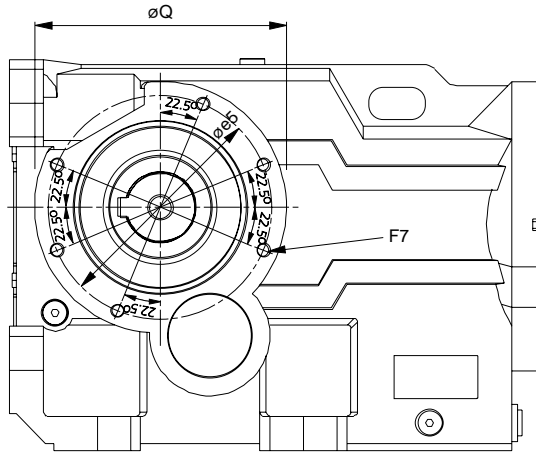

K05

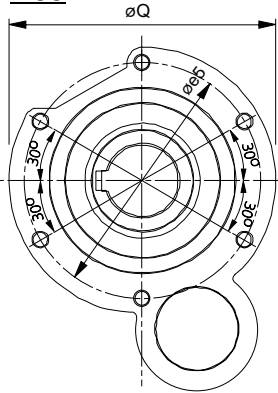

K06

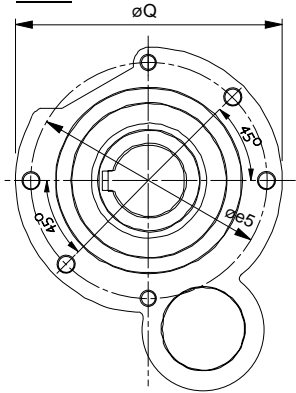

K07

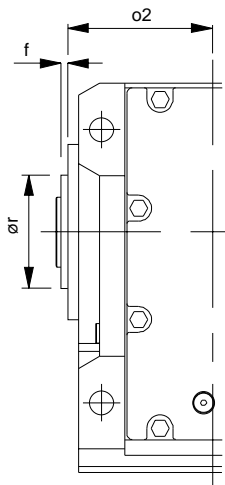
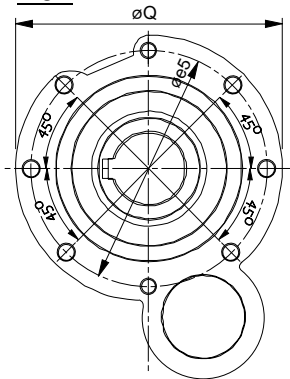

Male spigot
K03 - K07

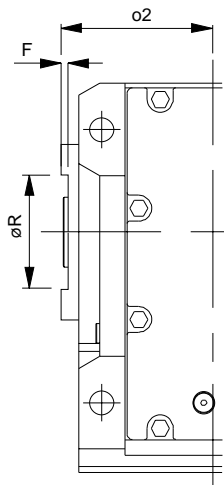

Female recess
K08

SIZE	øe5	F7	ø2	øQ	ør (h7) spigot ø	øR (H7)	Spigot f	Recess F
K03	4.21	6 Holes M8 x 1.25, 0.47 Deep	2.17	4.80	3.346	-	0.10	-
K04	5.12	6 Holes M8 x 1.25, 0.47 Deep	2.76	5.75	4.134	-	0.10	-
K05	4.92	6 Holes M10 x 1.5, 0.67 Deep	2.95	5.91	4.134	-	0.12	-
K06	5.91	6 Holes M10 x 1.5, 0.67 Deep	3.27	7.09	5.118	-	0.14	-
K07	5.91	8 Holes M10 x 1.5, 0.67 Deep	3.74	7.09	5.118	-	0.24	-
K08	7.68	6 Holes M12 x 1.75, 0.79 Deep	4.53	8.66	-	5.906	-	0.20

0503

		K03	K04	K05	K06	K07	K08
Emergency stop							
Maximum radial load							
triple reduction	lb.	300	400	500	600	700	800
	N	1335	1779	2224	2669	3114	3559
Maximum axial load							
triple reduction	lb.	300	400	500	600	700	800
	N	1335	1779	2224	2669	3114	3559
Operating temperature		212 °F					
		100 °C					
Degree of protection		IP55					
Lubrication		EP 320 Gear Oil					
triple reduction	lb.in/arcmin	10	10	10	10	10	10
	N/arcmin	44	44	44	44	44	44
Maximum input speed	rpm	3000	3000	3000	3000	3000	3000
Maximum continuous input speed	rpm	2000	2000	2000	2000	2000	2000
Unit weight (Base Mount)							
triple reduction	lb.	29	49	49	60	86	163
	Kg	13.2	22.3	22.3	27.3	39.1	74.1
Unit weight (Flange Mount)							
triple reduction	lb.	29	49	49	60	86	163
	Kg	13.2	22.3	22.3	27.3	39.1	74.1

0503

IMPORTANT

Product Safety Information

General - The following information is important in ensuring safety. It **must** be brought to the attention of personnel involved in the selection of power transmission equipment, those responsible for the design of the machinery in which it is to be incorporated and those involved in its installation, use and maintenance.

Our power transmission equipment will operate safely provided it is selected, installed, used and maintained properly. As with any power transmission equipment **proper precautions must** be taken as indicated in the following paragraphs, to ensure safety.

Potential Hazards - these are **not** necessarily listed in any order of severity as the degree of danger varies in individual circumstances. It is important therefore that the list is studied in its entirety:

- 1) Fire/Explosion
 - (a) Oil mists and vapour are generated within gear units. It is therefore dangerous to use naked lights in the proximity of gearbox openings, due to the risk of fire or explosion.
 - (b) In the event of fire or serious overheating (over (over 570 °F (300 °C)), certain materials (rubber, plastics, etc.) may decompose and produce fumes. Care should be taken to avoid exposure to the fumes, and the remains of burned or overheated plastic/rubber materials should be handled with rubber gloves.
- 2) Guards - Rotating shafts and couplings must be guarded to eliminate the possibility of physical contact or entanglement of clothing. It should be of rigid construction and firmly secured.
- 3) Noise - High speed gearboxes and gearbox driven machinery may produce noise levels which are damaging to the hearing with prolonged exposure. Ear defenders should be provided for personnel in these circumstances. Reference should be made to state and federal regulations for reducing exposure of employed persons to noise.
- 4) Lifting - Where provided (on larger units) only the lifting points or eyebolts must be used for lifting operations (see maintenance manual or general arrangement drawing for lifting point positions). Failure to use the lifting points provided may result in personal injury and/or damage to the product or surrounding equipment. Keep clear of raised equipment.
- 5) Lubricants and Lubrication
 - (a) Prolonged contact with lubricants can be detrimental to the skin. The manufacturer's instruction must be followed when handling lubricants.
 - (b) The lubrication status of the equipment must be checked before commissioning. Read and carry out all instructions on the lubricant plate and in the installation and maintenance literature. Heed all warning tags. Failure to do so could result in mechanical damage and in extreme cases risk of injury to personnel.
- 6) Electrical Equipment - Observe hazard warnings on electrical equipment and isolate power before working on the gearbox or associated equipment, in order to prevent the machinery being started.
- 7) Installation, Maintenance and Storage
 - (a) In the event that equipment is to be held in storage, for a period exceeding 6 months, prior to installation or commissioning, we must be consulted regarding special preservation requirements. Unless otherwise agreed, equipment must be stored in a building protected from extremes of temperature and humidity to prevent deterioration.
The rotating components (gears and shafts) must be turned a few revolutions once a month (to prevent bearings brinelling).
 - (b) External gearbox components may be supplied with preservative materials applied, in the form of a "waxed" tape overwrap or wax film preservative. Gloves should be worn when removing these materials. The former can be removed manually, the latter using white spirit as a solvent.
Preservatives applied to the internal parts of the gear units do not require removal prior to operation.
 - (c) Installation must be performed in accordance with the manufacturer's instructions and be undertaken by suitably qualified personnel.
 - (d) Before working on a gearbox or associated equipment, ensure that the load has been removed from the system to eliminate the possibility of any movement of the machinery and isolate power supply. Where necessary, provide mechanical means to ensure the machinery cannot move or rotate. Ensure removal of such devices after work is complete.
 - (e) Ensure the proper maintenance of gearboxes in operation. Use only the correct tools and our approved spare parts for repair and maintenance. Consult the Maintenance Manual before dismantling or performing maintenance work.
- 8) Hot Surfaces and Lubricants
 - (a) During operation, gear units may become sufficiently hot to cause skin burns. Care must be taken to avoid accidental contact.
 - (b) After extended running the lubricant in gear units and lubrication systems may reach temperatures sufficient to cause burns. Allow equipment to cool before servicing or performing adjustments.
- 9) Selection and Design
 - (a) The driving and driven equipment must be correctly selected to ensure that the complete machinery installation will perform satisfactorily, avoiding system critical speeds, system torsional vibration, etc.
 - (b) The equipment must not be operated in an environment or at speeds, powers, torques or with external loads beyond those for which it was designed.
 - (c) As improvements in design are being made continually the contents of this catalog are not to be regarded as binding in detail, and drawings and capacities are subject to alterations without notice.

The above guidance is based on the current state of knowledge and our best assessment of the potential hazards in the operation of the gear units.

Any further information or clarification required may be obtained by contacting our Application Engineers.

Contact Textron Fluid & Power

AUSTRALIA

David Brown Gear Industries Ltd
13-19 Franklin Avenue
Bulli, NSW 2516
Australia
Tel: +61 2 4283 0300
Fax: +61 2 4283 0333

AUSTRIA

Benzler Antriebstechnik Ges mbH
Tel: +43 7 229 618 91
Fax: +43 7 229 618 84

BELGIUM

SA David Brown Sadi Benzlers NV
Tel: +32-13661085
Fax: +32-13662337

CHINA

Textron Power Transmission China
Room 601 Lippo Plaza
No. 222 Huai Hai Zhong Rd
Shanghai 200021
China
Tel: +86 21 53966 555
Fax: +86 21 53966 913

DENMARK

Benzler Transmission A/S
Tel: +45 36 34 03 00
Fax: +45 36 77 02 42

FINLAND

Oy Benzler AB
Tel: +358 9 8870 630
Fax: +358 9 8870 631

FRANCE

Benzlers & David Brown Transmissions
Tel: +33 (0)4 72 79 48 33
Fax: +33 (0)4 72 79 48 39

GERMANY

Benzler Germany
Tel: 0800 350 40 00
Fax: 0800 350 40 01

ITALY

Benzler Ferri SpA
Via F.lli Rosselli 16
IT 42019 Scandiano (RE)
Italy
Tel: +39 05 22 763314
Fax: +39 05 22 981758

NETHERLANDS

Northern European Service Centre & HQ Benzlers Netherlands
Postbox 3303
NL 5902 Venlo RH
Netherlands
Tel: +31 773 245 900
Fax: +31 773 245 901

NORWAY

David Brown Hydraulics Norway A/S
PO Box 73 Leirdal
Stromsveien 372
NO- 1008 Oslo, Norway
Tel: +47 22 90 94 30
Fax: +47 22 90 94 11

PHILIPPINES

David Brown John Welsh Custom Build P/L
No 5 Guada Sanchez Street
BF Resort Village
Talon Dos, Las Pinas City 1740
Philippines
Tel: +63 2 874 1194
Fax: +63 2 874 1216

SOUTH AFRICA

David Brown Gear Industries Ltd
PO Box 540, Benoni 1500
South Africa
Tel: +27 11 748 0000
Fax: +27 11 421 2963

SWEDEN

AB Benzlers
PO Box 922
SE-251 09 Helsingborg
Sweden
Tel: +46 42 18 6820
Fax: +46 42 21 8803

THAILAND

David Brown (Thailand) Ltd
700/43 Moo 6
Amatanakorn Industrial Estate
Khong Tam Ru
Muang, Chonburi 20000
Thailand
Tel: +66 38 459 044
Fax: +66 38 743 484

UNITED KINGDOM

David Brown Engineering Ltd
Park Road
Lockwood, Huddersfield
West Yorkshire, HD4 5DD
Tel: +44 (0) 1484 465 610
Fax: +44 (0) 1484 465 586

USA

Cone Drive Textron
240 East 12th Street
Traverse City
MI 49684
USA
Tel: +1 231 946 8410
Fax: +1 231 933 8600

AGRICULTURE

ENERGY

PULP & PAPER

AUTOMOTIVE

FOOD & BEVERAGE

QUARRYING

CEMENT

FORESTRY

RUBBER &
PLASTICS

CHEMICAL

MARINE

TEXTILES

CONSTRUCTION

METALS

TRANSPORTATION

DEFENCE

MINING

WATER

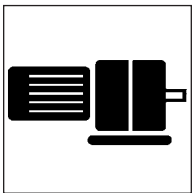

Geared motors

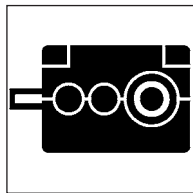

Industrial reducers

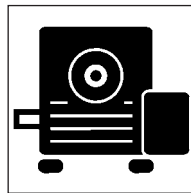

Worm

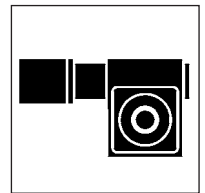

Precision products

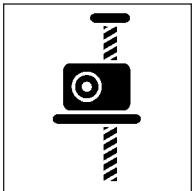

Screwjacks

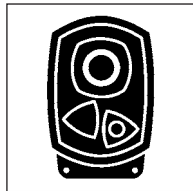

Shaftmount

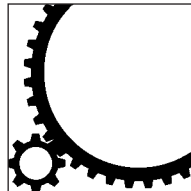

Horizontal mill drives

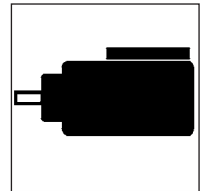

Vertical mill drives

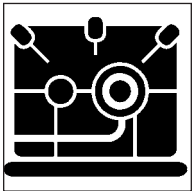

High speed

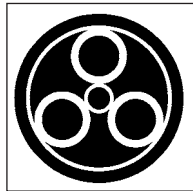

Planetary units

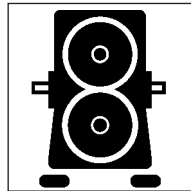

Specialist drives

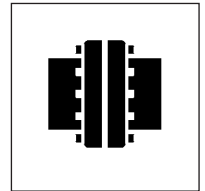

Couplings



Defence Systems

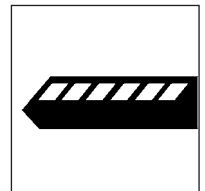
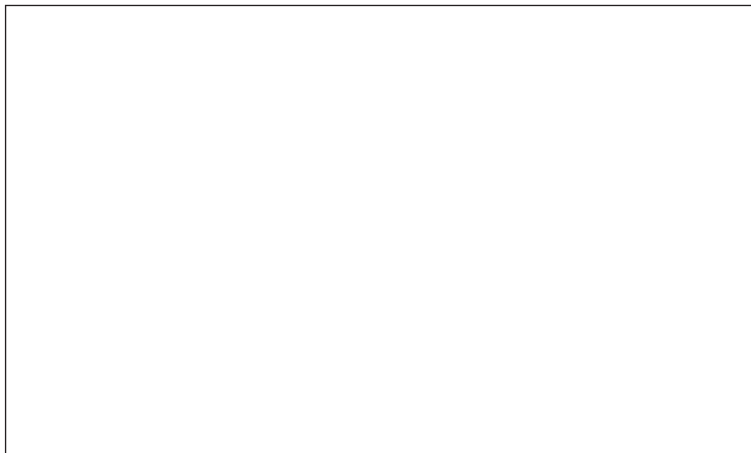

Rail