

where the world turns for couplings

Lovejoy[®]

Specialty Products

In This Section:

- Deltaflex
- Uniflex
- Saga
- Rigid Sleeve
- Shaft Collars



SP

where the world turns for couplings

Lovejoy[®]

Specialty Products

Safety Warning

When using Lovejoy products, you must follow these instructions and take the following precautions. Failure to do so may cause the power transmission product to break and parts to be thrown with sufficient force to cause severe injury or death.

Refer to this Lovejoy Catalog for proper selection, sizing, horsepower, torque range, and speed range of power transmission products, including elastomeric elements for couplings. Follow the installation instructions included with the product, and in the individual product catalogs for proper installation of power transmission products. Do not exceed catalog ratings.

During start up and operation of power transmission product, avoid sudden shock loads. Coupling assembly should operate quietly and smoothly. If coupling assembly vibrates or makes beating sound, shut down immediately, and recheck alignment. Shortly after initial operation and periodically thereafter, where applicable, inspect coupling assembly for: alignment, wear of elastomeric element, bolt torques, and flexing elements for signs of fatigue. Do not operate coupling assembly if alignment is improper, or where applicable, if elastomeric element is damaged, or worn to less than 75% of its original thickness.

Do not use any of these power transmission products for elevators, man lifts, or other devices that carry people. If the power transmission product fails, the lift device could fall resulting in severe injury or death.

For all power transmission products, you must install suitable guards in accordance with OSHA and American Society of Mechanical Engineers Standards. Do not start power transmission product before suitable guards are in place. Failure to properly guard these products may result in severe injury or death from personnel contacting moving parts or from parts being thrown from assembly in the event the power transmission product fails.

If you have any questions, contact the Lovejoy Engineering Department at 1-630-852-0500.

where the world turns for couplings



Specialty Products

Table of Contents

	Running Page No.	Section Page No.
Overview.....	304	SP-4
Deltaflex > Overview	305	SP-5
Deltaflex Types > Overview	308	SP-8
Deltaflex Types > Selection Process	309	SP-9
Application Service Factors > Selection Process	310	SP-10
Deltaflex HP / Torque Ratings > Performance Data	311	SP-11
Deltaflex Type 1 > Dimensional Data	312	SP-12
Deltaflex Type 2 and 2A > Dimensional Data	313	SP-13
Deltaflex Type 3 and 4 > Dimensional Data	314	SP-14
Deltaflex Delta and Round Hub > Dimensional Data	316	SP-16
Uniflex > Overview	317	SP-17
Uniflex > Selection Process.....	318	SP-18
Uniflex > Performance Data	319	SP-19
Uniflex > Dimensional Data	320	SP-20
Uniflex RRU and UF Type > Dimensional Data.....	321	SP-21
Uniflex UFH Type > Dimensional Data.....	322	SP-22
Saga > Overview	323	SP-23
Saga > Performance / Dimensional Data	324	SP-24
Rigid Sleeve > Dimensional Data	325	SP-25
Shaft Collars Zinc / Stainless > Selection / Dimensional Data	326	SP-26
Shaft Collars One-Piece > Selection / Dimensional Data.....	327	SP-27
Shaft Collars Two-Piece > Selection / Dimensional Data.....	328	SP-28

SP

Deltaflex

The patented Deltaflex series of couplings offer maximum misalignment capabilities with negligible reactionary load, for longer equipment life. This all-metal flex-link coupling requires no lubrication or other maintenance. Typical applications include: compressors, pumps, fans, positioning devices, indexing tables, mixers, papermill roll drives, drive line shafts, turbine drives, wind tunnels, cooling towers, and single bearing generator drives.



Deltaflex

Uniflex

This single piece coupling series solves a variety of application concerns, including high misalignment, space limitations, high temperature and exceptionally low backlash/windup. Typical applications include textile equipment, printing and binding registration, robotics/positioning, conveyors, carton folding and gluing equipment, machine tools, centrifugal pumps, agricultural machinery, blowers and winding machines.



Uniflex

Saga

The Saga series of couplings offer lower torsional stiffness than any other rubber-in-compression coupling. There is no equal for high shock start/stop applications such as many piston-driven devices, compressors, violent pounding, or crushing units.



Saga

Rigid Sleeve

Our Rigid Sleeve couplings are suitable for use in joining any two shafts when flexibility is not required. Consisting of a one piece sleeve, the coupling slips onto the ends of the two shafts and is held in place by two set screws. This coupling is best suited for light to medium-duty applications.



Rigid Sleeve

Shaft Collars

A shaft collar limits the range of travel allowed along the shaft by motor bases, machine tools, and other such items. The precision-machined collars offer ease of installation and the best possible holding strength.



Shaft Collars



WARNING

You must refer to page SP-2 (Page 302) for Important Safety Instructions and Precautions for the selection and use of these products. Failure to follow the instructions and precautions can result in severe injury or death.

Deltaflex Coupling Design

The Deltaflex coupling is the real solution to installation, misalignment, and performance problems. Conventional couplings – even when carefully aligned to the manufacturer’s specifications – cannot match the low level of vibration, moment of inertia, and additional cushion for future misalignment of a visually aligned Deltaflex coupling.

In addition, the Deltaflex coupling gives longer life to equipment shaft bearings. That means longer operating time and reduced maintenance cost. The Deltaflex can handle greater shaft misalignment without generating heavy reaction loads on the equipment shaft bearings.

A properly applied and installed Deltaflex coupling offers more equipment protection compared to conventional couplings.

Features

- Maximum misalignment capabilities, with negligible reactionary load, for longer equipment bearing life. (see illustrations A, B and C)
- Operates as smoothly when misaligned as when perfectly aligned
- No lubrication and no maintenance required
- Equipment can be visually aligned. No special tools are required, which saves on installation time and cost
- Eliminates premature equipment bearing and seal failure resulting from misalignment forces. This means greater equipment productivity
- Torsionally stiff coupling with no backlash means it is capable of high speed applications, within catalog ratings
- Provides long-term performance and economy
- Available in 5 basic sizes, from 10HP to 900HP
- Standard all-metal and stainless steel versions are both available from stock. Many configurations are available, including shaft-to-shaft, spacer, floating shaft, and special assemblies



Type 1 Deltaflex

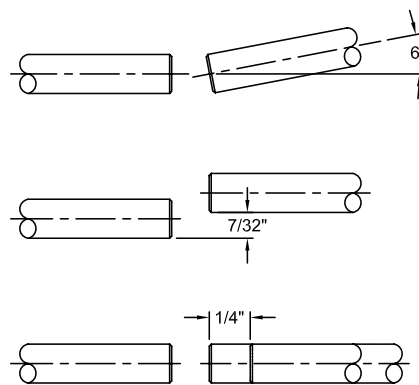

Illustration A
 Misalignment Capability (Size 60 Illustrated)

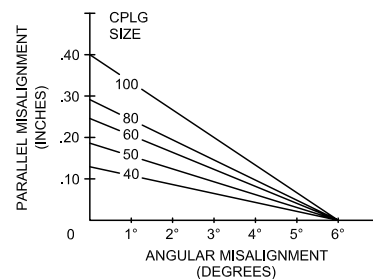

Illustration B
 Standard Series

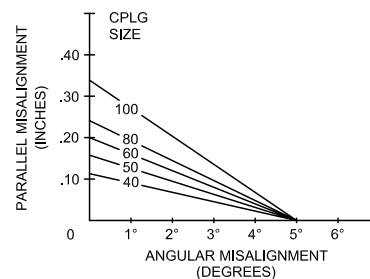

Illustration C
 HT Series

Note: ■ Illustrations B and C assume no axial displacement.

Deltaflex Coupling Design

As graphs A and B clearly illustrate, radial load placed on the shaft bearings of the connected equipment by conventional couplings can substantially reduce bearing life and induce detrimental vibration. If the misaligned coupling creates a radial load – as can be the case with conventional couplings – then nearly 75% of B-10 bearing design life is sacrificed. By using the Deltaflex coupling, B-10 life remains close to 100% of design life, even at maximum misalignment.

Because the Deltaflex coupling is designed for infinite fatigue life at maximum angular misalignment – at rated torque – inadvertent misalignment caused by temperature expansion, equipment frame flexing, foundation movement, environment, etc. will not shorten the life of the coupling or life of the connected equipment.

Patented Design Concept***

The concept of the Deltaflex coupling and its misalignment capabilities can be illustrated best when compared to conventional coupling design (see Graphs C and D). Most conventional couplings' torque and misalignment capabilities are dependent upon a single flexing member. Soft elastomers are limited by the compressive or tensile strengths of the material. Misalignment is a function and limitation of the material properties and method of connection to the hubs.

While other all-metal flexible couplings share the advantage of high torque transmission and better temperature and corrosion resistance, they are typically limited to less than 1/2° angular with less than 0.005 inch parallel misalignment. Approaching or exceeding these limits will exert undesired radial loads and vibration on the connected equipment.

Note: ■ *** U.S. Patent Number: 4033144.

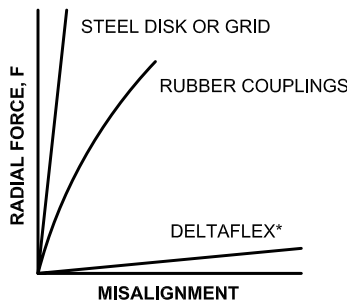

Graph A

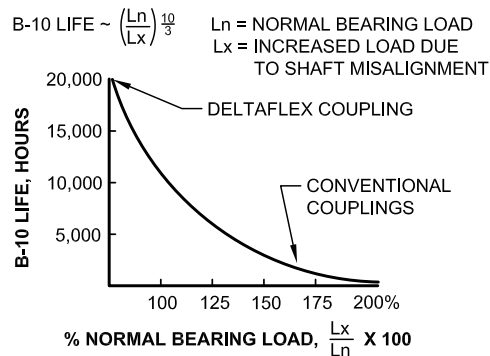

Graph B

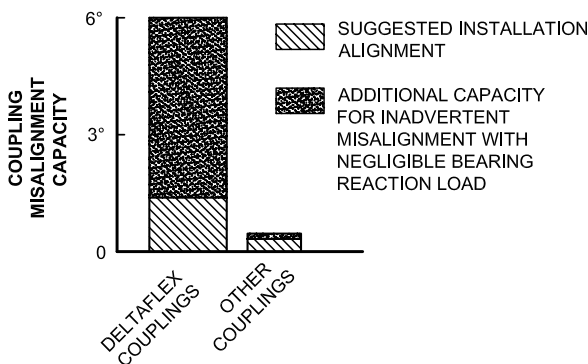

Graph C

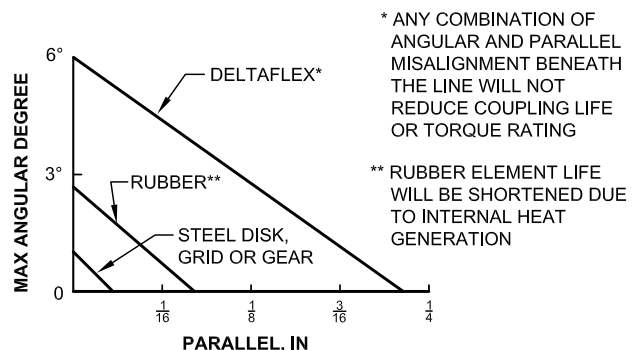

(See illustrations B & C on the previous page for specific sizes)

Graph D

Deltaflex Coupling Design

The Deltaflex Difference

In contrast to most conventional coupling designs (see illustration D), the patented Deltaflex coupling is typically arranged in this manner: a hub, a flex-link at each end of a torque sleeve, and a hub (see illustration E). While most conventional coupling designs use a central flexing element, the Deltaflex uses two, making it a double engaging coupling. The patented concept, along with the method of connecting the hubs to the flexible links, permits the tremendous misalignment capabilities without exerting harmful radial loads.

The Deltaflex coupling consists of four major components: two delta hubs, an inner flange, and an outer flange. The flex-links, as well as the delta mounting plates, are integral to each flange and are factory assembled. The hub is field-assembled to the flange with three axial cap screws. The two flanges are fastened together radially as the two coupling halves are joined to make a complete coupling.

In understanding the design of the Deltaflex it is important to note that the inner and outer flanges, once firmly fastened together with three cap screws, become a rigid "torque sleeve." The flex links at each end of the torque sleeve accommodate the misalignment generated by the equipment shaft hubs.

Typical Deltaflex Applications

Use Deltaflex couplings to simplify installation and minimize fabrication costs of structural frames. With the large misalignment capability of Deltaflex, extremely close tolerances will be unnecessary. Typical applications include: compressors, pumps, fans, mixers (vertical and horizontal), turbine drives, wind tunnels, and single bearing generator drives. Some other applications include:

Drive-Line – Connecting long shaft lines with Deltaflex takes advantage of angular and parallel misalignment capabilities. Permits ease of installation and reduces radial bearing loads to a minimum.

Indexing Table or Work Positioning Drive – Takes advantage of zero backlash, instant response and constant velocity. Coupling may be between drive motor and gear reduction or on output side of reducer.

Cooling Tower Drive – The Deltaflex floating shaft coupling permits greater ease of installation with its generous axial misalignment capabilities. Also available in stainless steel.



Deltaflex

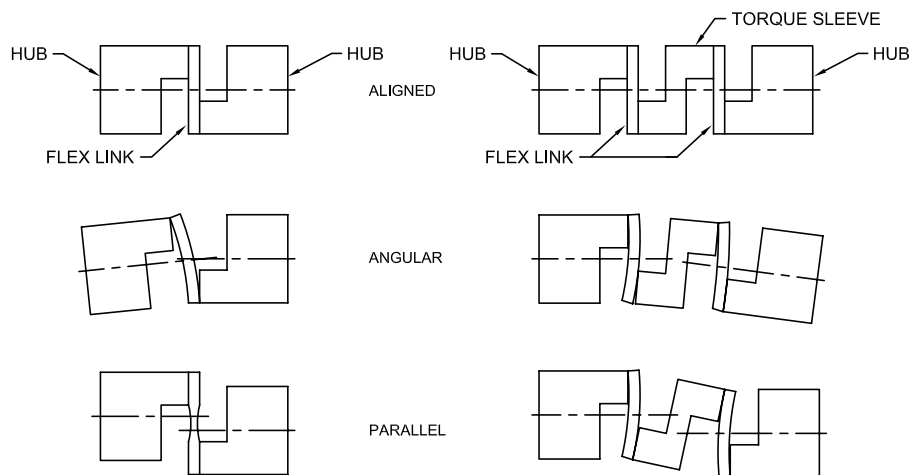
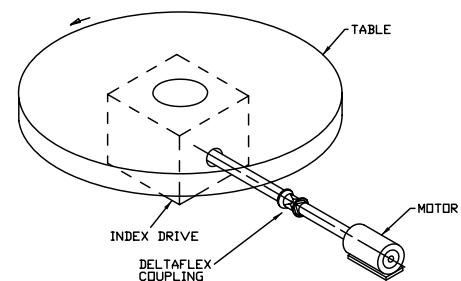
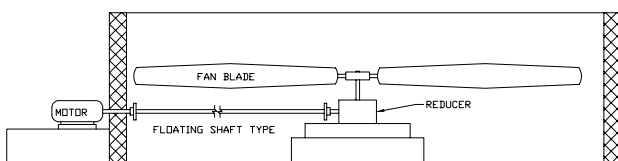

Illustration D
Conventional Coupling

Illustration E
Deltaflex Coupling



Indexing Table



Cooling Tower Drive

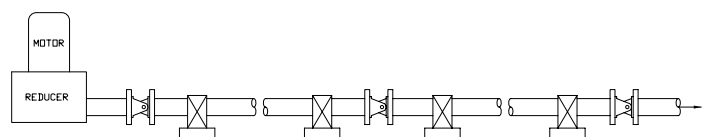

Drive-Line

SP

Deltaflex Coupling Types

The unique design, misalignment capability and simple installation methods make Deltaflex easily adaptable to special applications. Contact Lovejoy Engineering for assistance.

Type 1

Shaft to Shaft – Hubs Mounted Internally

This is the standard arrangement for most shaft to shaft applications. There are five basic coupling sizes in all types, each with a Standard and a High Torque (HT) Series. Both the Standard and the HT Series are dimensionally interchangeable.



Type 1 Arrangement

Type 2

Shaft to Shaft – Hubs Mounted Externally

This arrangement is similar to Type 1 in that all components are the same, except the delta hubs are mounted outside the flanges.



Type 2 Arrangement

Type 2A

Shaft to Shaft – One Hub Mounted Externally,

This arrangement uses the same components as the Type 2, but with one hub mounted on the inside of the flange and one hub mounted on the outside.



Type 2A Arrangement

Type 3

Spacer Type

This arrangement is specifically designed for the pump industry. It is available in a variety of industry standard shaft separations. The shaft center spacer drops out to facilitate easier maintenance of pump parts without disturbing the alignment of pump and motor.



Type 3 Arrangement

Type 4

Floating Shaft Type

Type 4 coupling components are the same as Type 3, except that the floating shaft design uses a longer spacer tube to span distances up to 12 feet. Deltaflex floating shaft couplings are light weight, dynamically balanced (as required) and corrosion resistant, which makes them ideal for applications in cooling towers and petrochemical service.



Type 4 Arrangement



Steps In Selecting A Deltaflex Coupling

Step 1: Determine the proper service factor (SF) for the application. This may involve 2 steps:

- A. Driven equipment service factor (SFa): Using the Application Service Factors Chart 1 (page SP-10) select the service factor which best corresponds to your application. If the application is not listed in Chart 1, use Chart 2.
- B. When using Chart 1, add the following service factors (SFb) to the values in Chart 1 as required. Add 0.5 for above average torque load variations or start/stop conditions of not more than once per hour. Add 1.0 for reversing loads, start/stop conditions more than once per hour, severe torque load variations or high inertia starting conditions.

The additional service factor is added to the Chart 1 service factors to obtain the total service factor.

$$SF = SFa + SFb$$

Step 2: Calculate the equivalent HP/100 RPM.

$$HP/100 \text{ RPM} = \frac{HP^* \times 100 \times SF}{RPM^*}$$

* HP and RPM of prime mover.

Step 3: Select the Deltaflex size.

Method 1: From the Deltaflex HP and Torque Ratings Chart 3 (page SP-11) select the smallest coupling which is rated equal to or higher than the calculated HP/100 RPM.

Method 2: For couplings driven by standard electric motors, you can multiply the HP of the motor by the service factor (SF) and then refer to the electric motor driven chart for selection.

Step 4: Determine the type of Deltaflex needed, e.g., Type 1, Type 2, etc.

Step 5: Check limiting conditions.

- A. Check to be sure that the coupling's Peak Overload Torque Rating is sufficient to accommodate the maximum torque to be transmitted, such as the starting and stall torques of the motor, braking torques and cyclic peak torques, if any. If starting or braking cycles are frequent, the brake torque should be checked against the maximum continuous torque rating of the coupling.

$$T = Tp \times SF$$

T = Maximum torque transmitted

Tp = Brake torque, starting torque or peak torque

SF = Service Factor (determined previously)

- B. Check the maximum hub bore. If bore size is too large, the next larger size Deltaflex can be specified.
- C. Check other dimensions such as the limits on shaft separation, hub spacings, space required for the coupling, etc.
- D. Check maximum speed. If operating speed exceeds 60% of listed maximum speed, the coupling should be dynamically balanced.

Step 6. Ordering Information.

- A. Quantity, size, style of couplings.
- B. Bore and Keyway sizes.
- C. Dynamic balancing specification, if required.
- D. Additional non-standard data.
 - 1) Custom mounting dimensions
 - 2) Between shaft ends (BE) dimension for spacer and floating shaft types
 - 3) Maximum operating speed for floating shaft couplings

Selection Examples

A centrifugal fan requires 20 HP, 1,150 RPM motor, direct coupled from the motor to the fan. The motor frame is 286T (1.875 inch shaft) and the fan shaft is 1.625 inches.

Step 1: Using the Application Service Factors Chart 1 (page SP-10), the driven equipment service factor for a centrifugal fan is 1.5 = SFa. The load is uniform and the driver is smooth, therefore SFb is 0.

The total service factor SF is 1.5 + 0 = 1.5

Step 2: $HP/100 \text{ RPM} = \frac{20 \times 100 \times 1.5}{1,150} = 2.6 \text{ HP/100 RPM}$

Using the Deltaflex HP and torque ratings Chart 3 (page SP-11), under the column of HP/100RPM, the smallest coupling you can select is #50 which is rated for 3.0 HP/100 RPM.

NOTE: You can also find the coupling size by multiplying

$$SF \times 20:$$

$$SF \times 20 = 1.5 \times 20 = 30 \text{ HP}$$

In Chart 3 (page SP-11) for motor drives the coupling to select is, again, #50 under 1,150 RPM motors. The size is rated at 34 HP @ 1,150 RPM.

Step 3: In this case, the maximum bore for size #50 coupling is 1.875 inches; therefore, the selection size stands.

Step 4: Since this is a shaft-to-shaft application, you will be using the standard Deltaflex coupling Type 1. Determine if any other selection factors apply as described in steps 4 and 5 of the selection guide.

Floating Shaft Type Coupling Selection Example

Using the preceding data, assume that the shaft spacing from end of shaft to end of shaft is 36 inches. A floating shaft coupling is then required. The 36 inch is specified as BE (Between Ends) = 36 inches.

Refer to the Type 3 and 4 Chart (page SP-14) to find the overall length of the coupling; add dimension 2 x LTB to BE.

For a size #50 type 3, the overall length will be 36 inches + 2 x 1.69 = 39.38. Note that the length of the spacer tube assembly will be 36 inches - 2R = 36 - 1.62 = 34.38.

This is the amount of space, or dropout section, between the fixed portions of the coupling.



Specialty Products

Application Service Factors

Selection Process

Application Service Factors

Chart 1

Agitators	Edgar Feed	3.0	Calenders.....	3.0
Liquids.....	Live Rolls.....	3.0	Cylinders.....	3.0
Variable Density	Log Haul—Incline.....	3.0	Dryers.....	3.0
Blowers	Log Haul—Well Type	3.0	Jordans	3.0
Centrifugal.....	Planer Feed Chains	3.0	Log Haul.....	3.0
Lobe.....	Planer Floor Chains	3.0	Presses.....	3.0
Vane.....	Planer Tilting Hoist.....	3.0	Suction Roll.....	3.0
Car Dumpers	Slab Conveyor	2.5	Washers and Thickeners	2.5
Car Pullers	Sorting Table	2.5	Winders.....	3.0
Clay Working Machinery	Trimmer Feed.....	3.0	Printing Presses	2.5
Compressors	Machine Tools		Pumps	
Centrifugal.....	Bending Roll.....	3.0	Centrifugal	
Lobe, Vane, Screw	Punch Press—Gear Driven.....	3.0	General Duty (Liquid).....	1.5
Reciprocating—	Tapping Machines.....	4.0	Boiler Feed.....	1.5
Multi-cylinder.....	Auxiliary Drives	2.5	Slurry (Sewage, etc.)	2.5
Not Recommended	Metal Mills		Dredge	3.0
Conveyors—Uniformly Loaded Or Fed	Draw Bench—Carriage	3.5	Reciprocating	
Conveyors—Heavy Duty	Draw Bench—Main Drive.....	3.5	Double Acting.....	Not Recommended
Not Uniformly Fed.....	Forming Machines	3.5	Single Acting	Not Recommended
Conveyors—Vibratory	Slitters.....	3.0	Rotary—Gear, Lobe, Vane.....	2.0
Cranes and Hoists	Table Conveyors		Rubber Industry	
Not Recommended	Non-Reversing.....	3.5	Mixer—Banbury	4.0
Crushers	Reversing.....	4.0	Rubber Calender.....	3.0
Extruders	Wire Drawing & Flattening Machine.....	3.0	Rubber Mill (2 or more).....	3.5
Plastic.....	Wire Winding Machine.....	3.0	Sheeter.....	3.0
Metal.....	Mills, Rotary Type		Tire Building Machines.....	3.5
Fans	Ball.....	3.5	Tubers and Strainers.....	3.0
Centrifugal.....	Cement Kilns.....	3.0	Screens	
Axial.....	Dryers & Coolers.....	3.0	Rotary—Stone or Gravel.....	2.5
Mine Ventilation.....	Kilns.....	3.0	Traveling Water Intake	2.5
Cooling Towers.....	Pebble.....	3.0	Vibratory	3.5
Light Duty Blowers & Fans.....	Rod.....	3.0	Sewage Disposal Equipment	2.5
Feeders	Tumbling Barrels.....	3.0	Textile Industry	
Light Duty.....	Mixers		Batchers.....	2.5
Heavy Duty	Concrete Mixers.....	3.0	Calenders.....	3.0
Food Industry	Drum Type.....	3.0	Card Machines.....	2.5
Cereal Cooker.....	Oil Industry		Dry Cans.....	3.0
Dough Mixer.....	Chillers.....	2.5	Dryers.....	2.5
Meat Grinder.....	Oil Well Pumping.....	3.0	Dyeing Machinery	2.5
Can Filling Machine	Rotary Kilns.....	3.0	Looms.....	2.5
Bottling.....	Paper Mills		Mangles.....	2.5
Generators	Barker Auxiliaries, Hydraulic	4.0	Soapers.....	2.5
Non-Welding	Barker Mechanical	4.0	Spinners.....	2.5
Welding.....	Barker Drum (Spur Gear Only).....	4.0	Windlass	3.0
Hammer Mills	Beater & Pulper.....	3.0		
Lumber Industry	Bleacher.....	2.5		
Barkers—Drum Type				

Notes: ■ Typical Service Factors Electric Motor and Turbine Driven Equipment.
 ■ If people are transported, Lovejoy does not recommend and will not warranty the use of the coupling.

Service Factors for Driven Equipment Load Classifications

Chart 2

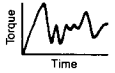
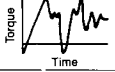
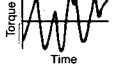
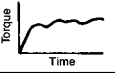
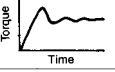
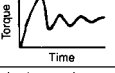
Load Characteristics Service Factors		Load Characteristics Service Factors	
	Shock loads and above average torque load variations, or start/stop applications of up to once per hour.	3.0	
	Heavy shock loads reversing or start/stop applications of more than once per hour or high inertia starting loads.	4.0	
	Heavy reversing torque loads. NOT RECOMMENDED BECAUSE OF LOAD CARRYING METHOD IN FLEXIBLE LINKS	NR	
			
			Relatively low inertia, smooth continuous torque load.
			
			Torque load varies during operation of the equipment.
			
			Above average torque load variations during operation of the equipment.
			* Torque load reversal can exist without reversing rotation and can be caused by overrunning the load with inertia or shifting of the load. Consult Lovejoy Engineering.

Note: ■ * indicates: Torque load reversal can exist without reversing rotation and can be caused by overrunning the load with inertia or shifting of the load. Consult Lovejoy Engineering.



Specialty Couplings

Deltaflex HP / Torque Ratings

Performance Data

Deltaflex HP and Torque Ratings

Chart 3

Size	Max Bore				Maximum Continuous Torque		Peak Overload Torque		HP/100 RPM	HP Rating ¹ @ Standard Motor RPM			
	Delta Hub		Round Hub							in-lbs	Nm	in-lbs	Nm
	in	mm	in	mm									
40	1.38	35	1.63	42	750	84	1,125	127	1.2	10.5	13.8	21.0	42
40HT	1.38	35	1.63	42	1,260	142	1,890	213	2.0	17.5	23.0	35.0	70
50	1.88	50	2.25	58	1,900	214	2,850	322	3.0	26.2	34.0	52.4	105
50HT	1.88	50	2.25	58	2,835	320	4,235	478	4.5	39.0	52.0	78.0	156
60	2.50	66	3.00	81	4,100	463	6,150	695	6.5	57.0	75.0	114.0	228
60HT	2.50	66	3.00	81	6,000	678	9,000	1 017	9.5	83.0	109.0	166.0	332
80	3.38	93	4.00	110	9,500	1 073	14,250	1 610	15.0	131.0	173.0	262.0	524
80HT	3.38	93	4.00	110	15,000	1 695	22,500	2 542	23.8	208.0	274.0	416.0	832
100	4.25	114	5.00	136	22,900	2 587	34,500	3 898	36.3	317.0	418.0	634.0	1,268
100HT	4.25	114	5.00	136	33,000	3 728	49,500	5 593	52.4	458.0	603.0	916.0	1,832

Note: ■ 1 indicates: The HP ratings listed are for drives with a Service Factor of 1.0. Refer to Chart 1 (page SP-10) for Application Service Factors. Further, the ratings are based on prime movers such as electric motors or turbines.

$$\text{HP/100RPM} = \frac{\text{HP} \times 100}{\text{RPM}}$$

$$T(\text{Torque}) = \frac{\text{HP} \times 63,025}{\text{RPM}}$$

$$\text{HP} = \frac{T \times \text{RPM}}{63,025}$$

Note: ■ Internal Combustion Engines: Deltaflex couplings are not recommended for direct connection to internal combustion engine drives.

SP

Type 1

Shaft to Shaft – Hubs Mounted Internally

This is the standard arrangement for most shaft to shaft applications. There are five basic coupling sizes in all types, each with a Standard and a High Torque (HT) Series. Both the Standard and the HT Series are dimensionally interchangeable.

Type 1 features the standard inner and outer flanges and delta hubs, which are triangular in shape to accommodate the delta flex-link pattern. The standard flanges are stamped steel, while the flex links in all Deltaflex couplings are precipitation-hardened (PH 17-7) stainless steel. Delta hubs are ductile iron, zinc clear dichromate-plated and available from stock in a variety of bore sizes. Every Deltaflex hub is standard with two set screws at 120°. Hub to flange (axial) and flange to flange (radial) hardware is SAE Grade 5. Stainless steel flanges with standard ductile iron delta hubs are available from stock as an option. Delta style hubs are not available in stainless steel.

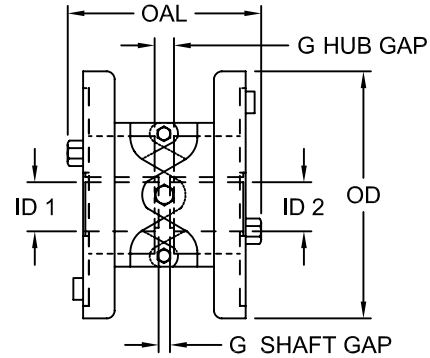

Deltaflex Type 1 Dimensional Data

Size	OAL in	G Hub Gap in	ID1 - ID2				G Shaft Gap in	OD in	HP/100 RPM	Max Continuous Torque		Peak Overload Torque ²		Angular ³	Parallel ³	Axial Freedom ⁴	Moment of Inertia WR ² lbs-in ²	Max RPM ⁵
			Max Bore in	mm	Min RSB ¹ in	mm				in-lbs	Nm	in-lbs	Nm					
40	3.51	0.29	1.375	35	0.438	11	0.12	4.38	1.2	750	85	1,125	127	6°	0.12	0.09	5.4	8,000
40HT	3.54	0.32	1.375	35	0.438	11	0.12	4.38	2.0	1,260	142	1,890	214	5°	0.12	0.09	5.4	8,000
50	4.83	0.71	1.875	48	0.438	11	0.18	6.18	3.0	1,900	215	2,850	322	6°	0.18	0.12	30.1	6,000
50HT	4.87	0.75	1.875	48	0.438	11	0.18	6.18	4.5	2,835	320	4,235	479	5°	0.15	0.12	30.1	6,000
60	6.22	1.23	2.500	64	0.750	19	0.18	7.25	6.5	4,100	463	6,150	695	6°	0.24	0.15	64.3	5,000
60HT	6.26	1.27	2.500	64	0.750	19	0.18	7.25	9.5	6,000	678	9,000	1 017	5°	0.21	0.15	64.3	5,000
80	7.52	1.02	3.375	86	1.375	35	0.25	9.62	15.0	9,500	1 074	14,250	1 610	6°	0.29	0.18	297.0	4,000
80HT	7.57	1.07	3.375	86	1.375	35	0.25	9.62	23.8	15,000	1 695	22,500	2 543	5°	0.25	0.18	297.0	4,000
100	9.74	0.58	4.250	108	1.750	44	0.31	12.75	36.3	22,900	2 588	34,500	3 899	6°	0.40	0.25	884.0	3,000
100HT	9.82	0.66	4.250	108	1.750	44	0.31	12.75	52.4	33,000	3 729	49,500	5 594	5°	0.35	0.25	884.0	3,000

- Notes:
- 1 indicates: RSB hubs are furnished with two set screws at 120°, no keyway.
 - 2 indicates: Peak Overload Torque = Torque that can be applied for short periods, such as shock loads, start up, etc.
 - 3 indicates: See illustrations B & C on page SP-5 for combined maximum misalignment.
 - 4 indicates: Axial Freedom is provided only for the purpose of system expansion or due to temperature changes or shaft flotation (such as with sleeve bearing motors).
 - 5 indicates: Balancing is not required below 60% of maximum RPM.

Type 2

Shaft to Shaft – Hubs Mounted Externally

This arrangement is similar to Type 1 in that all components are the same, except the delta hubs are mounted outside the flanges. An optional version of the Type 2 uses round hubs mounted externally on both ends or on one end to accommodate larger bore requirements. Type 2 is available as a stock option with stainless steel flanges and stainless steel round hubs. Delta style hubs are not available in stainless steel.

Type 2A

Shaft to Shaft – One Hub Mounted Externally, One Hub Mounted Internally

One hub is mounted on the inside of the flange and one hub is mounted on the outside. Round hubs cannot be mounted on the inside of the coupling. Type 2A is available as a stock option with stainless steel flanges. The internal hub would be ductile iron, while the external hub would be a stainless steel round hub. Delta hubs are not available in stainless steel.

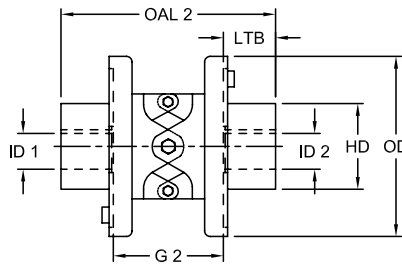

Type 2

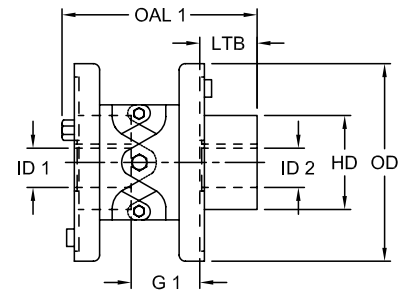

Type 2A

Deltaflex Type 2 and 2A Dimensional Data

Size	OAL1 ² in	OAL2 ² in	LTB in	ID1 - ID2						G1 ³ in	G2 ³ in	OD in	HD in	HP/100 RPM HP	Max Cont Torque		Peak Overload Torque		Max RPM
				Max Bore		Min Bore ¹		in-lbs	Nm						in-lbs	Nm			
				Delta Hub in	Round Hub mm	Delta Hub in	Delta Hub mm												
40	4.51	5.51	1.23	1.375	35	1.625	41	0.438	11	1.67	3.05	4.38	2.56	1.2	750	85	1,125	127	8,000
40HT	4.54	5.54	1.23	1.375	35	1.625	41	0.438	11	1.70	3.08	4.38	2.56	2.0	1,260	142	1,890	214	8,000
50	6.10	7.37	1.57	1.875	48	2.250	57	0.438	11	2.47	4.23	6.18	3.56	3.0	1,900	215	2,850	322	6,000
50HT	6.14	7.41	1.57	1.875	48	2.250	57	0.438	11	2.51	4.27	6.18	3.56	4.5	2,835	320	4,235	479	6,000
60	7.77	9.33	1.90	2.500	64	3.000	76	0.750	19	3.38	5.53	7.25	4.50	6.5	4,100	463	6,250	706	5,000
60HT	7.82	9.37	1.90	2.500	64	3.000	76	0.750	19	3.42	5.57	7.25	4.50	9.5	6,000	678	9,000	1 017	5,000
80	9.58	11.64	2.53	3.375	86	4.000	102	1.375	35	3.80	6.58	9.62	5.88	15.0	9,500	1 074	14,250	1 610	4,000
80HT	9.63	11.69	2.53	3.375	86	4.000	102	1.375	35	3.85	6.63	9.62	5.88	23.8	15,000	1 695	22,500	2 543	4,000
100	12.91	16.08	3.75	4.250	108	5.000	127	1.750	44	4.58	8.58	12.75	7.25	36.3	22,900	2 588	34,500	3 899	3,000
100HT	12.99	16.16	3.75	4.250	108	5.000	127	1.750	44	4.66	8.66	12.75	7.25	52.4	33,000	3 729	49,500	5 594	3,000

- 1 indicates: Minimum Bore hubs are furnished with two set screws at 120°, no keyway.
- 2 indicates: OAL1 is overall length with one hub mounted externally; OAL2 is with both hubs mounted externally.
- 3 indicates: G1 is hub gap with one hub mounted externally; G2 is with both hubs mounted externally.
- For misalignment capabilities, see illustrations B and C on page SP-5, or Type 1 data on previous page. See page SP-11 for Performance Data.

SP

Type 3 Spacer Type

This arrangement is specifically designed for the pump industry and is available in a variety of industry standard shaft separations. The shaft center spacer drops out to facilitate easier maintenance of pump parts without disturbing the alignment of pump and motor. Spacer type couplings utilize either standard delta hubs or optional round hubs. The center member of the Deltaflex is captured by the construction of the spacer flanges for greater safety. Standard spacer drop out lengths are available to accommodate shaft separations of 3.50, 4.38, 5, 7, 10, 12 and 15 inches. Special spacer lengths and stainless steel spacer couplings are available as an option.

Type 4 Floating Shaft Type

The Type 4 coupling components are identical to Type 3, except the floating shaft design uses a longer spacer tube to span distances up to 12 feet. Deltaflex floating shaft couplings are lightweight, dynamically balanced (as required) and corrosion resistant. The center member of the Deltaflex is captured by the construction of the spacer flanges for greater safety. Floating shaft couplings are also available in stainless steel. See next page for dimensions.

Deltaflex Floating Shaft Maximum Parallel Misalignment

Size	Dimensions in Inches at Max Span @ RPM 1750
40	2.50
40HT	2.00
50	3.00
50HT	2.50
60	3.25
60HT	3.00
80	4.00
80HT	3.50
100	4.25
100HT	4.00

Type 3 and 4 – Spacer and Floating Shaft

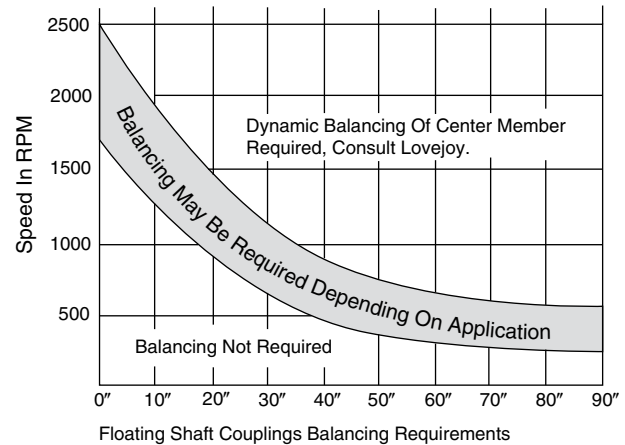
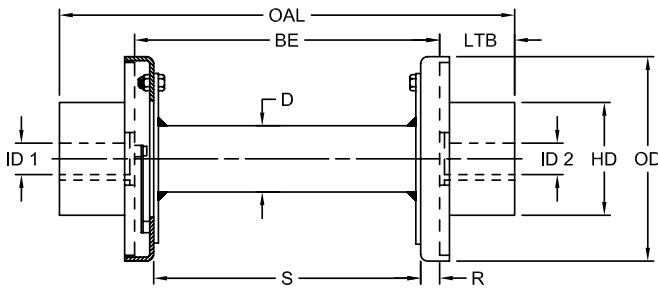

Deltaflex Type 3 and 4 Dimensional Data

Size	OAL in	BE in	LTB ⁴ in	D in	ID1 - ID2				S ³ in	R in	OD in	HD in	HP/100 RPM HP	Max Cont Torque		Peak Overload Torque			
					Min Bore ¹		Max Bore							in-lbs	Nm	in-lbs	Nm		
					Delta Hub in	mm	Delta Hub in	mm										Round Hub in	mm
40	See Type 3 on SP-15	See Type 3 on SP-15	1.34	1.50	0.438	11	1.375	35	1.625	41	See Type 3 on SP-15	0.50	4.38	2.56	1.2	750	85	1,125	127
40HT			1.34	1.50	0.438	11	1.375	35	1.625	41		0.50	4.38	2.56	2.0	1,260	142	1,890	213
50			1.68	2.00	0.438	11	1.875	48	2.250	57		0.81	6.18	3.56	3.0	1,900	215	2,850	322
50HT			1.68	2.00	0.438	11	1.875	48	2.250	57		0.81	6.18	3.56	4.5	2,835	320	4,235	478
60			2.03	2.62	0.750	19	2.500	64	3.000	76		0.94	7.25	4.50	6.5	4,100	463	6,250	695
60HT			2.03	2.62	0.750	19	2.500	64	3.000	76		0.94	7.25	4.50	9.5	6,000	678	9,000	1 017
80			2.66	3.50	1.375	35	3.375	86	4.000	102		1.00	9.62	5.88	15.0	9,500	1 074	14,250	1 610
80HT			2.66	3.50	1.375	35	3.375	86	4.000	102		1.00	9.62	5.88	23.8	15,000	1 695	22,500	2 543
100			3.88	4.38	1.750	44	4.250	108	5.000	127		1.25	12.75	7.25	36.3	22,900	2 588	34,500	3 899
100HT			3.88	4.38	1.750	44	4.250	108	5.000	127		1.25	12.75	7.25	52.4	33,000	3 729	49,500	5 594

- Notes:
- 1 indicates: Minimum bore hubs are furnished with 2 set screws at 120°, no keyway.
 - 3 indicates: S is the Spacer drop out or floating shaft length, S = BE-2(R).
 - 4 indicates: LTB is the length through the hub bore. OAL is the overall length, OAL = BE + 2(LTB).
 - BE is the distance between the ends of equipment shafts—please supply this dimension when placing orders, BE = OAL-2 (LTB), BE = S + 2 (R), BE < 18 inch = Spacer coupling (Type 3); BE > 18 inch = Floating Shaft coupling (Type 4).



Specialty Products

Deltaflex Type 3 and 4

Dimensional Data

Deltaflex Type 3 Additional Dimensional Data

Size	OAL		BE		S	
	in	mm	in	mm	in	mm
40/40HT	6.16	156	3.50	89	2.50	64
	7.03	179	4.38	111	3.38	86
	7.66	194	5.00	127	4.00	102
50/50HT	7.72	196	4.38	111	2.75	70
	8.34	212	5.00	127	3.38	86
	10.34	263	7.00	178	5.38	137
60/60HT	9.06	230	5.00	127	3.12	82
	11.06	281	7.00	178	5.12	130
	14.06	357	10.00	254	8.12	206
80/80HT	15.31	389	10.00	254	8.16	207
	17.31	440	12.00	305	10.16	258
100/100HT	19.75	502	12.00	305	9.50	241
	22.75	578	15.00	381	12.50	318

Deltaflex Type 4 Floating Shaft Coupling Maximum Span-Inch

Size	Max Span-BE		
	1750 RPM	1150 RPM	875 RPM
40/40HT	60	76	88
50/50HT	70	88	102
60/60HT	80	100	114
80/80HT	94	115	140
100/100HT	104	120	150

Note: ■ Consult Lovejoy Engineering for other RPM/Span applications.

SP



Specialty Products

Deltaflex Delta and Round Hub

Dimensional Data

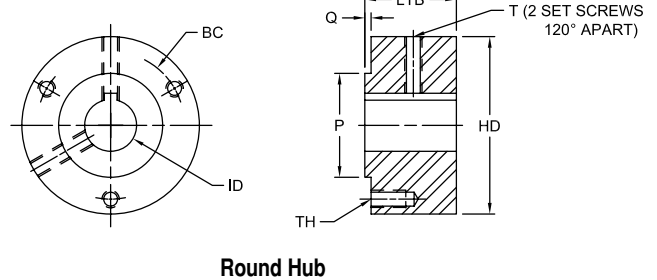
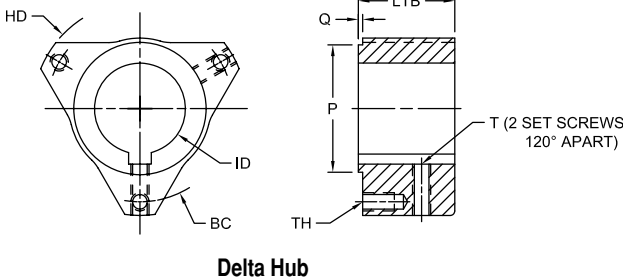

Deltaflex Delta and Round Hub Dimensional Data

Size	HD in	ID						BC in	LTB in	Q in	P in	T Set Screw in	TH Axial Cap Screw Tap in
		Min Bore ¹		Max Bore									
		Delta Hub in	mm	Delta Hub in	mm	Round Hub in	mm						
40/40HT	2.56	0.438	11	1.375	35	1.625	41	2.12	1.34	0.09	1.498/1.500	1/4-20	1/4-20 x .62
50/50HT	3.56	0.438	11	1.875	48	2.250	57	3.08	1.68	0.09	1.998/2.000	1/4-20*	5/16- 18 x .75
60/60HT	4.50	0.750	19	2.500	64	3.000	76	3.88	2.03	0.12	2.623/2.625	3/8-16	3/8- 16 x .88
80/80HT	5.88	1.375	35	3.375	86	4.000	102	5.12	2.66	0.12	3.498/3.500	1/2-13	1/2- 13 x 1.00
100/100HT	7.25	1.750	44	4.250	108	5.000	127	6.32	3.88	0.12	4.373/4.375	1/2-13	5/8- 11 x 1.50

- Notes: ■ * indicates: In some bore sizes the tap is 5/8-18.
 ■ Maximum bores are provided with standard keyway. RSB hubs do not have a keyway. Both Delta hubs and Round hubs are provided with two set screws at 120°.

Deltaflex Standard Bore Availability Chart

Size	0.438	0.625	0.750	0.875	1.000	1.125	1.250	1.375	1.500	1.625	1.750	1.875	2.000
40/40HT	D	S	S	S	S	S	S	S	R	R	N/A	N/A	N/A
50/50HT	D	S	S	S	S	S	S	S	S	S	S	S	R
60/60HT	N/A	N/A	D	S	S	S	S	S	S	S	S	S	S
80/80HT	N/A	N/A	N/A	N/A	N/A	N/A	N/A	D	N/A	S	S	S	S
100/100HT	N/A	N/A	N/A	N/A	N/A	N/A	N/A	N/A	N/A	N/A	D	S	S

Size	2.125	2.250	2.375	2.500	2.625	2.750	2.875	3.000	3.125	3.250	3.375	3.500
50/50HT	R	R	N/A	N/A	N/A	N/A	N/A	N/A	N/A	N/A	N/A	N/A
60/60HT	S	S	S	S	R	R	R	R	N/A	N/A	N/A	N/A
80/80HT	S	S	S	S	S	S	S	S	S	S	S	S
100/100HT	S	S	S	S	S	S	S	S	S	S	S	S

Size	3.625	3.750	3.875	4.000	4.125	4.250	4.375	4.500	4.625	4.750	4.875	5.000
80/80HT	R	R	R	R	N/A	N/A	N/A	N/A	N/A	N/A	N/A	N/A
100/100HT	S	S	S	S	S	S	R	R	R	R	R	R

- Notes: ■ S indicates: Standard hub, finished bores available from stock, two set screws @ 120° and standard keyway.
 ■ R indicates: Round hub, finished bores available from stock, two set screws @ 120° and standard keyway.
 ■ D indicates: Delta hubs, rough stock bores available from stock, two set screws @ 120°, no keyway.
 ■ N/A indicates: Not Available.

Uniflex Coupling Design

Flexible Spring Type Coupling with Exclusive Triple Wound Spring Design

The Uniflex Coupling is an all steel, single piece coupling that solves a variety of application concerns including: high misalignment, space limitations, high temperature, and exceptionally low backlash/windup. The unique flexing center of the Uniflex consists of three opposingly wound square wire springs for forward or reverse operation. Two steel hubs are then brazed to the steel spring pack to create a durable one-piece flexible coupling.

Features

- This designed flexibility compensates for high degrees of shaft misalignment (up to 4.5° angular, up to .045 inches parallel)
- The one piece Uniflex is simple to install – nothing to replace, no wearing parts, and no lubrication needed
- The compact design provides a coupling that is smaller and lighter than most couplings of comparable torque ratings. It is also well suited for applications with inaccessible mounting locations
- All metal design means that the Uniflex can be used in applications where severe environmental concerns are a factor. Standard couplings withstand temperatures to 250° F (due to soldering); special designs to 600° F (stainless steel w/electron beam weld)
- The Uniflex is unaffected by oil, grease, dirt and most industrial chemicals



Uniflex Triple Spring Coupling

Uniflex Coupling Types

Four styles of Uniflex couplings are available: shaft-to-shaft, drop out, flange-to-flange and flange-to-shaft.

U Type

This is a durable one-piece flexible coupling for general purpose shaft-to-shaft applications. It is the basis for all Uniflex coupling types.

RRU Type

This design offers “quick disconnect” for drop out requirements. It can also accommodate a slightly larger shaft diameter than the standard U Type.

UF Type

This flange-to-flange type is designed to connect flange mounted equipment to another flange while compensating for misalignment. It is also the center drop out section of the RRU Type.

UFH Type

A flange-to-shaft configuration, this couples flange mounted equipment to a shaft with all the benefits of Uniflex versatility. The stock flange plate is the same as used on the UF Type.



U Type



RRU Type



UF Type



UFH Type

SP



Uniflex Coupling Selection Process

Once it is determined that the unique features of Uniflex meet your application, selection of the proper coupling depends on three factors: torque transmission, bore requirements, and RPM. When selecting a Uniflex coupling, the torque capability shown as maximum must not be exceeded. Nominal torque adjusted by an application service factor, start up torque, braking torque and any cyclic shock or peak torques inherent in the application must be considered.

Steps In Selecting A Uniflex Coupling

Step 1: Determine the Uniflex type or configuration from page SP-17.

Step 2: Calculate the nominal torque as T or nominal HP/100RPM

$$T = \frac{(HP^* \times 63,025)}{RPM^*} \quad HP/100RPM = \frac{HP^* \times 100}{RPM^*}$$

$$T = \frac{(KW^* \times 9,550)}{RPM}$$

Note: ■ *Usually HP (KW) & RPM of prime mover, if the coupling is to be attached to the prime mover or if no speed or torque devices are between the driver and driven equipment.

Step 3: Determine the application service factor from page JW-8. Multiply the nominal torque by the application service factor to determine the total required torque.

Step 4: Select the size.

Step 5: Check to be sure the peak torque or maximum torque from starting, braking or cyclic peaks does not exceed the coupling maximum capability. For applications involving frequent starts and stops, refer to Lovejoy Engineering. NOTE: Diesel and gasoline engine drives usually require special considerations. Refer to Lovejoy Engineering.

Step 6: a. Check the coupling maximum bore capability versus the shaft to be used. If necessary, pick a larger size coupling to get the needed bore capacity.
b. Check the maximum speed.
c. Check any limiting dimensions.

Selection Example

A rolling device operates at 6,000 RPM and requires 15 HP. The driving shaft is 1.250 inches diameter and the roll shaft is 1.125 inches diameter. Select the proper U type shaft-to-shaft coupling. Occasional emergency stops impose 675 in-lbs of torque, otherwise the operation has no cyclic loading. Start up torque is 1/3 of emergency stopping torque. Rolls of various types typically have a 1.5 - 2.0 application service factor. Determine the nominal torque or HP/100RPM:

Step 1: $T = \frac{15 \times 63,025}{6,000} = 158 \text{ in-lbs}$

$$HP/100 \text{ RPM} = \frac{15 \times 100}{6,000} = 0.25 \text{ HP/100 RPM}$$

Step 2: Determine the Total Rated Torque:

$$Tr = 158 \times 2.0 = 316 \text{ in-lbs}$$

Maximum stopping torque = 675 in-lbs

Start up torque = 225 in-lbs

The U-125 coupling meets all the above requirements with the key item as the maximum stopping torque.

Step 3: The U-125 has a maximum bore capability of 1.250 inches, which covers the application driver shaft of the same size. The roll shaft is 1.125 inches, which is less than maximum.

Note: ■ Uniflex maximum bore sizes includes a standard keyway allowance.

SP



Specialty Product

Uniflex

Performance Data

Uniflex Performance Data

Size	Wind Up At Max Torque ¹	Misalignment Capability								
		Max Angular Offset	Max Parallel Offset		Max Recommended End Play		Max Torque		HP/100 RPM	Max Speed RPM
			in	mm	in	mm	in-lbs	Nm		
18 Reg	1.80°	3.0°	0.008	0.20	0.010	0.25	18	2.0	0.03	30,000
25 Reg	1.80°	4.5°	0.011	0.28	0.020	0.51	34	3.8	0.05	30,000
37 Reg	1.78°	4.5°	0.014	0.36	0.020	0.51	39	4.4	0.06	30,000
50 Reg	1.82°	4.5°	0.021	0.53	0.035	0.89	82	9.3	0.13	30,000
62 Reg	0.85°	3.0°	0.019	0.48	0.035	0.89	126	14.2	0.20	20,000
75 Reg	1.82°	4.5°	0.028	0.71	0.040	1.02	175	19.8	0.28	20,000
87 Reg	1.68°	4.5°	0.035	0.89	0.040	1.02	346	39.1	0.55	10,000
100 Reg	1.03°	3.0°	0.030	0.76	0.040	1.02	565	63.8	0.90	6,000
125 Reg	1.85°	4.5°	0.044	1.12	0.040	1.02	755	85.3	1.21	6,000
137 Reg	1.85°	3.0°	0.035	0.89	0.040	1.02	1,260	142.4	2.02	6,000
150 Reg	0.85°	3.0°	0.041	1.04	0.040	1.02	1,890	213.5	3.02	3,000
25 Short	1.07°	3.0°	0.007	0.18	0.015	0.38	34	3.8	0.05	30,000
37 Short	1.09°	3.0°	0.009	0.23	0.015	0.38	39	4.4	0.06	30,000
50 Short	1.05°	3.0°	0.014	0.36	0.010	0.25	82	9.3	0.13	30,000
62 Short	0.85°	3.0°	0.019	0.48	0.020	0.51	126	14.2	0.20	20,000
75 Short	1.12°	3.0°	0.019	0.48	0.020	0.51	175	19.8	0.28	20,000
87 Short	1.17°	3.0°	0.024	0.61	0.020	0.51	346	39.1	0.55	10,000
100 Short	1.03°	3.0°	0.030	0.76	0.020	0.51	565	63.8	0.90	6,000
125 Short	1.22°	3.0°	0.030	0.76	0.020	0.51	755	85.3	1.21	6,000
137 Short	1.35°	3.0°	0.350	0.89	0.020	0.51	1,260	142.4	2.02	6,000
150 Short	0.85°	3.0°	0.041	1.04	0.020	0.51	1,890	213.5	3.03	3,000

Note: ■ 1 indicates: Total backlash is approximately 1/3 of windup at maximum torque – consult Lovejoy Engineering for more information.

SP



Specialty Product

Uniflex

Dimensional Data

U Type Shaft-to-Shaft

The U Type is the basis for all Uniflex couplings. It is a shaft-to-shaft flexible coupling with a simple one piece design, making it ideal for indexing, robotic or positioning applications. The U Type consists of a triple-wound flexible steel spring brazed to a steel hub at each end. This all steel design ensures optimum equipment protection in severe environments and/or high temperature applications.

Regular and short versions are available for most sizes to accommodate different overall length requirements. Special hub or bore modifications are also possible. These units can be supplied with either pin holes or with keyways and set screws. Lovejoy does not recommend the reboring of uniflex couplings by customers due to potential damage to the brazed joint.



U-Type

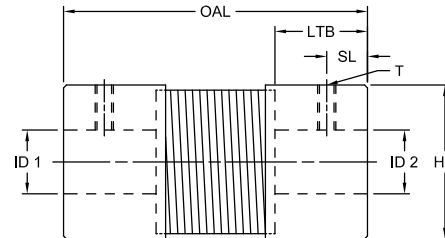

Uniflex U Type Dimensional Data

Size	OAL ¹		LTB		SL		Pin Size	T		ID1 - ID2				HD	Weight			
	Reg	Short	Reg	Short	Pin Location			Set Screw	Per Hub	Qty	Size	Min Bore			Max Bore		lbs	kg
					Reg	Short						in	mm		in	mm		
U-18	1.00	—	0.31	—	0.16	—	3/32	1	6-32	0.125	3	0.250	6	0.61	0.09	0.04		
U-25	1.50	1.00	0.38	0.32	0.16	0.16	3/32	1	6-32	0.125	3	0.313	8	0.73	0.10	0.05		
U-37	2.06	1.65	0.52	0.52	0.25	0.25	3/32	1	10-24	0.250	6	0.375	10	0.86	0.27	0.12		
U-50	2.50	1.82	0.64	0.50	0.31	0.31	1/8	1	1/4-20	0.313	8	0.500	13	1.04	0.36	0.16		
U-62	2.72	2.28	0.84	0.62	0.38	0.38	1/8	1	1/4-20	0.313	8	0.625	16	1.42	0.78	0.35		
U-75	3.31	2.72	0.84	0.84	0.41	0.41	1/8	1	1/4-20	0.375	10	0.750	19	1.42	0.82	0.37		
U-87	3.50	2.91	0.84	0.84	0.44	0.44	3/16	1	1/4-20	0.438	11	0.875	22	1.73	1.40	0.63		
U-100	4.12	3.56	1.29	1.00	0.56	0.56	5/16	1	1/4-20	0.438	11	1.000	25	2.11	2.60	1.18		
U-125	4.88	3.75	1.28	1.10	0.62	0.62	5/16	1	3/8-16	0.625	16	1.250	32	2.17	2.74	1.24		
U-137	5.25	4.12	1.58	1.01	0.69	0.69	3/8	1	3/8-16	0.625	16	1.375	35	2.54	4.00	1.81		
U-150	6.28	5.00	1.88	1.72	0.81	0.81	3/8	1	3/8-16	0.750	19	1.500	38	2.98	8.00	3.63		

Note: ■ 1 indicates: OAL Tolerance + 1/8 inch.

Uniflex U Type - Stainless Steel Dimensional Data

Size	OAL ¹		LTB		SL		Pin Size	T		ID1 - ID2		HD	Weight			
	Reg	Short	Reg	Short	Pin Location			Set Screw	Per Hub	Qty	Size		Max Bore		lbs	kg
					Reg	Short							in	mm		
U-18	0.95	—	0.31	—	0.16	—	3/32	1	6-32	0.250	6	0.60	0.09	0.04		
U-25	—	0.97	—	0.41	—	0.16	3/32	1	6-32	0.313	8	0.62	0.10	0.05		
U-37	—	1.68	—	0.68	—	0.25	3/32	1	10-24	0.313	8	0.75	0.27	0.12		
U-50	—	1.80	—	0.58	—	0.31	1/8	1	1/4-20	0.375	10	0.94	0.36	0.16		
U-62	2.65	2.27	0.96	0.77	0.38	0.38	1/8	1	1/4-20	0.500	13	1.25	0.78	0.35		
U-75	—	2.65	—	0.96	—	0.41	1/8	1	1/4-20	0.500	13	1.25	0.82	0.37		
U-87	—	2.94	—	0.99	—	0.44	3/16	1	1/4-20	0.750	19	1.69	1.40	0.63		
U-100	4.09	3.55	1.41	1.13	0.56	0.56	5/16	1	1/4-20	1.000	25	1.94	2.60	1.18		
U-125	—	3.99	—	1.25	—	0.62	5/16	1	3/8-16	1.000	25	1.97	2.74	1.24		

Note: ■ 1 indicates: OAL Tolerance + 1/8 inch.

RRU Type – Dropout Style

The RRU Type Uniflex coupling is designed for fast, easy installation and removal without disrupting the connected shafts. This is ideal when servicing impellers, bearings and seals.

The design consists of two steel hubs fastened with cap screws to a Uniflex double flange coupling (UF Type). The RRU is easily disassembled by simply removing the cap screws and sliding out the UF center spring section.



RRU Type

UF Type – Flange-to-Flange

This coupling is actually the center dropout section of the RRU Type, but it can be purchased separately for direct flange-to-flange mounting of the driving unit to the driven. The UF Type coupling compensates for high misalignment to protect connected equipment, yet it is also well-suited for applications which require negligible backlash or windup and reliability under high temperature conditions. Stock flange sizes are shown in the Dimensional Data table below, but other sizes can be provided to meet special mounting requirements.

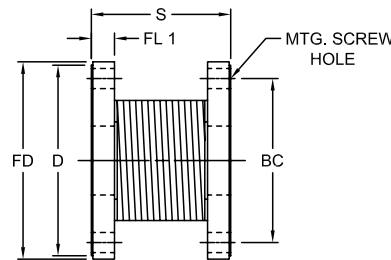
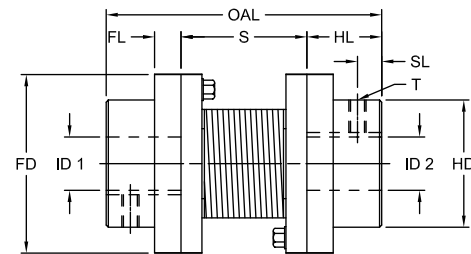

UF Type

Uniflex RRU and UF Type Dimensional Data

Size	HD in	ID1 - ID2				HL in	FL in	FL1 in	OAL ¹ in	D in	FD in	SL Pin Location in	Pin Size in	S ² in	BC in	UF Type Mounting Screw ³		RRU Type Set Screw Per Hub	
		Min Bore in	mm	Max Bore in	mm											Qty	Size	Qty	Size
RRU-50	2.00	0.375	10	1.000	25	1.00	—	0.25	3.52	1.88	2.00	0.50	1/8	1.56	1.50	3	1/4-20	1	1/4-20
RRU-75	2.50	0.375	10	1.250	32	1.25	—	0.38	4.27	2.38	2.50	0.62	1/8	1.81	2.00	3	1/4-20	1	1/4-20
RRU-87	2.87	0.438	11	1.375	35	1.38	—	0.38	4.84	2.75	2.88	0.69	3/16	2.12	2.25	3	1/4-20	1	1/4-20
RRU-100	2.31	0.438	11	1.375	35	1.38	0.50	0.38	4.90	3.12	3.25	0.44	5/16	2.18	2.68	3	5/16-18	1	1/4-20
RRU-125	2.75	0.625	16	1.625	41	1.62	0.50	0.50	5.84	3.56	3.68	0.56	5/16	2.62	3.12	3	5/16-18	1	3/8-16
RRU-137	3.25	0.625	16	1.875	48	1.88	0.50	0.50	6.53	4.25	4.38	0.69	3/8	2.81	3.75	3	3/8-16	1	3/8-16
RRU-150	3.75	0.750	19	2.125	54	2.12	0.62	0.50	7.66	5.00	5.38	0.82	3/8	3.44	4.38	4	3/8-16	1	3/8-16

- Notes:
- 1 indicates: OAL Tolerance $\pm .19$ inch.
 - 2 indicates: UF Center Drop out Length Tolerance $\pm .12$ inch.
 - 3 indicates: Screws not supplied for UF.
 - When ordering specify prefix RRU or UF; dimensions remain the same for either.
 - See page SP-19 for Performance Data.

UFH Type – Flange-to-Shaft

The one-piece UFH Type coupling is similar to the U Type, except that one hub is replaced by a flange plate. Stock flange sizes are shown in the Dimensional Data table below but other sizes can be made to order. As with the other Uniflex styles, this coupling compensates for high degrees of angular and parallel misalignment with very little backlash or windup and is reliable in harsh or severe environments.

Regular and short versions are available for each size to accommodate different overall length requirements. For increased versatility, the hub can be modified with a tapered, spline, hex or square bore. The standard hub is furnished with either a pre-drilled pin hole or with a keyway and set screw. Specify when ordering.



UFH Type

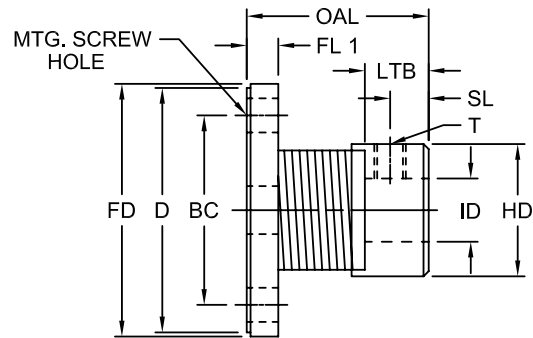

Uniflex UFH Type Dimensional Data

Size	OAL ¹		FL ¹	LTB		SL Pin Location in	Pin Size in	T		ID		HD	FD	D	BC	Mounting Screw ²			
	Reg	Short		Reg	Short			Qty	Size	Min Bore	Max Bore					in	mm	in	mm
UFH-50	2.03	1.50	0.25	0.64	0.50	0.31	1/8	1	1/4-20	0.313	8	0.500	13	1.04	2.00	1.88	1.50	3	1/4-20
UFH-75	2.58	2.00	0.38	0.84	0.84	0.41	1/8	1	1/4-20	0.375	10	0.750	19	1.42	2.50	2.88	2.00	3	1/4-20
UFH-87	2.82	2.25	0.38	0.84	0.84	0.44	3/16	1	1/4-20	0.438	11	0.875	22	1.73	2.88	2.75	2.25	3	1/4-20
UFH-100	3.14	2.88	0.38	1.29	1.00	0.56	5/16	1	1/4-20	0.438	11	1.000	25	2.11	3.25	3.12	2.68	3	5/16-18
UFH-125	3.75	2.82	0.50	1.28	1.10	0.62	5/16	1	3/8-16	0.625	16	1.250	32	2.17	3.68	3.56	3.12	3	5/16-18
UFH-137	4.03	3.46	0.50	1.58	1.02	0.69	3/8	1	3/8-16	0.625	16	1.375	35	2.54	4.38	4.25	3.75	3	3/8-16
UFH-150	4.86	3.75	0.63	1.88	1.72	0.81	3/8	1	3/8-16	0.750	19	1.500	38	2.98	5.38	5.00	4.38	4	3/8-16

- Notes:
- 1 indicates: OAL Tolerance $\pm .12$ inch.
 - 2 indicates: Screws not supplied.
 - See page SP-19 for Performance Data.

Saga Coupling Design

Elastomeric Pre-compression Type

Saga is a general purpose, torsionally soft coupling with high tolerance to all forms of misalignment. The design features hexagonal or octagonal rubber donut-shaped elements with metal inserts positioned at each apex during the vulcanization process. These metal inserts carry actual bolts which fix the element to tines on cast, cylindrical hubs. Embedded inserts also have tines which connect with mating surfaces on hubs so that axial bolts can be easily torqued during assembly without twisting the rubber beyond the limits of its elasticity. The rubber between each apex is precompressed, so it is much more durable to the stresses arising from the various forms of misalignment and torsional vibrations.

While the Saga coupling is normally associated with shaft-to-shaft applications, adaptations for flange and flywheel mountings can be made. In addition, a floating shaft version for use in lieu of a universal joint drive shaft with separate torsional coupling is available. Its elements can also be stacked in series for use in applications with extreme transient or permanent parallel misalignment, or where torsional dynamics demand an extremely soft element for proper damping and/or vibratory decoupling. The rubber's stiffness of 60 as measured against Shore A by durometer, covers the majority of such situations.

Features

- No end thrust in misalignment position
- Absorbs misalignment and shock
- No axial reaction force to damage or accelerate wear in system bearings
- Accepts constant angular misalignment of up to 3°
- Parallel tolerance of 0.060 (1.5mm), while reaction force remains low
- Lateral softness without complication, or sacrifice of performance or durability
- Natural rubber can operate in temperatures from -60° to 200° F (-51° to 93° C)

Note: ■ For applications requiring simultaneous angular and parallel misalignment, consult Lovejoy Engineering to ensure that heat generated from all three forms of stress do not exceed the coupling's ability to dissipate heat.



Saga Type

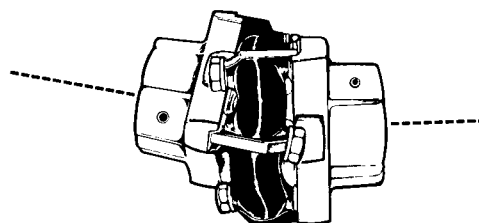

Angular Offset (Exaggerated)

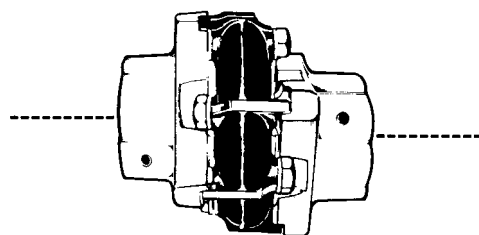

Parallel Offset (Exaggerated)

Steps In Selecting A Saga Coupling

Step 1: Establish torque or HP rating of the driver and operating and maximum RPM (for electric motors, these are essentially the same).

Step 2: Determine the horsepower 100 RPM:

$$\frac{HP \times 100}{RPM} = \text{HP per 100 RPM}$$

or establish driver torque at operating RPM.

Step 3: Using the Application Service Factor table (page JW-8) multiply torque or HP/100 RPM by the factor. Using the result, select a coupling from the Performance Data chart (page SP-24). The coupling's rating must be equal to or greater than adjusted HP/100 RPM or torque.

Step 4: Compare the maximum driver RPM to the Performance Data chart on page SP-24 to insure that the coupling's speed limit is not exceeded.

Step 5: Finally, determine shaft diameters of both driving and driven equipment and check them against maximum bore diameters from the Dimensional Data chart on page SP-24 to ensure that these values are not exceeded.



Specialty Product

Saga

Performance / Dimensional Data

Saga Performance Data

Size	HP/100 RPM for 1.0 Service Factor	Rated Torque for 1.0 SF		Max Shock Load		Dynamic Torsional Stiffness		Specific Torsional Stiffness	Max Speed RPM ¹	Approx Weight		Moment of Inertia WR ² lb in ²
		in-lbs	Nm	in-lbs	Nm	in-lbs/Deg	in-lbs/Rad			lbs	kg	
S-11	0.56	350	40	1,000	113	47	2,693	7.69	10,000	4.75	2.2	3.0
S-13	0.95	600	68	1,800	203	67	3,839	6.40	8,400	6.50	2.9	6.6
S-15	1.59	1,000	113	3,000	339	120	6,875	6.88	7,000	10.00	4.5	14.3
S-18	3.17	2,000	226	6,000	678	200	11,459	5.73	5,600	17.00	7.7	40.0
S-22	4.76	3,000	339	9,000	1 017	400	22,918	7.64	5,000	31.00	14.1	102.0
S-26	7.93	5,000	565	15,000	1 695	590	33,805	6.76	4,000	46.00	20.9	234.0
S-30	11.11	7,000	791	21,000	2 373	800	45,837	6.55	3,500	64.00	29.0	384.0
S-34	19.04	12,000	1 356	36,000	4 067	2,000	114,592	9.55	2,800	122.00	55.3	832.0
S-40	31.73	20,000	2 260	60,000	6 779	3,500	200,535	10.03	2,200	175.00	79.4	1,200.0

Note: ■ 1 indicates: For higher speeds, balancing may be necessary.

Saga Bolt Torque Data

Size	Bolt Grade No 5 Size	Recommended Torque			
		Wet		Dry	
		ft-lb	Nm	ft-lb	Nm
S-11	5/16 - 18 x 1-3/4	13	18	17	23
S-13	3/8 - 16 x 2	23	31	30	41
S-15	3/8 - 16 x 2-1/2	23	31	30	41
S-18	1/2 - 13 x 3	55	75	75	102
S-22	5/8 - 11 x 3-1/4	110	149	150	203
S-26	3/4 - 10 x 4	200	271	260	353
S-30	3/4 - 10 x 4-1/2	200	271	260	353
S-34	3/4 - 10 x 4-1/2	200	271	260	353
S-40	1 - 8 x 5-1/2	480	651	640	868

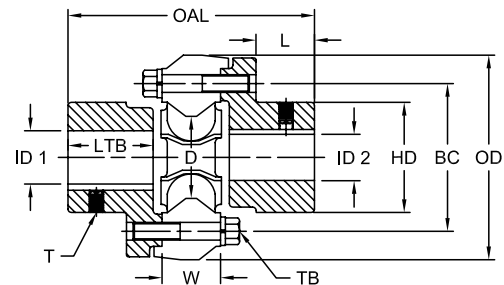

SP

Saga Dimensional Data

Size	OAL in	L in	LTB in	D in	ID1 - ID2				T Set Screw in	TB Bolt Grade No 5 Qty	W in	OD in	BC in	HD in	
					Rough Stock Bore ²		Max Bore								
					in	mm	in	mm							
S-11	4.56	1.13	1.50	1.38	0.625	16	1.188	30	5/16-18	6	5/16 - 18 x 1-3/4	1.06	3.56	2.56	1.84
S-13	5.22	1.31	1.75	1.63	0.750	19	1.375	35	5/16-18	6	3/8 - 16 x 2	1.22	4.28	3.06	2.25
S-15	6.41	1.63	2.13	2.00	0.875	22	1.875	48	3/8-16	6	3/8 - 16 x 2-1/2	1.53	5.09	3.69	2.88
S-18	7.44	1.81	2.50	2.33	1.000	25	2.225	57	1/2-13	6	1/2 - 13 x 3	1.81	6.28	4.56	3.44
S-22	8.69	2.06	3.00	2.75	1.000	25	2.500	64	1/2-13	6	3/8 - 11 x 3-1/4	2.06	7.31	5.20	3.88
S-26	9.88	2.25	3.38	3.25	1.500	38	2.875	73	1/2-13	6	3/4 - 10 x 4	2.38	8.63	6.20	4.59
S-30	11.38	2.75	3.88	3.63	1.625	41	3.375	86	5/8-11	6	3/4 - 10 x 4-1/2	2.63	9.63	6.94	5.31
S-34	12.66	3.44	4.34	4.75	2.125	54	4.000	102	5/8-11	8	3/4 - 10 x 4-1/2	2.95	11.09	8.25	6.25
S-40	14.81	3.88	5.00	6.00	2.250	57	4.750	121	5/8-11	8	1 - 8 x 5-1/2	3.56	13.38	10.00	7.50

Notes: ■ 2 indicates: Standard bores available by 1/16 inch increments.

■ Some metric sizes also available as standard.

Rigid Sleeve Couplings

Lovejoy Rigid Sleeve couplings fit the standards of the industry. These couplings, the simplest type, provide a fixed union between two shafts which are precisely aligned. They are suitable for use in joining any two shafts when flexibility is not required, shaft alignment is maintained and proper bearing support is provided. Bore tolerances are $-.000/+0.002$.



Rigid Sleeve

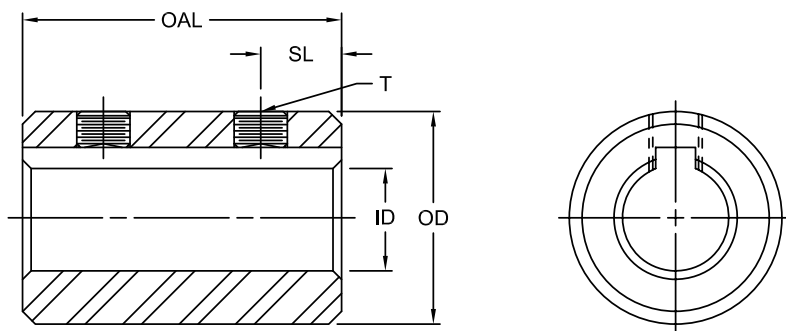

Rigid Sleeve Dimensional Data

Size	UPC Number	OAL in	SL in	T Bolt in	OD in	ID Max Bore	
						in	mm
SC-250	14322	0.75	0.19	8-32 x 1/8	0.50	0.250*	6
SC-312	14324	1.00	0.25	8-32 x 1/8	0.62	0.313*	8
SC-375	14326	1.00	0.25	10-24 x 3/16	0.75	0.375*	10
SC-500	14330	1.50	0.38	1/4-20 x 3/16	1.00	0.500	13
SC-625	14332	2.00	0.50	5/16-18 x 1/4	1.25	0.625	16
SC-750	14335	2.00	0.50	5/16-18 x 5/16	1.50	0.750	19
SC-875	14338	2.00	0.50	5/16-18 x 5/16	1.75	0.875	22
SC-1000	14343	3.00	0.75	3/8-16 x 3/8	2.00	1.000	25
SC-1125	14346	3.00	0.75	3/8-16 x 3/8	2.12	1.125	29
SC-1250	14349	4.00	1.00	3/8-16 x 3/8	2.25	1.250	32
SC-1375	14352	4.50	1.00	3/8-16 x 3/8	2.50	1.375	35

Notes: ■ * indicates: These sizes do not have keyways.

■ When referencing the Lovejoy UPC number in this table, include 685144 as a prefix to the number shown.

SP

Shaft Collars

Zinc Plated and Stainless Steel

Lovejoy shaft collars are precision machined for the best possible fit. Standard steel collars are made from highest quality cold finished steel bar stock and zinc plated for corrosion resistance and outstanding appearance. Stainless steel collars are made from type 303 stainless and include a stainless steel set screw. All Lovejoy shaft collars use socket cup point set screws for ease of installation and best possible holding strength. Made in USA.

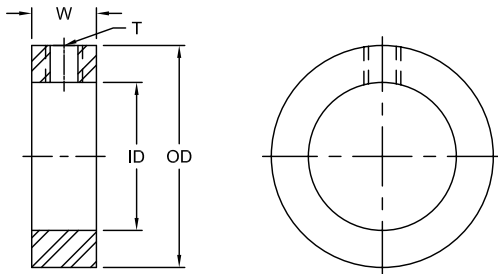

Shaft Collar - Zinc and Stainless Dimensional Data

Size	UPC Number		W in	T Set Screw in	OD in	ID Bore ² in
	Zinc Plated	Stainless				
LSC-2	17507	17557	1/4	6-32 x 1/8	3/8	1/8
LSC-3	17508	17559	1/4	8-32 x 1/8	7/16	3/16
LSC-4	17509	15761	5/16	10-24 x 1/8	1/2	1/4
LSC-5	17510	17563	5/16	10-32 x 3/16	5/8	5/16
LSC-6	17511	17565	3/8	1/4-20 x 3/16	3/4	3/8
LSC-7	17512	17567	7/16	1/4-20 x 1/4	7/8	7/16
LSC-8	17513	17569	7/16	1/4-20 x 1/4	1	1/2
LSC-9	17514	17571	7/16	1/4-20 x 1/4	1	9/16
LSC-10	17515	17573	1/2	5/16-18 x 1/4	1-1/8	5/8
LSC-11	17516	17575	9/16	5/16-18 x 1/4	1-1/4	11/16
LSC-12	17517	17577	9/16	5/16-18 x 1/4	1-1/4	3/4
LSC-13	17518	17579	9/16	5/16-18 x 1/4	1-1/4	13/16
LSC-14	17519	17581	9/16	5/16-18 x 5/16	1-1/2	7/8
LSC-15	17520	17583	9/16	5/16-24 x 1/4	1-1/2	15/16
LSC-16	17521	17585	5/8	5/16-24 x 1/4	1-1/2	1
LSC-17	17522	17587	5/8	5/16-18 x 5/16	1-3/4	1-1/16
LSC-18	17523	17589	5/8	5/16-18 x 5/16	1-3/4	1-1/8
LSC-19	17524	17591	11/16	3/8-16 x 3/8	2	1-3/16
LSC-20	17525	17593	11/16	3/8-16 x 3/8	2	1-1/4
LSC-21	17526	17595	11/16	3/8-16 x 3/8	2-1/8	1-5/16
LSC-22	17527	17597	3/4	3/8-16 x 3/8	2-1/8	1-3/8
LSC-23	17528	17599	3/4	3/8-16 x 3/8	2-1/4	1-7/16
LSC-24	17529	17601	3/4	3/8-16 x 3/8	2-1/4	1-1/2
LSC-25	17530	17603	13/16	3/8-16 x 3/8	2-1/2	1-9/16
LSC-26	17531	17605	13/16	3/8-16 x 3/8	2-1/2	1-5/8
LSC-27	17532	17607	13/16	3/8-16 x 3/8	2-1/2	1-11/16
LSC-28	17533	17609	7/8	1/2-13 x 1/2	2-5/8	1-3/4
LSC-29	17534	17611	7/8	1/2-13 x 1/2	2-3/4	1-13/16
LSC-30	17535	17613	7/8	1/2-13 x 1/2	2-3/4	1-7/8
LSC-31	17536	17615	7/8	1/2-13 x 1/2	3	1-15/16
LSC-32	17537	17617	7/8	1/2-13 x 1/2	3	2
LSC-33	17538	—	7/8	1/2-13 x 1/2	3	2-1/16
LSC-34	17539	17621	7/8	1/2-13 x 1/2	3	2-1/8
LSC-35	17540	—	15/16	1/2-13 x 1/2	3-1/4	2-3/16
LSC-36	17541	17625	15/16	1/2-13 x 1/2	3-1/4	2-1/4
LSC-37	17542	—	15/16	1/2-13 x 1/2	3-1/4	2-5/16
LSC-38	17543	17629	15/16	1/2-13 x 1/2	3-1/4	2-3/8
LSC-39	17544	—	1	1/2-13 x 1/2	3-1/2	2-7/16
LSC-40	17545	17633	1	1/2-13 x 1/2	3-1/2	2-1/2
LSC-41	17546	—	1	1/2-13 x 1/2	3-3/4	2-9/16
LSC-42	17547	—	1-1/8	1/2-13 x 1/2	4	2-5/8
LSC-43	17548	—	1-1/8	1/2-13 x 1/2	4	2-11/16
LSC-44	17549	—	1-1/8	1/2-13 x 1/2	4	2-3/4
LSC-45	17550	—	1-1/8	1/2-13 x 1/2	4	2-13/16
LSC-46	17551	—	1-1/8	1/2-13 x 1/2	4	2-7/8
LSC-47	17552	—	1-1/8	1/2-13 x 1/2	4	2-15/16
LSC-48	17553	—	1-1/8	1/2-13 x 1/2	4	3

Notes: ■ Bore Tolerance LSC-2 through LSC-16, +.003-.000 Bore Tolerance LSC-17 through LSC-48, +.003-.001.
 ■ When referencing the Lovejoy UPC number in this table, include 685144 as a prefix to the number shown.

Shaft Collars

One-Piece

Lovejoy One-Piece split shaft collars are designed to fully engage the shaft without marring or causing other shaft damage. Collars are made from the highest quality bar stock steel and are black oxide finished for corrosion resistance and outstanding appearance. All Lovejoy shaft collars use socket cup point set screws for ease of installation and best possible holding strength.

Features

- Equally effective on both hard and soft shafts
- Made of 12L14 Mild Steel
- Hex Socket, Cup Point, 3A Thread Screws
- Made in the U.S.A.
- Tolerances:

Bore Diameter - +.003, -.000 in

Outside Diameter - +.000, -.015 in

Width - + .015 in

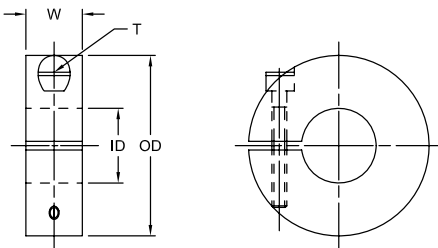

One-Piece Split Shaft Collar

Shaft Collar - One Piece Dimensional Data

Size	UPC Number	W in	T Clamp Screw	OD in	ID Bore in
SC1-2	63200	5/16	4-40 x 3/8	11/16	1/8
SC1-3	63201	5/16	4-40 x 3/8	11/16	3/16
SC1-4	63202	5/16	4-40 x 3/8	11/16	1/4
SC1-5	63203	5/16	4-40 x 3/8	11/16	5/16
SC1-6	63204	3/8	6-32 x 3/8	7/8	3/8
SC1-7	63205	3/8	6-32 x 3/8	15/16	7/16
SC1-8	63206	3/8	6-32 x 3/8	1-1/8	1/2
SC1-9	63207	13/32	8-32 x 1/2	1-5/16	9/16
SC1-10	63208	7/16	10-32 x 1/2	1-5/16	5/8
SC1-11	63209	1/2	10-32 x 1/2	1-1/2	11/16
SC1-12	63210	1/2	1/4-28 x 5/8	1-1/2	3/4
SC1-13	63211	1/2	1/4-28 x 5/8	1-5/8	13/16
SC1-14	63212	1/2	1/4-28 x 5/8	1-5/8	7/8
SC1-15	63213	1/2	1/4-28 x 5/8	1-3/4	15/16
SC1-16	63214	1/2	1/4-28 x 5/8	1-3/4	1
SC1-17	63215	1/2	1/4-28 x 5/8	1-7/8	1-1/16
SC1-18	63216	1/2	1/4-28 x 3/4	1-7/8	1-1/8
SC1-19	63217	1/2	1/4-28 x 3/4	2-1/16	1-3/16
SC1-20	63218	1/2	1/4-28 x 3/4	2-1/16	1-1/4
SC1-21	63219	9/16	1/4-28 x 3/4	2-1/4	1-5/16
SC1-22	63220	9/16	1/4-28 x 3/4	2-1/4	1-3/8
SC1-23	63221	9/16	1/4-28 x 3/4	2-1/4	1-7/16
SC1-24	63222	9/16	1/4-28 x 3/4	2-3/8	1-1/2
SC1-25	63223	9/16	1/4-28 x 3/4	2-3/8	1-9/16
SC1-26	63224	11/16	5/16-24 x 1	2-5/8	1-5/8
SC1-27	63225	11/16	5/16-24 x 1	2-3/4	1-11/16
SC1-28	63226	11/16	5/16-24 x 1	2-3/4	1-3/4
SC1-30	63227	11/16	5/16-24 x 1	2-7/8	1-7/8
SC1-31	63228	5/8	5/16-24 x 1	3	1-15/16
SC1-32	63229	11/16	5/16-24 x 1	3	2
SC1-34	63230	3/4	5/16-24 x 1	3-1/4	2-1/8
SC1-35	63231	3/4	5/16-24 x 1	3-1/4	2-3/16
SC1-36	63232	3/4	5/16-24 x 1	3-1/4	2-1/4
SC1-38	63233	3/4	5/16-24 x 1	3-1/2	2-3/8
SC1-39	63234	3/4	5/16-24 x 1	3-1/2	2-7/16
SC1-40	63235	7/8	3/8-24 x 1-1/4	3-3/4	2-1/2
SC1-42	63236	7/8	3/8-24 x 1-1/4	3-7/8	2-5/8
SC1-43	63237	7/8	3/8-24 x 1-1/4	4	2-11/16
SC1-44	63238	7/8	3/8-24 x 1-1/4	4	2-3/4
SC1-46	63239	7/8	3/8-24 x 1-1/4	4-1/4	2-7/8
SC1-47	63240	7/8	3/8-24 x 1-1/4	4-1/4	2-15/16
SC1-48	63241	7/8	3/8-24 x 1-1/4	4-1/4	3

Note: ■ When referencing the Lovejoy UPC number in this table, include 685144 as a prefix to the number shown.

SP

Shaft Collars

Two-Piece

Lovejoy Two-Piece split shaft collars are designed to fully engage the shaft without marring or causing other shaft damage. Two piece collars are easily installed without the need for major disassembly, saving both man-hours and machine downtime.

Collars are made from the highest quality bar stock steel and black oxide finished for corrosion resistance and outstanding appearance. All Lovejoy shaft collars use socket cup point set screws for ease of installation and best possible holding strength. Contact customer service for price and availability.

Features

- Equally effective on both hard and soft shafts
- Made of 12L14 Mild Steel
- Hex Socket, Cup Point, 3A Thread Screws
- Made in the U.S.A.
- Tolerances:

Bore Diameter - +.003, -.000 in
 Outside Diameter - +.000, -.015 in
 Width - +.015 in

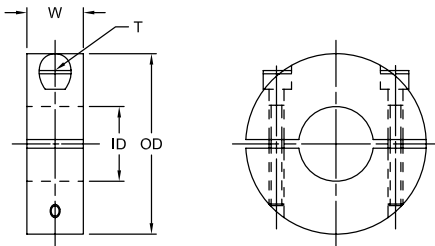

Two-Piece Split Shaft Collar

Shaft Collar - Two Piece Dimensional Data

Size	UPC Number	W in	T Clamp Screw	OD in	ID Bore in
SC2-2	63200	5/16	4-40 x 3/8	11/16	1/8
SC2-3	63201	5/16	4-40 x 3/8	11/16	3/16
SC2-4	63202	5/16	4-40 x 3/8	11/16	1/4
SC2-5	63203	5/16	4-40 x 3/8	11/16	5/16
SC2-6	63204	3/8	6-32 x 3/8	7/8	3/8
SC2-7	63205	3/8	6-32 x 3/8	15/16	7/16
SC2-8	63206	3/8	6-32 x 3/8	1-1/8	1/2
SC2-9	63207	13/32	8-32 x 1/2	1-5/16	9/16
SC2-10	63208	7/16	10-32 x 1/2	1-5/16	5/8
SC2-11	63209	1/2	10-32 x 1/2	1-1/2	11/16
SC2-12	63210	1/2	1/4-28 x 5/8	1-1/2	3/4
SC2-13	63211	1/2	1/4-28 x 5/8	1-5/8	13/16
SC2-14	63212	1/2	1/4-28 x 5/8	1-5/8	7/8
SC2-15	63213	1/2	1/4-28 x 5/8	1-3/4	15/16
SC2-16	63214	1/2	1/4-28 x 5/8	1-3/4	1
SC2-17	63215	1/2	1/4-28 x 5/8	1-7/8	1-1/16
SC2-18	63216	1/2	1/4-28 x 3/4	1-7/8	1-1/8
SC2-19	63217	1/2	1/4-28 x 3/4	2-1/16	1-3/16
SC2-20	63218	1/2	1/4-28 x 3/4	2-1/16	1-1/4
SC2-21	63219	9/16	1/4-28 x 3/4	2-1/4	1-5/16
SC2-22	63220	9/16	1/4-28 x 3/4	2-1/4	1-3/8
SC2-23	63221	9/16	1/4-28 x 3/4	2-1/4	1-7/16
SC2-24	63222	9/16	1/4-28 x 3/4	2-3/8	1-1/2
SC2-25	63223	9/16	1/4-28 x 3/4	2-3/8	1-9/16
SC2-26	63224	11/16	5/16-24 x 1	2-5/8	1-5/8
SC2-27	63225	11/16	5/16-24 x 1	2-3/4	1-11/16
SC2-28	63226	11/16	5/16-24 x 1	2-3/4	1-3/4
SC2-30	63227	11/16	5/16-24 x 1	2-7/8	1-7/8
SC2-31	63228	5/8	5/16-24 x 1	3	1-15/16
SC2-32	63229	11/16	5/16-24 x 1	3	2
SC2-34	63230	3/4	5/16-24 x 1	3-1/4	2-1/8
SC2-35	63231	3/4	5/16-24 x 1	3-1/4	2-3/16
SC2-36	63232	3/4	5/16-24 x 1	3-1/4	2-1/4
SC2-38	63233	3/4	5/16-24 x 1	3-1/2	2-3/8
SC2-39	63234	3/4	5/16-24 x 1	3-1/2	2-7/16
SC2-40	63235	7/8	3/8-24 x 1-1/4	3-3/4	2-1/2
SC2-42	63236	7/8	3/8-24 x 1-1/4	3-7/8	2-5/8
SC2-43	63237	7/8	3/8-24 x 1-1/4	4	2-11/16
SC2-44	63238	7/8	3/8-24 x 1-1/4	4	2-3/4
SC2-46	63239	7/8	3/8-24 x 1-1/4	4-1/4	2-7/8
SC2-47	63240	7/8	3/8-24 x 1-1/4	4-1/4	2-15/16
SC2-48	63241	7/8	3/8-24 x 1-1/4	4-1/4	3

Note: ■ When referencing the Lovejoy UPC number in this table, include 685144 as a prefix to the number shown.