

where the world turns for

**Lovejoy**<sup>®</sup>

Couplings

# Curved Jaw

CJ

## In This Section:

- CJ Series
- GS Series

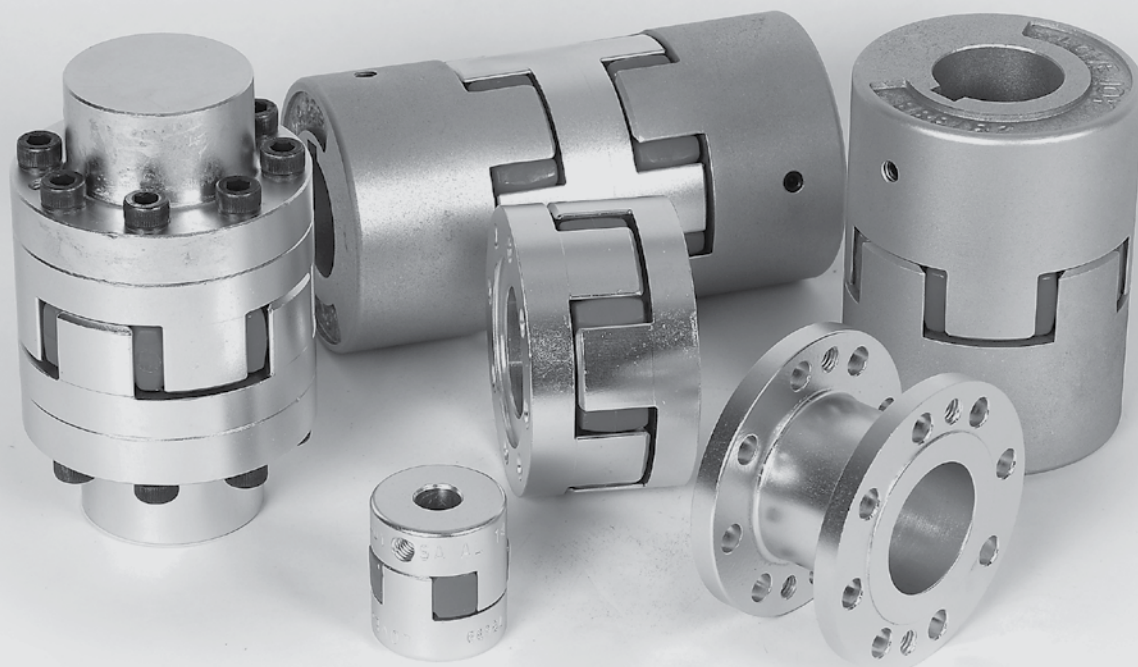

where the world turns for

**Lovejoy**

Couplings

CJ

# Curved Jaw

## Safety Warning

When using Lovejoy products, you must follow these instructions and take the following precautions. Failure to do so may cause the power transmission product to break and parts to be thrown with sufficient force to cause severe injury or death.

Refer to this Lovejoy Catalog for proper selection, sizing, horsepower, torque range, and speed range of power transmission products, including elastomeric elements for couplings. Follow the installation instructions included with the product, and in the individual product catalogs for proper installation of power transmission products. Do not exceed catalog ratings.

During start up and operation of power transmission product, avoid sudden shock loads. Coupling assembly should operate quietly and smoothly. If coupling assembly vibrates or makes beating sound, shut down immediately, and recheck alignment. Shortly after initial operation and periodically thereafter, where applicable, inspect coupling assembly for: alignment, wear of elastomeric element, bolt torques, and flexing elements for signs of fatigue. Do not operate coupling assembly if alignment is improper, or where applicable, if elastomeric element is damaged, or worn to less than 75% of its original thickness.

Do not use any of these power transmission products for elevators, man lifts, or other devices that carry people. If the power transmission product fails, the lift device could fall resulting in severe injury or death.

For all power transmission products, you must install suitable guards in accordance with OSHA and American Society of Mechanical Engineers Standards. Do not start power transmission product before suitable guards are in place. Failure to properly guard these products may result in severe injury or death from personnel contacting moving parts or from parts being thrown from assembly in the event the power transmission product fails.

If you have any questions, contact the Lovejoy Engineering Department at 1-630-852-0500.



# Curved Jaw



## Table of Contents

	Running Page No.	Section Page No.
CJ Series Design / Elastomers > Overview.....	52	CJ-4
CJ Series > Selection Process.....	53	CJ-5
CJ Series Elastomer Torque Rating > Performance Data.....	54	CJ-6
CJ Series Spiders > Dimensional Data.....	56	CJ-8
CJ Series Powder Metal / Steel > Dimensional Data.....	57	CJ-9
CJ Series Aluminum / Cast Iron / Nodular Iron > Dimensional Data.....	58	CJ-10
CJ Series Powder Metal / Cast Iron > Item Selection.....	59	CJ-11
CJ Series Aluminum > Item Selection.....	60	CJ-12
CJ Series > Displacement / Misalignment.....	61	CJ-13
CJ Series CJDB / CJSB > Dimensional Data.....	62	CJ-14
CJ Series CJLFH / CJDLF / CJSFH / CJDSF > Dimensional Data.....	63	CJ-15
CJ Series CJSPC / CJDSPC > Dimensional Data.....	64	CJ-16
Taper Lock > Dimensional Data.....	65	CJ-17
GS Series > Selection Process.....	66	CJ-18
GS Series > Overview / Performance / Dimensional Data.....	67	CJ-19
GS Series Performance / Torque Ratings > Performance Data.....	68	CJ-20
GS Series Hubs > Selection Data.....	69	CJ-21
GS Series Misalignment > Performance Data.....	70	CJ-22

## The Curved Jaw Design

- Three piece design that is easy to assemble
- The curved jaw design incorporates both radial and axial curvature (crowning) to the elastomer (spider)
- Hubs are offered in sintered iron, steel, aluminum, cast iron and nodular iron materials
- Three different urethane elastomers available
- No metal to metal contact and no lubrication required
- Fail safe design due to the jaw in compression design (continues to function after the elastomer fails)
- The CJ series covers a torque range of 67 to 247,800 in-lbs

## Elastomers

- Four types of spiders are available for the CJ Series of couplings
- Urethane spiders provide high abrasion resistance and elasticity, along with good damping characteristics
- The spiders are offered in a variety of shore hardnesses, each providing a different level of torque capacity, damping, and chemical resistance
- The 92A shore insert (yellow in color) is the standard, offering excellent torque carrying capacity
- The 80A shore insert (blue) offers the best damping characteristics
- The 95/98A shore spider (red) offers higher torque than the standard 92 shore, but retains greater damping capacity compared to the 64D shore insert (green)
- The 64D shore insert is offered for high humidity environments, higher temperatures, and offers the highest torque capacity
- The standard curved jaw spider design has a hole in the center to accommodate small between shaft end measurements
- The 80A, 92A, and 95/98A shore spiders have a temperature capacity of 212° F
- The 64D shore spider has a temperature capacity of 230° F
- The curved jaw spider's urethane material also resists oil, dirt, sand, grease, moisture, many solvents, as well as atmospheric effects of ozone

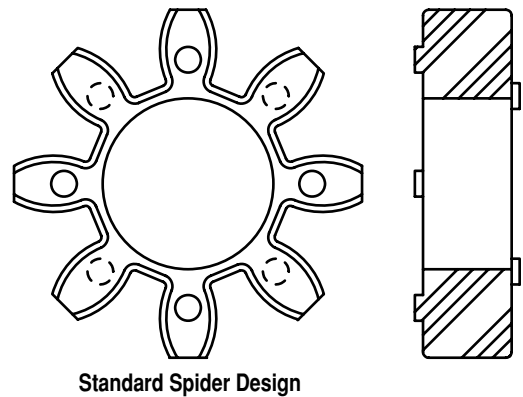

Standard Spider Design

## CJ Series Elastomer Recommendation Chart

Spider Type	Application types requiring:
80 shore A (Blue)	Good dampening properties
92 shore A (Yellow)	General & hydraulic applications
95/98 shore A (Red)	High torque requirements
64 shore (Green)	High humidity environments

## CJ Series Elastomer Performance Data

Spider Type	Color	Material	Temperature Range		Stock Sizes	Misalignment (inches)			Typical Applications
			Normal	Maximum		Angular	Parallel	Axial	
80 Shore A	Blue	Polyurethane	-40° to 212° F	-40° to 248° F	14-180	.9 - 1.3 deg	.008 - .027	.039 - 252	Good dampening properties
92 Shore A	Yellow	Polyurethane	-40° to 212° F	-50° to 248° F	14-180	.9 - 1.3 deg	.008 - .027	.039 - 252	General & hydraulic
95/98 Shore A	Red	Polyurethane	-40° to 212° F	-40° to 248° F	14-180	.9 - 1.3 deg	.008 - .027	.039 - 252	High torque requirements

## CJ Series Special Elastomer Data

Spider Type	Color	Material	Temperature Range		Stock Sizes	Misalignment (inches)			Typical Applications
			Normal	Maximum		Angular	Parallel	Axial	
64 Shore D	Green	Polyurethane	-30° to 230° F	-30° to 266° F	14-180	.9 - 1.3 deg	.008 - .027	.039 - 252	Highly humidity environments

## Steps In Selecting A Curved Jaw Coupling

**Step 1:** Determine the nominal torque of your application:

$$\text{in-lbs} = \text{Tkn} = \frac{\text{HP} \times 63025}{\text{RPM}}$$

**Step 2:** Calculate your Application Service Factor using the charts below. The total Service Factor (K) will be:

$$K = K1 \times K2 \times K3$$

**Step 3:** Calculate the design torque (DTkmax) of your application.

$$\text{Design Torque (DTkmax)} = \text{Nominal Torque} \times \text{service factor.}$$

**Step 4:** Using the Elastomer Torque Ratings Tables on pages CJ-6 and CJ-7 select the urethane shore hardness which best corresponds to your relative damping needs in the application.

**Step 5:** Next find the columns listing Tkn and Tkmax values listed in Nm and compare them against the DTkmax figure for your application. Make sure that the spider/coupling size values are larger than the application values.

**Step 6:** Once the size is selected using the torque values, check the table on page CJ-9 to make sure the bore size needed will fit in the coupling.

**Step 7:** Double check the overall dimensions of the coupling to ensure that it will fit in the space allowed for the coupling in the application.

\*This selection process is based on application factors only. A selection process is also available using DIN 740 part 2 standard. Consult with Lovejoy Engineering for details.

### Application Service Factor (K1)

Application Service Factor	Service Factor (K1)
Uniform operation with small masses to be accelerated. Hydraulic and centrifugal pumps, light generators, blowers, fans, ventilators, belt/screw conveyors.	1.0
Uniform operation with medium masses to be accelerated. Sheet metal bending machines, wood working machines, mills, textile machines, mixers.	1.2
Irregular operation, with medium masses to be accelerated. Rotating ovens, printing presses, generators, shredders, winders, spinning machines, pumps for viscous fluids.	1.3
Irregular operation and shocks, with medium masses to be accelerated concrete mixers, drop hammers, cable cars, paper mills, compression pumps, propeller pumps, rope winders, centrifuges.	1.4
Irregular operation and very heavy shocks, with large masses to be accelerated. Excavators, hammer mills, piston pumps, presses, rotary boring machines, shears, forge presses, stone crushers.	1.6
Irregular operation and very heavy shocks, with very large masses to be accelerated. Piston type compressors and pumps without speed variations, heavy roll sets, welding machines, brick presses, stone crushers.	1.8

Note: ■ If people are transported, Lovejoy does not recommend and will not warranty the use of the coupling.

### Application Service Factor for Starts per Hour (K2)

Starts Per Hour	100	200	400	800
Service Factor (K2)	1.0	1.2	1.4	1.6

### Application Service Factor for Ambient Temperature (K3)

Ambient Temperature	-30° to 30° C	40° C	6° C	80° C
Service Factor (K3)	1.0	1.2	1.4	1.6

### Definition of Terms

Tkn	Rated coupling torque
Tkmax	Maximum torque of the coupling
P[kW]	Power in kilowatts
RPM[1/min]	Revolutions per minute
Nm	Newton meters
DTkmax	Maximum torque of the application
Tkw	Varying load of an application in kilowatts
Pkw	Allowable power loss
BX Hub	Extended length hub



### WARNING

You must refer to page CJ-2 (Page 50) for Important Safety Instructions and Precautions for the selection and use of these products. Failure to follow the instructions and precautions can result in severe injury or death.



# Curved Jaw CJ Series Elastomer Torque Rating Performance Data

## CJ Series Elastomer Torque Ratings

Size	Maximum Speed RPM	Wind-Up Angle @		Torque		Torque		Rated HP @	
		Nominal Torque	Maximum Torque	Nominal in-lbs	Maximum in-lbs	Nominal Nm	Maximum Nm	1200 RPM	1800 RPM
<b>Urethane Spider - 92 Shore A (Yellow)</b>									
14	19,000	6, 4°	10°	66	133	7	15	1.2	1.9
19/24	14,000	3, 2°	5°	88	177	10	20	1.7	2.5
24/32	10,600			310	620	35	70	5.9	8.9
28/38	8,500			840	1,680	95	190	16.0	24.0
38/45	7,100			1,680	3,360	190	380	32.0	45.0
42/55	6,000			2,345	4,690	265	530	45.0	65.0
48/60	5,600			2,740	5,480	310	619	52.0	75.0
55/70	4,750			3,625	7,250	410	819	69.0	100.0
65/75	4,250			5,530	11,060	625	1 250	105.0	150.0
75/90	3,550			11,320	22,650	1 279	2 559	215.0	320.0
90/100	2,800			21,240	42,480	2 400	4 799	400.0	600.0
100/110	2,500			29,200	58,400	3 299	6 598	550.0	825.0
110/125	2,240			42,480	84,960	4 799	9 599	800.0	1,210.0
125/145	2,000			58,850	117,700	6 649	13 298	1,120.0	1,680.0
140	1,800			75,670	151,340	8 549	17 098	1,440.0	2,160.0
160	1,500			113,280	226,560	12 798	25 597	2,150.0	3,230.0
180	1,400			165,050	330,100	18 647	37 295	3,140.0	4,715.0
<b>Urethane Spider - 98/95 Shore A (Red)</b>									
14	19,000	6, 4°	10°	111	221	13	25	2.1	3.2
19/24	14,000	3, 2°	5°	150	300	17	34	2.5	4.0
24/32	10,600			530	1,000	60	113	10.0	15.0
28/38	8,500			1,415	2,830	160	320	25.0	40.0
38/45	7,100			2,875	5,750	325	650	55.0	80.0
42/55	6,000			3,980	7,960	450	899	75.0	110.0
48/60	5,600			4,645	9,290	525	1 050	85.0	125.0
55/70	4,750			6,060	12,120	685	1 369	115.0	170.0
65/75	4,250			8,320	16,640	940	1 880	150.0	225.0
75/90	3,550			16,990	33,980	1 920	3 869	320.0	480.0
90/100	2,800			31,860	63,720	3 600	7 199	600.0	900.0
100/110	2,500			43,805	87,610	4 949	9 898	800.0	1,250.0
110/125	2,240			63,720	127,440	7 199	14 398	1,280.0	1,820.0
125/145	2,000			88,500	177,000	9 999	19 997	1,685.0	2,525.0
140	1,800			113,280	226,560	12 798	25 597	2,150.0	3,235.0
160	1,500			169,920	339,840	19 198	38 395	3,235.0	4,850.0
180	1,400			247,800	495,600	27 996	55 993	4,720.0	7,080.0
<b>Urethane Spider - 80 Shore A Sizes 14 - 38 (Blue)</b>									
14	19,000	6, 4°	10°	35	71	4	8	1.0	2.0
19/24	14,000	3, 2°	5°	43	86	5	10	1.0	3.0
24/32	10,600			151	301	17	34	3.0	9.0
28/38	8,500			407	814	46	92	8.0	12.0
38/45	7,100			823	1,637	93	185	16.0	47.0



# Curved Jaw CJ Series Elastomer Torque Rating Performance Data

## CJ Series Elastomer Torque Ratings

Continued

Size	Maximum Speed RPM	Wind-Up Angle @		Torque		Torque		Rated HP @	
		Nominal Torque	Maximum Torque	Nominal in-lbs	Maximum in-lbs	Nominal Nm	Maximum Nm	1200 RPM	1800 RPM
<b>Urethane Spider 64 Shore D (Green)</b>									
19/24	14,000	2, 5°	3, 6°	185	370	21	42	3.5	5.0
24/32	10,600			660	1,320	75	149	12.5	18.0
28/38	8,500			1,770	3,540	200	400	30.0	50.0
38/45	7,100			3,585	7,170	405	810	65.0	100.0
42/55	6,000			4,955	9,910	560	1 120	90.0	140.0
48/60	5,600			5,795	11,590	655	1 309	110.0	165.0
55/70	4,750			7,300	14,600	825	1 650	125.0	200.0
65/75	4,250			10,395	20,790	1 174	2 349	190.0	290.0
75/90	3,550			21,240	42,480	2 400	4 799	400.0	600.0
90/100	2,800			39,825	79,650	4 499	8 999	750.0	1 125.0
100/110	2,500			54,735	109,470	6 184	12 368	1 040.0	1 550.0
110/125	2,240			79,650	159,300	8 999	17 998	1 515.0	2 275.0
125/145	2,000			110,630	221,260	12 499	24 998	2 100.0	3 160.0
140	1,800			141,600	283,200	15 998	31 996	2 690.0	4 045.0
160	1,500			212,400	424,800	23 997	47 994	4 045.0	6 060.0
180	1,400			309,750	619,500	34 996	69 991	5 900.0	8 850.0





## Curved Jaw Coupling Spiders Dimensional Data

Size	A		H		W	
	in	mm	in	mm	in	mm
14	1.18	30	0.39	10	0.39	10
19/24	1.57	40	0.71	18	0.47	12
24/32	2.16	55	1.06	27	0.55	14
28/38	2.56	65	1.15	29	0.59	15
38/45	3.15	80	1.50	38	0.71	18
42/55	3.74	95	1.81	46	0.79	20
48/60	4.13	105	2.01	51	0.83	21
55/70	4.72	120	2.36	60	0.87	22
65/75	5.31	135	2.68	68	1.02	26
75/90	6.30	160	3.15	80	1.18	30
90/100	7.87	200	3.94	100	1.34	34
100/110	8.86	225	4.45	113	1.50	38
110/125	10.04	255	5.00	127	1.65	42
125/145	11.42	290	5.79	147	1.81	46
140	12.60	320	6.50	165	1.97	50
160	14.57	370	7.48	190	2.24	57
180	16.54	420	8.66	220	2.52	64



CJ

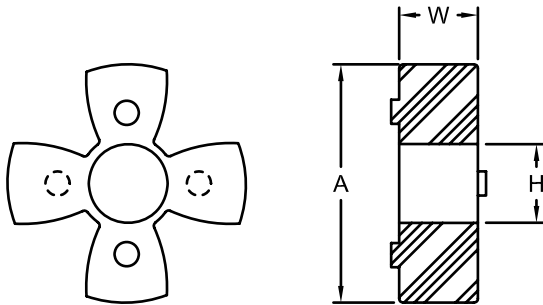

CJ 14

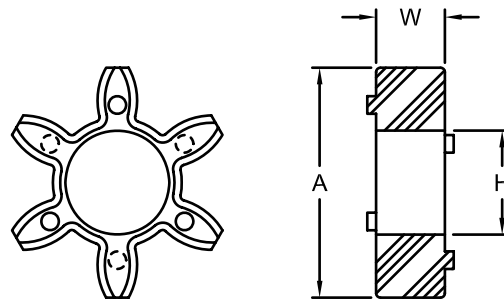

CJ 19/24

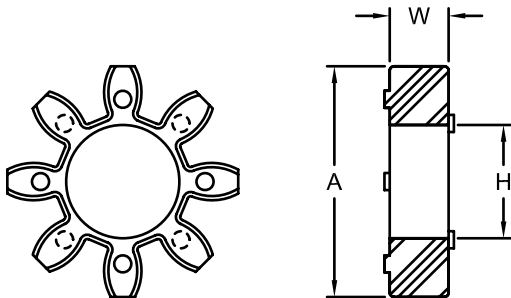

CJ 24/32 - 65/75

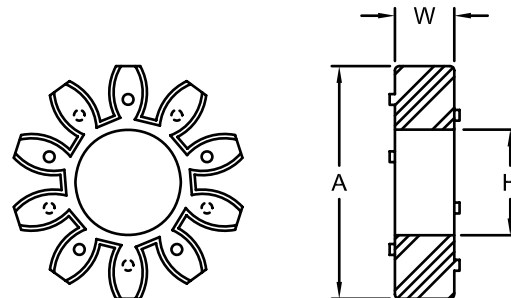

CJ 75/90 - 125/145



The Curved Jaw coupling consists of two standard hubs and one spider.

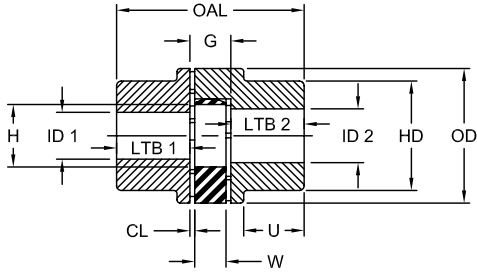

Configuration One - 2 A Hubs



Curved Jaw Coupling

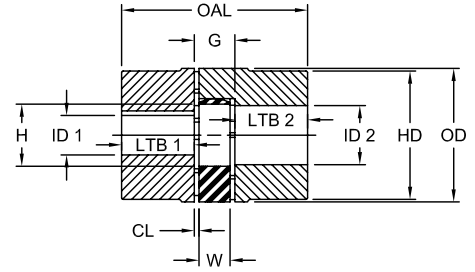

Configuration One - 2 B Hubs

### CJ Series Powder Metal / Steel Dimensional Data

Size	Hub Style	OAL in	G in	ID1 - ID2				LTB1 - LTB2 in	H in	CL in	U in	W in	OD in	HD in
				Min Bore		Max Bore*								
				in	mm	in	mm							
14	B Style	1.38	0.51	S	S	0.63	16	0.43	0.39	0.06	—	0.39	1.18	—
	BX Style	1.97	0.51	S	S	0.63	16	0.73	0.39	0.06	—	0.39	1.18	—
19/24	A Style	2.60	0.63	S	S	0.75	19	0.98	0.71	0.08	0.79	0.47	1.57	1.26
	B Style	2.60	0.63	0.71	18	0.94	24	0.98	0.71	0.08	—	0.47	1.57	—
	BX Style	3.54	0.63	S	S	0.94	24	1.46	0.71	0.08	—	0.47	1.57	—
24/32	A Style	3.07	0.70	0.47	12	0.95	24	1.18	1.06	0.08	0.94	0.55	2.20	1.57
	B Style	3.07	0.70	0.87	18	1.25	32	1.18	1.06	0.08	—	0.55	2.20	—
	BX Style	4.65	0.70	0.47	12	1.25	32	1.97	1.06	0.08	—	0.55	2.20	—
28/38	A Style	3.54	0.79	0.47	12	1.10	28	1.38	1.18	0.10	1.10	0.59	2.56	1.89
	B Style	3.54	0.79	0.87	22	1.50	38	1.38	1.18	0.10	—	0.59	2.56	—
	BX Style	5.51	0.79	0.47	12	1.50	38	2.36	1.18	0.10	—	0.59	2.56	—
38/45	A Style	4.49	0.94	0.47	12	1.50	38	1.77	1.50	0.12	1.46	0.71	3.15	2.60
	B Style	4.49	0.94	1.38	35	1.75	45	1.77	1.50	0.12	—	0.71	3.15	—
	BX Style	6.46	0.94	0.47	12	1.75	45	2.76	1.50	0.12	—	0.71	3.15	—
42/55	A Style	4.96	1.02	0.47	12	1.65	42	1.97	1.81	0.12	1.57	0.79	3.74	2.95
	B Style	4.96	1.02	1.02	26	2.13	55	1.97	1.81	0.12	—	0.79	3.74	—
	BX Style	6.93	1.02	0.47	12	2.13	55	2.95	1.81	0.12	—	0.79	3.74	—
48/60	A Style	5.51	1.10	0.47	12	1.88	48	2.20	2.01	0.14	1.77	0.83	4.13	3.35
	B Style	5.51	1.10	1.02	26	2.31	60	2.20	2.01	0.14	—	0.83	4.13	—
	BX Style	7.40	1.10	0.47	12	2.31	60	3.15	2.01	0.14	—	0.83	4.13	—
55/70	A Style	6.30	1.18	0.47	12	2.13	55	2.56	2.36	0.16	2.05	0.87	4.72	3.86
	B Style	6.30	1.18	1.89	48	2.75	70	2.56	2.36	0.16	—	0.87	4.72	—
	BX Style	8.27	1.18	0.47	12	2.75	70	3.54	2.36	0.16	—	0.87	4.72	—
65/75	A Style	7.28	1.38	0.47	12	2.50	65	2.95	2.68	0.18	1.85	1.02	5.31	4.53
	B Style	7.28	1.38	2.28	58	2.94	75	2.95	2.68	0.18	—	1.02	5.31	—
	BX Style	9.25	1.38	0.47	12	2.94	75	3.94	2.68	0.18	—	1.02	5.31	—
75/90	A Style	8.27	1.57	0.47	12	2.94	75	3.35	3.15	0.20	2.09	1.18	6.30	5.31
	B Style	8.27	1.57	1.97	50	3.50	90	3.35	3.15	0.20	—	1.18	6.30	—
	BX Style	10.24	1.57	1.97	50	3.50	90	4.33	3.15	0.20	—	1.18	6.30	—
90/100	A Style	9.65	1.77	0.47	12	3.50	90	3.94	3.94	0.22	2.44	1.34	7.87	6.30
	B Style	9.65	1.77	3.11	79	3.94	100	3.94	3.94	0.22	—	1.34	7.87	—
	BX Style	11.61	1.77	3.11	79	3.94	100	4.92	3.94	0.22	—	1.34	7.87	—
140	B Style	14.76	2.56	2.00	51	6.25	160	6.10	6.50	0.30	—	2.56	12.60	10.04
160	B Style	16.73	2.95	2.00	51	7.25	185	6.89	7.48	0.35	—	2.95	14.57	11.42
180	B Style	18.70	3.35	2.00	51	7.63	200	7.68	8.66	0.41	—	3.35	16.54	12.80

- Notes:
- \* indicates: Maximum bore may be achieved through the use of a shallow keyway.
  - CL = Distance between spider and hub face.
  - Max Bore refers to maximum straight bore with keyway allowed in hub.
  - S = Solid hub with no bore.
  - OD is equal to HD for B style aluminum sizes: 19, 24, and 28.

- W = Spider thickness.
- Outside diameter of spider equal to OD.
- H = Inside diameter of spider.

The Curved Jaw coupling consists of two standard hubs and one spider.

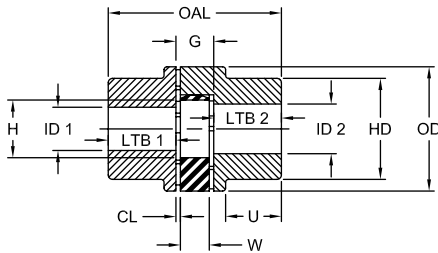

Configuration One - 2 A Hubs



Curved Jaw Coupling

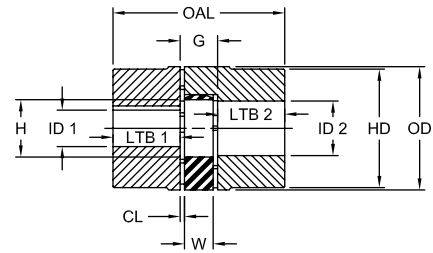

Configuration One - 2 B Hubs

### CJ Series Aluminum Dimensional Data

Size	Hub Style	OAL in	G in	ID1 - ID2				LTB1 - LTB2 in	H in	CL in	U in	W in	OD in	HD in
				Min Bore		Max Bore*								
				in	mm	in	mm							
14	B Style	1.38	0.51	S	S	0.63	16	0.43	0.39	0.06	—	0.39	1.18	—
	BX Style	1.97	0.51	S	S	0.63	16	0.73	0.39	0.06	—	0.39	1.18	—
19/24	A Style	2.60	0.63	S	S	0.75	19	0.98	0.71	0.08	0.79	0.47	1.57	1.26
	B Style	2.60	0.63	S	S	0.94	24	0.98	0.71	0.08	—	0.47	1.57	—
	BX Style	3.54	0.63	S	S	0.94	24	1.46	0.71	0.08	—	0.47	1.57	—
24/32	A Style	3.07	0.70	0.47	12	0.95	24	1.18	1.06	0.08	0.94	0.55	2.20	1.57
	B Style	3.07	0.70	0.87	18	1.25	32	1.18	1.06	0.08	—	0.55	2.20	—
	BX Style	4.65	0.70	0.47	12	1.25	32	1.97	1.06	0.08	—	0.55	2.20	—
28/38	A Style	3.54	0.79	0.47	12	1.10	28	1.38	1.18	0.10	1.10	0.59	2.56	1.89
	B Style	3.54	0.79	0.87	22	1.50	38	1.38	1.18	0.10	—	0.59	2.56	—
	BX Style	5.51	0.79	0.47	12	1.50	38	2.36	1.18	0.10	—	0.59	2.56	—
38/45	A Style	4.49	0.94	0.47	12	1.50	38	1.77	1.50	0.12	1.46	0.71	3.15	2.60
	B Style	4.49	0.94	1.38	35	1.75	45	1.77	1.50	0.12	—	0.71	3.15	—
	BX Style	6.46	0.94	0.47	12	1.75	45	2.76	1.50	0.12	—	0.71	3.15	—
42/55	A Style	4.96	1.02	0.47	12	1.65	42	1.97	1.81	0.12	1.57	0.79	3.74	2.95
	B Style	4.96	1.02	1.02	26	2.13	55	1.97	1.81	0.12	—	0.79	3.74	—
	BX Style	6.93	1.02	0.47	12	2.13	55	2.95	1.81	0.12	—	0.79	3.74	—
48/60	A Style	5.51	1.10	0.47	12	1.88	48	2.20	2.01	0.14	1.77	0.83	4.13	3.35
	B Style	5.51	1.10	1.02	26	2.31	60	2.20	2.01	0.14	—	0.83	4.13	—

### CJ Series Cast Iron / Nodular Iron Dimensional Data

Size	Hub Style	OAL in	G in	ID1 - ID2				LTB1 - LTB2 in	H in	CL in	U in	W in	OD in	HD in
				Min Bore		Max Bore*								
				in	mm	in	mm							
42/55	A Style	4.96	1.02	0.47	12	1.65	42	1.97	1.81	0.12	1.57	0.79	3.74	2.95
	B Style	4.96	1.02	1.02	26	2.13	55	1.97	1.81	0.12	—	0.79	3.74	—
48/60	A Style	5.51	1.10	0.47	12	1.89	48	2.20	2.01	0.14	1.77	0.83	4.13	3.35
	B Style	5.51	1.10	1.02	26	2.36	60	2.20	2.01	0.14	—	0.83	4.13	—
55/70	A Style	6.30	1.18	0.47	12	2.17	55	2.56	2.36	0.16	2.05	0.87	4.72	3.86
	B Style	6.30	1.18	1.89	48	2.76	70	2.56	2.36	0.16	—	0.87	4.72	—
65/75	A Style	7.28	1.38	0.47	12	2.56	65	2.95	2.68	0.18	1.85	1.02	5.31	4.53
	B Style	7.28	1.38	2.28	58	2.95	75	2.95	2.68	0.18	—	1.02	5.31	—
75/90	A Style	8.27	1.57	0.47	12	2.95	75	3.35	3.15	0.20	2.09	1.18	6.30	5.31
	B Style	8.27	1.57	1.97	50	3.54	90	3.35	3.15	0.20	—	1.18	6.30	—
90/100	A Style	9.65	1.77	0.47	12	3.54	90	3.94	3.94	0.22	2.44	1.34	7.87	6.30
	B Style	9.65	1.77	3.11	79	3.94	100	3.94	3.94	0.22	—	1.34	7.87	—
100	B Style	10.63	1.97	1.57	40	4.33	110	4.33	4.45	0.24	—	1.50	8.86	7.87
110	B Style	11.61	2.17	2.36	60	4.92	125	4.72	5.00	0.26	—	1.65	10.04	9.06
125	B Style	13.39	2.36	2.36	60	5.71	145	5.51	5.79	0.28	—	1.81	11.42	10.43

- Notes:
- \* indicates: Maximum bore may be achieved through the use of a shallow keyway.
  - CL = Distance between spider and hub face.
  - Max Bore refers to maximum straight bore with keyway allowed in hub.
  - S = Solid hub with no bore.
  - OD is equal to HD for B style aluminum sizes: 19, 24, and 28.

- W = Spider thickness.
- Outside diameter of spider equal to OD.
- H = Inside diameter of spider.



# Curved Jaw CJ Series Powder Metal / Cast Iron Item Selection

The Curved Jaw coupling consists of two standard hubs and one spider.

**CJ Series – Metric Powder Metal and Cast Iron UPC Number Selection Table**

Size	Keyway Size	Powder Metal (PM)					Cast Iron (CI)									
		14	19/24	24/32	28/38	38/45	42/55		48/60		55/70		65/75		75/90	
		B Hub	B Hub	B Hub	B Hub	B Hub	A Hub	B Hub	A Hub	B Hub	A Hub	B Hub	A Hub	B Hub	A Hub	B Hub
RSB*		61150	61154	60880	60881	60882	62414	62048	62415	62059	62416	62060	62417	62061	62418	62062
8mm	2 x 1	—	—	—	—	—	—	—	—	—	—	—	—	—	—	—
9mm	3 x 1.4	—	—	—	—	—	—	—	—	—	—	—	—	—	—	—
10mm	3 x 1.4	—	—	—	—	—	—	—	—	—	—	—	—	—	—	—
11mm	4 x 1.8	—	—	—	—	—	—	—	—	—	—	—	—	—	—	—
12mm	4 x 1.8	61151	—	—	70186	—	69805	—	—	—	—	—	—	—	—	—
14mm	5 x 2.3	61152	—	—	69376	—	—	—	—	—	—	—	—	—	—	—
15mm	5 x 2.3	—	—	—	71983	—	—	—	—	—	—	—	—	—	—	—
16mm	5 x 2.3	—	—	—	68549	—	—	—	—	—	—	—	—	—	—	—
18mm	6 x 2.8	—	—	—	71984	—	—	—	—	—	—	—	—	—	—	—
19mm	6 x 2.8	—	61156	—	61109	—	—	—	—	—	—	—	—	—	—	—
20mm	6 x 2.8	—	65080	—	61164	—	—	—	—	—	—	—	—	—	—	—
22mm	6 x 2.8	—	—	67509	66855	—	—	—	—	—	—	—	—	—	—	—
24mm	8 x 3.3	—	61157	61104	61110	—	—	—	—	—	—	—	—	—	—	—
25mm	8 x 3.3	—	—	61105	61165	—	66257	—	—	—	—	—	—	—	—	—
26mm	8 x 3.3	—	—	—	—	—	—	—	—	—	—	—	—	—	—	—
28mm	8 x 3.3	—	—	61106	61111	—	62049	—	—	—	—	—	—	—	—	—
30mm	8 x 3.3	—	—	68739	61112	—	62050	—	72031	—	—	—	—	—	—	—
32mm	10 x 3.3	—	—	—	65320	—	62051	—	66897	—	—	—	—	—	—	—
34mm	10 x 3.3	—	—	—	—	—	67238	—	—	—	—	—	—	—	—	—
35mm	10 x 3.3	—	—	—	67223	—	62052	—	72032	—	72040	—	69563	—	—	—
38mm	10 x 3.3	—	—	—	61113	—	62053	—	68037	—	71385	—	70240	—	—	—
40mm	12 x 3.3	—	—	—	—	69493	66824	70922	69280	—	70056	—	69293	—	—	—
42mm	12 x 3.3	—	—	—	—	60906	69800	62054	72033	—	72041	—	70376	—	—	—
45mm	14 x 3.8	—	—	—	—	66765	—	62055	69326	—	—	—	68074	—	—	—
48mm	14 x 3.8	—	—	—	—	—	—	62056	72034	71933	—	—	70344	—	—	—
50mm	14 x 3.8	—	—	—	—	—	—	62057	72035	66826	72043	—	69481	—	64121	—
55mm	16 x 4.3	—	—	—	—	—	—	62058	—	72036	72044	67513	71739	—	72051	—
60mm	18 x 4.4	—	—	—	—	—	—	—	—	69787	—	69219	68170	—	64744	—
65mm	18 x 4.4	—	—	—	—	—	—	—	—	—	—	66195	72050	67335	72052	—
70mm	20 x 4.9	—	—	—	—	—	—	—	—	—	—	72047	—	70231	65816	—
75mm	20 x 4.9	—	—	—	—	—	—	—	—	—	—	—	—	—	72058	—
80mm	22 x 5.4	—	—	—	—	—	—	—	—	—	—	—	—	—	—	68826
90mm	25 x 5.4	—	—	—	—	—	—	—	—	—	—	—	—	—	—	77760

Notes: ■ \* indicates: RSB maybe supplied as a solid hub or rough stock bore.  
 ■ When referencing a Lovejoy UPC number in this table, include 685144 as a prefix to the number shown.



# Curved Jaw CJ Series Aluminum / Steel BX Item Selection

The Curved Jaw coupling consists of two standard hubs and one spider.

**CJ Series – Metric Aluminum UPC Number Selection Table**

Size	Keyway Size	Aluminum													
		14		19/24		24/32		28/38		38/45		42/55		48/60	
		B Hub	A Hub	B Hub	A Hub	B Hub	A Hub	B Hub	A Hub	B Hub	A Hub	B Hub	A Hub	B Hub	
RSB*	No Keyway	71577	71441	71442	71443	71444	71445	71446	71447	71448	71449	71450	71451	71452	
6mm	2 x 1	71942	—	—	—	—	—	—	—	—	—	—	—	—	
8mm	2 x 1	71943	—	—	—	—	—	—	—	—	—	—	—	—	
9mm	3 x 1.4	71944	—	—	—	—	—	—	—	—	—	—	—	—	
10mm	3 x 1.4	71945	71951	—	—	—	—	—	—	—	—	—	—	—	
11mm	4 x 1.8	71946	71952	—	—	—	—	—	—	—	—	—	—	—	
12mm	4 x 1.8	71947	71953	—	—	—	—	—	—	—	—	—	—	—	
14mm	5 x 2.3	71948	71954	—	71961	—	71971	—	—	—	—	—	—	—	
15mm	5 x 2.3	71949	71950	—	71962	—	—	—	—	—	—	—	—	—	
16mm	5 x 2.3	—	71956	—	71963	—	71972	—	—	—	—	—	—	—	
18mm	6 x 2.8	—	—	—	71964	—	71973	—	—	—	—	—	—	—	
19mm	6 x 2.8	—	71957	—	91765	—	71974	—	—	—	—	—	—	—	
20mm	6 x 2.8	—	—	71958	71966	—	71975	—	71986	—	—	—	—	—	
24mm	8 x 3.3	—	—	—	71967	—	71976	—	71987	—	—	—	—	—	
25mm	8 x 3.3	—	—	71959	—	71968	71977	—	71988	—	—	—	—	—	
28mm	8 x 3.3	—	—	—	—	71969	71978	—	71989	—	—	—	—	—	
30mm	8 x 3.3	—	—	—	—	—	71979	—	71990	—	—	—	—	—	
32mm	10 x 3.3	—	—	—	—	—	—	71980	71991	—	72009	—	—	—	
35mm	10 x 3.3	—	—	—	—	—	—	—	71992	—	72010	—	72021	—	
38mm	10 x 3.3	—	—	—	—	—	—	71981	71993	—	72011	—	72022	—	
40mm	12 x 3.3	—	—	—	—	—	—	71982	—	71994	72012	—	72023	—	
42mm	12 x 3.3	—	—	—	—	—	—	—	—	71995	72013	—	72024	—	
45mm	14 x 3.8	—	—	—	—	—	—	—	—	—	—	72014	72025	—	
48mm	14 x 3.8	—	—	—	—	—	—	—	—	—	—	72015	—	—	
50mm	14 x 3.8	—	—	—	—	—	—	—	—	—	—	72016	72026	—	
55mm	16 x 4.3	—	—	—	—	—	—	—	—	—	—	72017	72027	72028	
60mm	18 x 4.4	—	—	—	—	—	—	—	—	—	—	72019	—	72029	
65mm	18 x 4.4	—	—	—	—	—	—	—	—	—	—	72020	—	72030	

Notes: ■ \* indicates: RSB maybe supplied as a solid hub or rough stock bore.  
 ■ When referencing a Lovejoy UPC number in this table, include 685144 as a prefix to the number shown.

**CJ Series – Metric Steel BX Style UPC Number Selection Table**

Size	Keyway Size	Steel BX Style							
		14	19/24	24/32	28/38	38/45	42/55	48/60	55/70
Solid	No Keyway	72062	72066	72067	72070	72073	72076	72080	72082
14mm	5 x 2.3	72063	—	—	—	—	—	—	—
19mm	6 x 2.8	—	72064	—	—	—	—	—	—
24mm	8 x 3.3	—	72065	72068	—	—	—	—	—
28mm	8 x 3.3	—	—	72069	—	—	—	—	—
30mm	8 x 3.3	—	—	—	72071	—	—	—	—
40mm	12 x 3.3	—	—	—	72072	72074	—	—	—
45mm	14 x 3.8	—	—	—	—	72075	—	—	—
55mm	16 x 4.3	—	—	—	—	—	72078	—	—

Note: ■ When referencing a Lovejoy UPC number in this table, include 685144 as a prefix to the number shown.

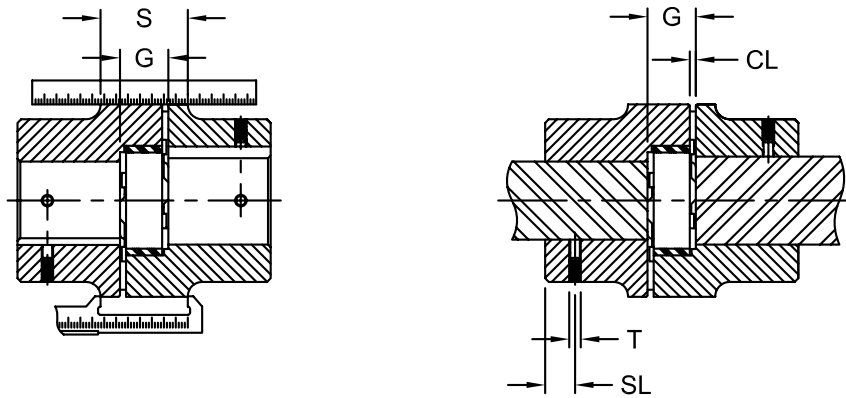

### CJ Series Installation and Misalignment Capabilities

Size:	14	19	24	28	38	42	48	55	65	75	90	100	110	125	140	160	180
<b>Dimensions</b>																	
<b>G</b>	0.51	0.63	0.70	0.79	0.94	1.02	1.10	1.18	1.38	1.57	1.77	1.97	2.17	2.36	2.56	2.95	3.35
<b>CL</b>	0.06	0.08	0.08	0.1	0.12	0.12	0.14	0.16	0.18	0.20	0.22	0.24	0.26	0.28	0.30	0.35	0.41
<b>H</b>	0.39	0.71	1.06	1.18	1.50	1.81	2.01	2.36	2.68	3.15	3.94	4.45	5.00	5.79	6.50	7.48	8.66
<b>S</b>	—	1.02	1.18	1.34	1.57	1.81	1.97	2.20	2.48	2.83	3.27	3.62	4.06	4.57	5.00	5.71	6.42

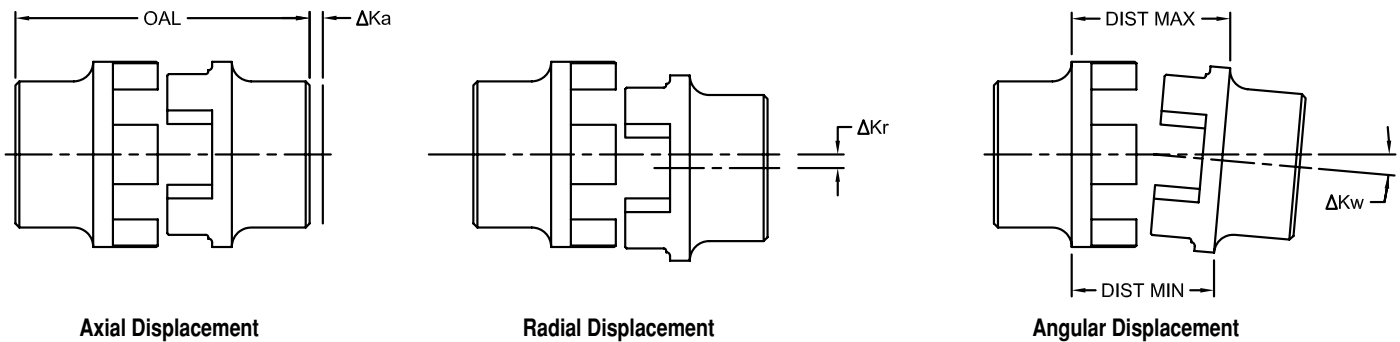

### CJ Series Displacement For Displacement / Misalignment (inches)

Size:	14	19	24	28	38	42	48	55	65	75	90	100	110	125	140	160	180
<b>Max Axial Displacement (Ka)</b>	0.04	0.047	0.055	0.06	0.07	0.079	0.082	0.87	0.102	0.12	0.133	0.15	0.165	0.18	0.19	0.22	0.25
<b>Max Radial Displacement (Kr)</b>	0.007	0.008	0.009	0.01	0.011	0.012	0.014	0.014	0.016	0.018	0.019	0.02	0.021	0.024	0.024	0.025	0.027
<b>Kw Max angular displacement n=1500 [1/min] in deg (Kw)</b>	1, 2	1, 2	0, 9	0, 9	1, 0	1, 0	1, 1	1, 1	1, 2	1, 2	1, 2	1, 2	1, 3	1, 3	1, 2	1, 2	1, 2
<b>Angular Displacement</b>	0.03	0.03	0.04	0.05	0.07	0.07	0.08	0.09	0.11	0.13	0.17	0.19	0.22	0.25	0.26	0.3	0.35
<b>Set Screw Information</b>																	
<b>Set Screw Size (T)</b>	8-32	10-24	10-24	5/16-18	5/16-18	5/16-18	5/16-18	3/8-16	3/8-16	3/8-16	3/8-16	1/2-13	5/8-11	5/8-11	—	—	—
<b>Set Screw Location (SL)</b>	0.2	0.39	0.39	0.59	0.59	0.79	0.79	0.79	0.79	0.98	1.18	1.18	1.38	1.57	1.77	1.97	1.97

The values regarding displacement are provided assuming normal operating conditions (i.e. temperature, torque with nominal rating of the coupling, speed/RPM rating of the coupling, and misalignment). Careful installation (i.e. alignment) and periodic inspection should be provided to provide the optimum life of the coupling. Special consideration should be given as to the position of the shafts and the amount of axial movement the coupling will be exposed to. The more accurate the alignment of the coupling, will result in greater life of the elastomer. A coupling guard and rotating equipment safety procedures should always be followed. Please consult the Lovejoy web site at [www.lovejoy-inc.com](http://www.lovejoy-inc.com) for assembly instructions of the curved jaw coupling.

The Curved Jaw Double Bolt (CJDB) coupling consists of two shaft hubs, two Jaw rings and one spider.

The Curved Jaw Single Bolt (CJSB) coupling consists of one shaft hub, one Jaw ring, one standard hub and one spider.

### Features

- Both curved jaw double bolt (CJDB) and single bolt (CJSB)
- Flange is available in steel only

CJ

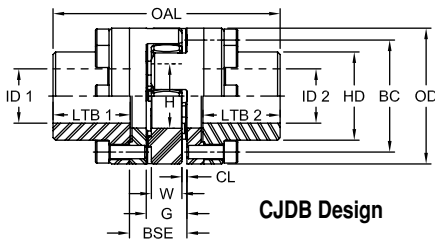

CJDB Design

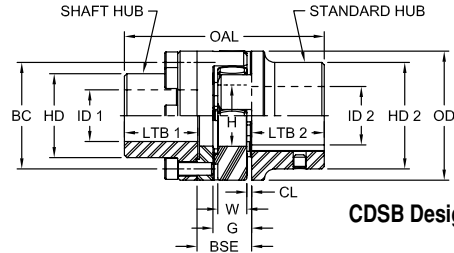

CJSB Design

### CJ Series CJDB and CJSB Dimensional Data

Size	OAL		LTB 1	LTB 2	ID1				ID2				CL	W	G
	CJDB	CJSB			Shaft Hub				Standard Hub						
					Min Bore	Max Bore	Min Bore	Max Bore							
in	in	in	in	in	mm	in	mm	in	mm	in	mm	in	in	in	
24	3.70	3.39	1.18	1.20	S	S	0.94	24	0.47	12	1.10	28	0.08	0.55	0.71
28	4.33	3.94	1.38	1.40	S	S	1.10	28	0.47	12	1.50	38	0.10	0.60	0.79
38	5.28	4.88	1.77	1.79	S	S	1.50	38	0.47	12	1.77	45	0.12	0.71	0.94
42	5.91	5.43	1.97	2.01	S	S	1.65	42	0.47	12	2.17	55	0.12	0.79	1.02
48	6.46	5.98	2.20	2.24	S	S	1.89	48	0.47	12	2.36	60	0.10	0.83	1.10
55	7.56	6.93	2.56	2.60	S	S	2.17	55	0.47	12	2.76	70	0.16	0.87	1.18
65	8.54	7.91	2.95	2.99	S	S	2.56	65	0.47	12	2.95	75	0.18	1.02	1.38
75	9.76	9.02	3.35	3.41	S	S	2.95	75	0.47	12	3.54	90	0.20	1.18	1.57
90	15.16	10.43	3.94	4.00	S	S	3.94	100	0.47	12	3.94	100	0.22	1.34	1.77
100	12.60	11.61	4.33	4.39	S	S	4.33	110	1.58	40	4.33	110	0.24	1.50	1.97
110	13.66	12.64	4.72	4.80	S	S	4.92	125	2.36	60	4.92	125	0.26	1.65	2.17
125	15.75	14.57	5.51	5.59	S	S	5.71	145	2.36	60	5.71	145	0.28	1.81	2.36
140	17.44	16.10	6.10	6.20	S	S	6.50	165	2.01	51	6.30	160	0.30	1.97	2.56
160	19.72	18.23	6.89	6.99	S	S	7.48	190	2.01	51	7.28	185	0.35	2.24	2.95
180	21.85	20.28	7.68	7.80	S	S	8.66	220	2.01	51	7.87	200	0.41	2.56	3.35

Note: ■ S = Solid hub with no bore.

### CJ Series CJDB and CJSB Dimensional Data

Continued

Size	BSE		OD	H	HD	HD2 (A Hub)	BC	Capscrew Size mm	# of Capscrews	Pitch	Capscrew Torque	
	CJDB	CJSB									in-lbs	Nm
24	1.30	1.02	2.17	1.06	1.42	1.57	1.77	M5 x 16	8	8 x 45°	89	10
28	1.54	1.18	2.56	1.18	1.65	1.89	2.13	M6 x 20	8		150	17
38	1.69	1.34	3.15	1.50	2.05	2.60	2.60	M8 x 22	8		363	41
42	1.89	1.50	3.74	1.81	2.44	2.95	3.15	M8 x 25	12	16 x 22.5°	363	41
48	1.97	1.57	4.13	2.01	2.76	3.35	3.54	M8 x 25	12		363	41
55	2.36	1.81	4.72	2.36	3.15	3.86	4.02	M10 x 30	8	8 x 45°	735	83
65	2.56	2.01	5.31	2.44	3.70	4.53	4.57	M12 x 40	12	16 x 22.5°	735	83
75	2.95	2.32	6.30	3.15	4.25	5.31	5.35	M16 x 40	15	20 x 18°	1,062	120
90	3.35	2.56	7.87	3.94	5.59	6.30	6.77	M16 x 50	15		2,611	295
100	3.82	2.95	8.86	4.45	6.22	—	7.68	M20 x 50	15		2,611	295
110	4.06	3.19	10.04	5.00	7.01	—	8.58	M20 x 60	15		5,133	580
125	4.57	3.54	11.42	5.79	8.11	—	9.92	M20 x 60	15		5,133	580
140	5.04	3.90	12.60	6.50	9.25	10.04	11.10	M20 x 60	15		5,133	580
160	5.75	4.45	14.57	7.48	10.63	11.42	12.80	M24 x 70	15		8,850	1 000
180	6.26	4.92	16.54	8.66	12.40	12.80	14.76	M24 x 80	18		24 x 15°	8,850

The Curved Jaw Large Flange to Hub (CJLFH) coupling consists of one standard hub, one large flange and one spider.  
 The Curved Jaw Double Large Flange (CJDLF) coupling consists of two large flanges and one spider.  
 The Curved Jaw Small Flange to Hub (CJSFH) coupling consists of one standard hub, one Jaw ring and one spider.  
 The Curved Jaw Double Small Flange (CJDSF) coupling consists of two Jaw rings and one spider.

### Features

- Flange to Flange design available for applications requiring space saving, compact connections
- Shaft to Flange design is also available for special application situations requiring an alternative connection

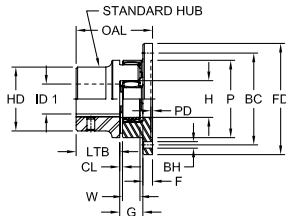

CJLFH Design

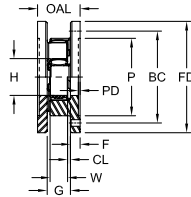

CJDLF Design

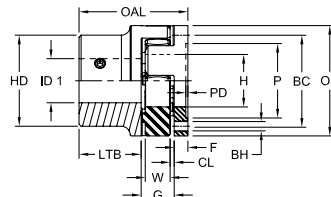

CJSFH Design

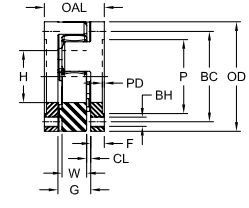

CJDSF Design

### CJ Series CJLFH, CJDLF, CJSFH and CJDSF Dimensional Data

Size	ID1				OD	H	LTB	G	CL	W	PD	F
	Standard Hub		General Dimensions									
	Min Bore in	Max Bore mm	in	mm								
24	0.472	12	1.102	28	2.17	1.06	1.18	0.71	0.08	0.55	0.06	0.31
28	0.472	12	1.496	38	2.56	1.18	1.38	0.79	0.01	0.59	0.06	0.39
38	0.472	12	1.772	45	3.15	1.50	1.77	0.94	0.12	0.71	0.06	0.39
42	0.472	12	2.165	55	3.74	1.81	1.97	1.02	0.12	0.79	0.08	0.47
48	0.472	12	2.362	60	4.13	2.01	2.20	1.10	0.14	0.83	0.08	0.47
55	0.472	12	2.756	70	4.72	2.36	2.56	1.18	0.16	0.87	0.08	0.63
65	0.472	12	2.953	75	5.31	2.68	2.95	1.38	0.18	1.02	0.08	0.63
75	0.472	12	3.543	90	6.30	3.15	3.35	1.57	0.20	1.18	0.10	0.75
90	0.472	12	3.937	100	7.87	3.94	3.94	1.77	0.22	1.34	0.12	0.79
100	1.575	40	4.331	110	8.86	4.45	4.33	1.97	0.24	1.50	0.16	0.98
110	2.362	60	4.921	125	10.04	5.00	4.72	2.17	0.26	1.65	0.16	1.02
125	2.362	60	5.709	145	11.42	5.79	5.51	2.36	0.28	1.81	0.20	1.18
140	2.008	51	6.299	160	12.60	6.50	6.10	2.56	0.30	1.97	0.20	1.34
160	2.008	51	7.283	185	14.57	7.48	6.89	2.95	0.35	2.24	0.20	1.50
180	2.008	51	7.874	200	16.54	8.66	7.68	3.35	0.41	2.52	0.22	1.57

### CJ Series CJLFH, CJDLF, CJSFH and CJDSF Dimensional Data

Continued

Size	FD	P	BC	CJLFH and CJDLF		CJSFH and CJDSF		OAL		OAL				
	CJLFH and CJDLF		CJSFH and CJDSF		CJSFH and CJDSF		OAL		OAL					
	in	in	in	# of Bolts	BH to DIN 69	CJLFH in	CJDLF in	in	in	in	# of Bolts	Pitch Z x a	CJSFH in	CJDSF in
24	3.15	2.17	2.56	5	0.22	2.20	1.34	1.42	1.77	M5	8	8 x 45°	2.20	1.34
28	3.94	2.56	3.15	6	0.26	2.56	1.57	1.73	2.13	M6	8	8 x 45°	2.56	1.57
38	4.53	3.15	3.74	6	0.35	3.11	1.73	2.13	2.60	M8	8	8 x 45°	3.11	1.73
42	5.51	3.74	4.53	6	0.35	3.46	1.97	2.56	3.15	M8	12	16 x 22.5°	3.46	1.97
48	5.91	4.13	4.92	8	0.35	3.78	2.05	2.95	3.54	M8	12	16 x 22.5°	3.78	2.05
55	6.89	4.72	5.71	8	0.43	4.37	2.44	3.31	4.02	M10	8	8 x 45°	4.37	2.44
65	7.48	5.31	6.30	10	0.43	4.96	2.64	3.78	4.57	M10	12	16 x 22.5°	4.96	2.64
75	8.46	6.30	7.28	10	0.53	5.67	3.07	4.41	5.35	M12	15	16 x 22.5°	5.67	3.07
90	10.24	7.87	8.86	12	0.69	6.50	3.35	5.71	6.77	M16	15	16 x 22.5°	6.50	3.35
100	11.22	8.86	9.84	12	0.69	7.28	3.94	6.50	7.68	M16	15	16 x 22.5°	7.28	3.94
110	12.99	10.04	11.42	12	0.87	7.91	4.21	7.09	8.58	M20	15	20 x 18°	7.91	4.21
125	14.57	11.42	12.80	16	0.87	9.06	4.72	8.46	9.92	M20	15	20 x 18°	9.06	4.72
140	16.14	12.60	14.17	16	0.87	10.00	5.24	9.65	11.10	M20	15	20 x 18°	10.00	5.24
160	18.11	14.57	16.14	16	1.02	11.34	5.94	11.02	12.80	M24	15	20 x 18°	11.34	5.94
180	20.47	16.54	18.31	16	1.02	12.60	6.50	12.99	14.76	M24	18	24 x 15°	12.60	6.50



The Curved Spacer (CJSPC) coupling consists of two standard hubs, one spacer and two spiders.

The Curved Drop-out Spacer (CJDSPC) coupling consists of two standard hubs, two Jaw rings, one spacer and two spiders.

### Features

- Hubs available in aluminum, sintered iron, cast iron, and steel
- Spacer style features an aluminum spacer piece
- Drop-out style features two inserts for increased damping and parallel misalignment capability
- Center drop-out design provides easy element replacement
- Designed to accommodate a larger shaft separation

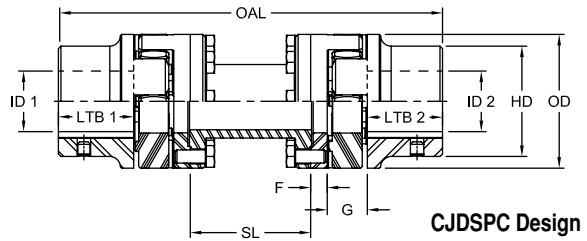
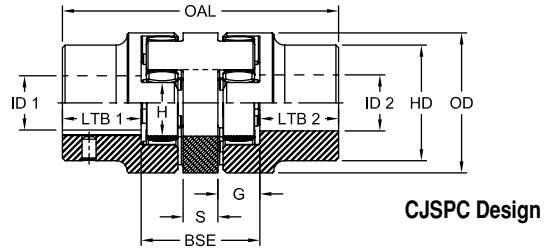

### CJ Series CJSPC and CJDSPC Dimensional Data

Size	OAL CJSPC in	OAL CJDSPC in	ID1 - ID2 Standard Hub				LTB1 - LTB2 in	H in	G in	S in	BSE in	OD in	HD (A Hub) in	F in	SL in
			Min Bore		Max Bore										
			in	mm	in	mm									
19	3.62	—	S	S	0.94	24	0.98	0.71	0.63	0.39	1.65	1.57	1.26	—	—
24	4.41	BSE+2.36	0.472	12	1.10	28	1.18	1.06	0.71	0.63	2.05	2.17	1.57	0.31	2.05
28	5.04	BSE+2.76	0.472	12	1.50	38	1.38	1.18	0.79	0.71	2.28	2.56	1.89	0.39	2.36
38	6.22	BSE+3.54	0.472	12	1.77	45	1.77	1.50	0.94	0.79	2.68	3.15	2.60	0.39	2.68
42	6.85	BSE+3.94	0.472	12	2.17	55	1.97	1.81	1.02	0.87	2.91	3.74	2.95	0.47	2.99
48	7.56	BSE+4.41	0.472	12	2.36	60	2.20	2.40	1.10	0.94	3.15	4.13	3.35	0.47	3.15
55	8.58	BSE+5.12	0.472	12	2.76	70	2.56	2.36	1.18	1.10	3.46	4.72	3.86	0.63	3.62
65	9.92	BSE+5.91	0.472	12	2.95	75	2.95	2.68	1.38	1.26	4.02	5.31	4.53	0.63	4.02
72	11.26	BSE+6.69	0.472	12	3.54	90	3.35	3.15	1.57	1.42	4.57	6.30	5.31	0.75	4.65
90	12.99	BSE+7.87	0.472	12	3.94	100	3.94	3.94	1.77	1.57	5.12	7.87	6.30	0.79	5.12

### CJ Series CJSPC and CJDSPC Dimensional Data

Continued

Size	Max radial displacement or max angular displacement I [°] with n = 1500 1/min	Tkn in-lbs	Tkmax in-lbs	Max radial displacement with 1° angular displacement and n = 1500 1/min				Max axial displacement	Hexagon screws DIN 933 8.8 or 10.9				
				Spacer for shaft distance dimension BSE					Bolt Size mm	# of Bolts	TA in-lbs	TA Nm	
				100	140	180	250						
19	0.03	—	—	—	—	—	—	—	—	—	—	—	—
24	0.04	310	620	0.06	—	—	—	0.06	M5	16	53	6	—
28	0.04	841	1,682	0.06	—	—	—	0.06	M6	16	124	14	—
38	0.05	1,682	3,363	0.05	0.08	—	—	0.07	M8	16	310	35	—
42	0.05	2,345	4,691	—	0.08	—	—	0.08	M8	16	310	35	—
48	0.05	2,744	5,487	—	0.08	—	—	0.08	M8	16	310	35	—
55	0.06	3,629	7,257	—	0.07	0.10	0.15	0.09	M10	8	611	69	—
65	0.07	5,531	11,063	—	—	—	0.15	0.10	M10	12	611	69	—
72	0.08	11,328	22,656	—	—	0.09	0.15	0.12	M12	15	1,062	120	—
90	0.01	21,240	42,480	—	—	—	0.14	0.13	M16	15	2,611	295	—

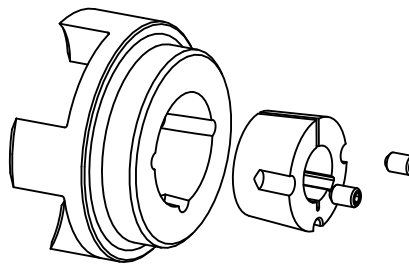
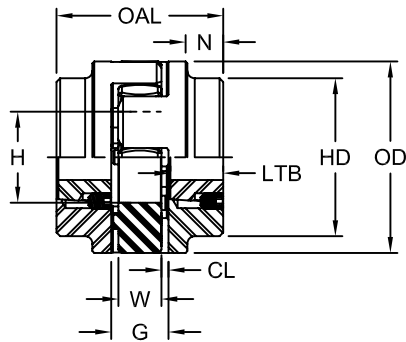

Reverse Mount

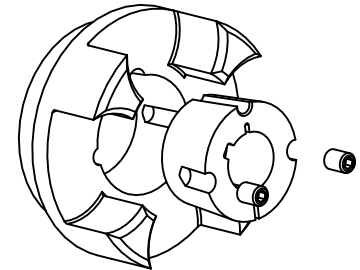

Front Mount



### Taper Loc Dimensional Data

Size	Taper Clamping Bushing	OAL in	N in	H in	LTB in	CL in	W in	G in	OD in	HD in	Fixing screw for taper bushing				
											Diameter in	Length in	# of Screws	Tightening Torque	
														in-lbs	Nm
28	1108	2.60	—	1.18	0.91	0.01	0.59	0.79	2.56	2.56	0.25	1/2	2	50	6
38	1108	2.76	0.59	1.50	0.91	0.12	0.71	0.94	3.15	3.07	0.25	1/2	2	50	6
42	1610	3.07	0.63	1.81	1.02	0.12	0.79	1.02	3.74	3.70	0.38	5/8	2	177	20
48	1615	4.17	1.10	2.01	1.54	0.14	0.83	1.10	0.59	4.09	0.38	5/8	2	177	20
55	2012	3.78	0.79	2.36	1.30	0.16	0.87	1.18	4.72	4.65	0.44	7/8	2	274	31
75	2517	5.67	1.42	3.15	2.05	0.20	1.18	1.57	6.30	5.31	0.50	1	2	434	49
	0.63										1-1/4	814		92	

### Taper Bushing Bore Reference Chart (Taper Loc Bushings Not Provided by Lovejoy)

Size of Taper Bushes	Available Bore Sizes															
	1/2	9/16	5/8	11/16	3/4	13/16	7/8	15/16	1	—	—	—	—	—	—	—
1108	1/2	9/16	5/8	11/16	3/4	13/16	7/8	15/16	1	—	—	—	—	—	—	—
1610	1/2	9/16	5/8	11/16	3/4	13/16	7/8	15/16	1	1-1/16	1-1/8	1-3/16	1-1/4	1-5/16	1-3/8	1-7/16
1615	1/2	9/16	5/8	11/16	3/4	13/16	7/8	15/16	1	1-1/16	1-1/8	1-3/16	1-1/4	1-5/16	1-3/8	1-7/16
2012	1/2	9/16	5/8	11/16	3/4	13/16	7/8	15/16	1	1-1/16	1-1/8	1-3/16	1-1/4	1-5/16	1-3/8	1-7/16
2517	1/2	5/8	11/16	3/4	13/16	7/8	15/16	1	1-1/16	1-1/8	1-3/16	1-1/4	1-5/16	1-3/8	1-7/16	1-1/2
3020	7/8	1-3/16	1	1-1/8	1-3/16	1-1/4	1-5/16	1-5/8	1-7/16	1-1/2	1-9/16	1-5/8	1-11/16	1-3/4	1-13/16	1-7/8

### Taper Bushing Bore Reference Chart (Taper Loc Bushings Not Provided by Lovejoy)

Continued

Size of Taper Bushes	Available Bore Sizes															
	—	—	—	—	—	—	—	—	—	—	—	—	—	—	—	—
1108	—	—	—	—	—	—	—	—	—	—	—	—	—	—	—	—
1610	1-1/2	—	—	—	—	—	—	—	—	—	—	—	—	—	—	—
1615	1-1/2	—	—	—	—	—	—	—	—	—	—	—	—	—	—	—
2012	1-1/2	1-9/16	1-5/8	1-11/16	1-3/4	1-13/16	1-7/8	—	—	—	—	—	—	—	—	—
2517	1-9/16	1-5/8	1-11/16	1-3/4	1-13/16	1-7/8	1-15/16	2	2-1/16	2-1/8	2-3/16	2-1/4	2-5/8	2-3/8	—	—
3020	1-15/16	2	2-1/16	2-1/8	2-3/16	2-1/4	2-15/16	2-3/8	2-7/16	2-1/2	2-5/8	2-11/16	2-3/4	2-13/16	2-7/8	—



## Typical Applications

### Measurement And Control Systems

The torsional stiffness of the GS Series coupling provides zero backlash needed for the accuracy for measurement and control systems. The low torques of these applications gives the GS Series the ability to provide zero backlash due to the elastomer pre-stress.

### Servo And Positioning Drives

The GS Series provides a zero backlash, flexible connection for servo and positioning drives. An added benefit of the GS Series is its damping capabilities. For applications that have vibrations at critical speeds, the GS Series coupling can provide a zero backlash solution for vibration problems.

### Main Spindle Drives

The GS Series coupling is used in main spindle drives for machine tools. Torque spikes and cyclical loading are handled by the GS Series by damping or by shifting the vibratory frequency range to a non-critical speed range.

CJ

## GS Series Service Factors

### Temperature Factor

	-30° to 30° C	40° C	60° C	80° C
K3	1	1,2	1,4	1,8

### Torsional Stiffness Factor

	Main Spindle Drive Of Machine	Positioning Drive	Shaft Encoders, Angle Encoders
K4	2-5	3-8	10

### Shock Load Factors

	K5
Light Shock Loads	1,0
Medium Shock Loads	1,4
Heavy Shock Loads	1,8

## Calculation Formula

$$\text{Rated nominal torque } T_{kn} [\text{in-lbs}] = \frac{\text{HP} \times 63025}{\text{RPM}}$$

$$\text{Rotational inertia coefficient (driver)} = \frac{\text{Moment of inertia (driver)}}{\text{Moment of inertia (driver)} + \text{Moment of inertia (driven)}}$$

$$\text{Rotational inertia coefficient (driven)} = \frac{\text{Moment of inertia (driven)}}{\text{Moment of inertia (driver)} + \text{Moment of inertia (driven)}}$$

Check the nominal torque for the application against the rating for the coupling:

$$T_{kn} > \text{Rated torque of machine} \times K3 \times K4$$

### Peak Torque

$$\text{Shock load (driver side)} = \text{Peak torque (driver)} \times \text{rotational inertia coefficient (driver)} \times K5$$

$$\text{Shock load (driven side)} = \text{Peak torque (driven)} \times \text{rotational inertia coefficient (driven)} \times K5$$

Check the peak torque for the application against the rating for the coupling (page CJ-20), checking both driver and driven sides:

$$T_{kmax} > \text{Peak Torque (driver or driven side)} \times K3 \times K4$$

The GS Series Curved Jaw coupling offers zero backlash capability in a 3-piece design. The coupling is provided assembled under prestress. The GS Series can be used in a variety of different applications requiring precision and accuracy.

The GS Series spider features a straight center of the spider tooth, providing higher stiffness due to coupling prestress. The crowning of the ends of the spider legs allows for misalignment, while the curved jaws and solid spider center provide high-speed capability.

The jaws of the hubs and the spider legs are chamfered to provide easy assembly. The GS Series coupling design also allows the blind assembly in tight spaces. Raised spider dots on the legs of the spider ensure proper spacing of hubs and spider.

Proper installation of the coupling can provide isolation of electrical currents. Check the CL dimension listed on this page to ensure the proper spacing between spiders and hubs.

The GS Series coupling has spiders available in four different shore hardnesses. Each spider offers benefits for different vibratory, environmental, and torque transmission requirements.

The GS Curved Jaw coupling consists of two hubs and one spider.



### Features

- Simple 3 piece jaw design
- Aluminum and steel material hubs
- Clamping and locking device hubs available
- Four different types of urethane shores to choose from

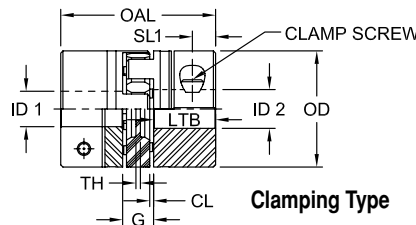

Clamping Type

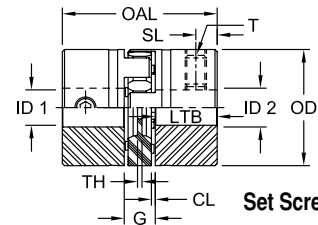

Set Screw Type

### GS Series Elastomer Performance Data

Spider Type	Color	Material	Temperature Range		Sizes Available	Typical Applications
			Normal	Maximum		
80 Shore A GS	Blue	Urethane	-50° to 176° F	-80° to 248° F	14-24	Electric measuring systems
92 Shore A GS	Yellow	Urethane	-40° to 194° F	-50° to 248° F	14-55	Electric measuring systems and control systems
95/98 Shore A GS	Red	Urethane	-30° to 194° F	-40° to 248° F	14-55	Positioning drives, main spindle drives, high load applications
64 Shore D GS	Green	Urethane	-20° to 230° F	-30° to 248° F	14-55	High load applications torsionally stiff spider material

### GS Series Dimensional Data

Size	Material	OAL in	G in	ID1 - ID2				LTB in	CL in	TH in	OD in	Set Screw Style		Clamping Bolt Style		
				Min Bore		Max Bore						Size in	Location in	Bolt Size mm	Bolt Location in	Torque in-lbs
				in	mm	in	mm									
14	Aluminum	1.38	0.51	S	S	0.625	16	0.433	0.06	0.08	1.18	8-32	0.20	M3	0.20	11.39
19/24	Aluminum	2.60	0.63	S	S	0.938	24	0.984	0.08	0.12	1.57	10-24	0.39	M6	0.47	92.93
24/32	Aluminum	3.07	0.71	S	S	1.250	32	1.180	0.08	0.12	2.17	10-24	0.39	M6	0.55	92.93
28/38	Aluminum	3.54	0.79	S	S	1.500	38	1.380	0.10	0.16	2.56	5/16-18	0.59	M8	0.59	221.25
38/45	Aluminum	4.49	0.94	S	S	1.750	44	1.770	0.12	0.16	3.15	5/16-18	0.59	M8	0.79	221.25
42/55	Steel	4.96	1.02	S	S	2.125	54	1.970	0.12	0.16	3.74	5/16-18	0.79	M8	0.79	221.25
48/60	Steel	5.51	1.10	S	S	2.312	59	2.200	0.14	0.16	4.13	5/16-18	0.79	M10	0.87	610.65
55/70	Steel	6.30	1.18	S	S	2.750	70	2.560	0.16	0.18	4.72	3/8-16	0.79	M12	0.98	1062.00
65/75	Steel	5.31	1.38	S	S	2.938	75	2.950	0.18	0.18	5.31	3/8-16	0.19	M16	1.26	2610.75

- Notes:
- S = Solid hub with no bore.
  - Specify Bore size ID1 and ID2 when ordering.
  - Specify keyway size if needed when ordering.



# Curved Jaw GS Series Performance / Torque Ratings Performance Data

## GS Series Performance Data

Size	Spider Durometer	Maximum Speed for Clamping Styles			Torque		Static Torsional Stiffness [lb in / rad]	Dynamic Torsional Stiffness [lb in / rad]	Radial Stiffness [b/in]	Complete Coupling Max Bore w/o Keyway	
		Clamping Hub	Set Screw Hub	Locking Device Hub	Tkn	Tkmax				Weight lbs	Polar Moment of Inertia J (lb-in <sup>2</sup> )(x10 <sup>-6</sup> )
		RPM	RPM	RPM	in-lbs	in-lbs					
14	80 Sh A	12,700	15,900	25,400	35.4	70.8	532.8	1,593	874	0.098	57
	92 Sh A				66.4	132.8	1,014.0	3,044	1,920		
	98 Sh A				110.6	221.3	1,521.0	4,540	3,452		
	64 Sh D				141.6	283.2	2,072.0	6,212	4,892		
19/24	80 Sh A	9,550	11,900	19,000	43.4	86.7	3,042.0	6,115	3,326	0.306	374
	92 Sh A				88.5	177.0	5,071.0	15,222	6,401		
	98 Sh A				150.5	300.9	7,606.0	22,833	11,487		
	64 Sh D				185.9	371.7	10,368.0	30,922	16,745		
24/32	92 Sh A	6,950	8,850	13,800	309.8	619.5	12,673.0	38,019	8,458	0.621	965
	98 Sh A				531.0	1,062.0	18,257.0	54,772	14,630		
	64 Sh D				663.8	1,327.0	26,355.0	79,065	21,123		
28/38	92 Sh A	5,850	7,350	11,700	840.8	1,681.0	20,284.0	60,852	10,173	1.178	3,691
	98 Sh A				1,416.0	2,832.0	30,426.0	91,278	18,288		
	64 Sh D				1,770.0	3,540.0	38,497.0	115,492	24,849		
38/45	92 Sh A	4,750	5,950	9,550	1,681.0	3,363.0	40,568.0	121,705	12,430	2.112	7,485
	98 Sh A				2,876.0	5,752.0	63,366.0	190,151	25,146		
	64 Sh D				3,584.0	7,168.0	93,279.0	279,837	36,999		
42/55	92 Sh A	4,000	5,000	8,050	2,345.0	4,690.0	55,755.0	128,236	13,887	8.324	40,639
	98 Sh A				3,982.0	7,965.0	169,920.0	424,800	31,833		
	64 Sh D				4,956.0	9,912.0	244,083.0	610,207	41,548		
48/60	92 Sh A	3,600	4,550	7,200	2,743.0	5,487.0	69,472.0	159,786	14,745	11.317	68,782
	98 Sh A				4,646.0	9,292.0	197,974.0	494,936	33,890		
	64 Sh D				5,798.0	11,593.0	320,370.0	800,925	47,286		
55/70	92 Sh A	3,150	3,950	6,350	3,628.0	7,257.0	84,075.0	193,372	17,031	16.993	135,334
	98 Sh A				6,062.0	12,124.0	210,630.0	52,675	38,210		
	64 Sh D				7,301.0	14,602.0	366,921.0	917,302	52,852		

## Torque Ratings for Clamp Style GS Series Hubs (C, CWK, DSC, and DSCK)

Size	5/16 in-lbs	3/8 in-lbs	7/16 in-lbs	1/2 in-lbs	9/16 in-lbs	5/8 in-lbs	11/16 in-lbs	3/4 in-lbs	7/8 in-lbs	15/16 in-lbs	1 in-lbs	1-3/32 in-lbs
19	221	239	239	257	266	274	283	283	310	—	—	—
24	—	301	310	319	336	345	345	345	363	381	398	407
28	—	—	—	708	717	717	743	752	770	805	814	859
38	—	—	—	—	814	832	859	867	876	920	929	965
42	—	—	—	—	—	—	—	—	2,053	2,159	2,177	2,257
48	—	—	—	—	—	—	—	—	—	—	3,478	3,584
55	—	—	—	—	—	—	—	—	—	—	—	—

## Torque Ratings for Clamp Style GS Series Hubs (C, CWK, DSC, and DSCK)

Continued

Size	1-3/16 in-lbs	1-1/4 in-lbs	1-3/8 in-lbs	1-1/2 in-lbs	1-9/16 in-lbs	1-5/8 in-lbs	1-3/4 in-lbs	1-7/8 in-lbs	1-15/16 in-lbs	2-1/8 in-lbs	2-5/16 in-lbs	2-1/2 in-lbs
19	—	—	—	—	—	—	—	—	—	—	—	—
24	—	—	—	—	—	—	—	—	—	—	—	—
28	876	903	929	965	—	—	—	—	—	—	—	—
38	991	1,000	1,044	1,080	1,089	1,115	1,151	—	—	—	—	—
42	2,301	2,354	2,425	2,505	2,549	2,602	2,664	2,735	—	—	—	—
48	3,655	3,726	3,841	3,938	4,018	4,089	4,186	4,301	4,372	4,549	—	—
55	—	4,186	4,301	4,407	4,487	4,549	4,655	4,770	4,841	5,018	5,195	5,381

## GS Series Hub Design (Descriptions)

The GS Series coupling features different hub designs for different application situations. Each type offers specific benefits for different types of applications. The clamping styles offer the benefit of minimal to zero backlash.

### Keyway With Set Screw (KW)

Standard Lovejoy method of securing a hub to a shaft. Clamping style recommended for backlash free torque transmission.

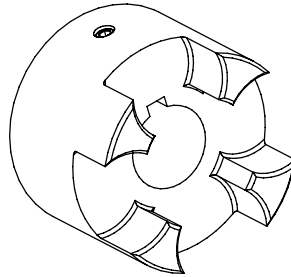

### Without Keyway, With Set Screw

Set screw used to secure hub to shaft. This hub design should be used in applications with non-reversing and low torque characteristics.

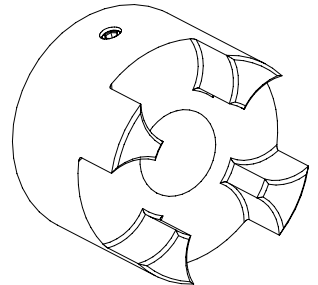

### Clamping Hub With Single Slot Without Keyway (C)

Zero backlash, clamping style for torque transmission. Torque capacity of hub depends on bore size. Available standard for sizes GS 14-19.

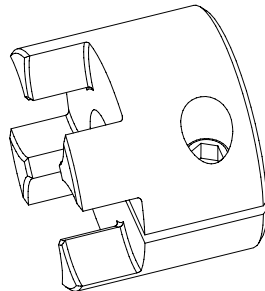

### Clamping Hub With Single Slot With Keyway (CWK)

Zero backlash, clamping style with keyway for torque transmission. Usable in applications featuring reversing loads. Available standard for sizes GS 14-19.

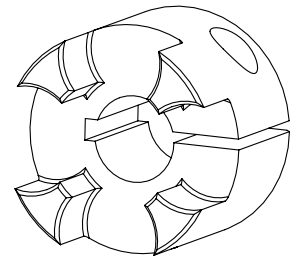

### Clamping Hub With Double Slot Without Keyway (DSC)

Transmits torque utilizing a double split clamp to attach hub to shaft. Zero or minimum backlash. Torque capacity of coupling determined by bore size. Available standard for sizes GS 24-55.

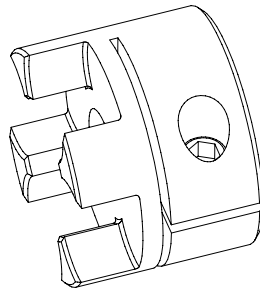

### Clamping Hub With Double Slot With Keyway (DSCK)

Transmits torque utilizing a double split clamp to attach hub to shaft. Zero or minimum backlash. Available standard for sizes GS 24-55.

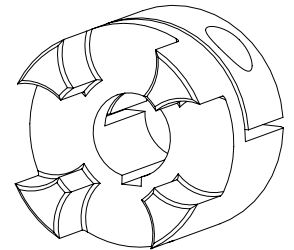

### Hub With Frictional Locking (LD)

This hub utilizes a shaft locking device to allow for shaft engagement. This design features bolts tightened on the jaw side of the hub. Available for sizes GS 14-55.

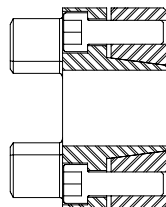

CJ

## GS Series Misalignment Information

The GS Series coupling handles the following types of misalignment: axial, angular, and radial. The coupling retains its zero backlash properties due to its spider design.

CJ

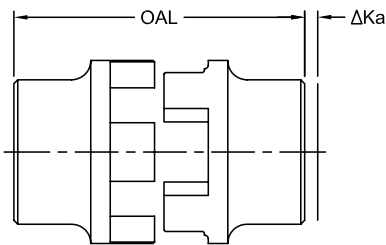

### Axial Misalignment

Axial misalignment can be caused by different shaft tolerances or by thermal expansion of shafts. The GS Series coupling handles axial misalignment while keeping reactionary forces low.

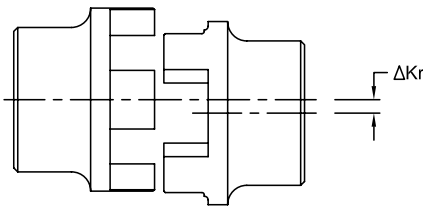

### Radial Misalignment

Radial misalignment can be defined as a measure of the offset distance between the centerlines of the driving and driven shafts. This type of misalignment, due to the forces involved, causes the highest stress.

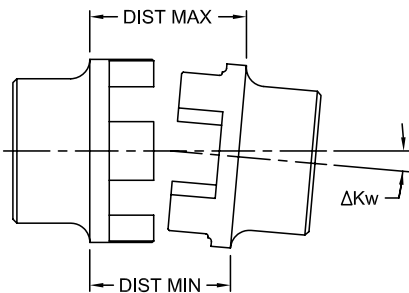

### Angular Misalignment

Angular misalignment can be defined as a measure of the angle between the centerlines of the driving and driven shafts, where those centerlines would intersect approximately halfway between shaft ends. The GS Series coupling can handle a specific amount of angular misalignment for each given size (refer to chart on right).

## GS Series Misalignment Data

Size	Spider Shore	Misalignment		
		Axial	Radial	Angular
14	80	+0.039 -0.019	0.008	1,1
	92		0.006	1,0
	98		0.003	0,9
	64		0.002	0,8
19	80	+0.047 -0.019	0.006	1,1
	92		0.004	1,0
	98		0.002	0,9
	64		0.001	0,8
24	92	+0.055 -0.019	0.005	1,0
	98		0.004	0,9
	64		0.003	0,8
28	92	+0.059 -0.027	0.006	1,0
	98		0.004	0,9
	64		0.003	0,8
38	92	+0.070 -0.027	0.007	1,0
	98		0.005	0,9
	64		0.003	0,8
42	92	+0.078 -0.039	0.007	1,0
	98		0.005	0,9
	64		0.004	0,8
48	92	+0.082 -0.039	0.009	1,0
	98		0.006	0,9
	64		0.004	0,8
55	92	+0.086 -0.039	0.009	1,0
	98		0.007	0,9
	64		0.005	0,8