

Magnescale

Digital Gauge General Catalog

SPEED X PRECISION



Magnescale

SPEED X PRECISION

Digital Gauge

Magnescale Co., Ltd.

Shinagawa Intercity Tower A-18F, 2-15-1, Konan, Minato-ku, Tokyo 108-6018, JAPAN

Headquarters : 45 Suzukawa, Isehara-shi, Kanagawa 259-1146, JAPAN

Tokyo Office : Shinagawa Intercity Tower A-18F, 2-15-1, Konan, Minato-ku, Tokyo 108-6018, JAPAN

Nagoya Office : 2-35-16, Meieki, Nakamura-ku, Nagoya Aichi, 450-0002, JAPAN

Osaka Office : 2-14-6, Nishi-Nakajima, Yodogawa-ku, Osaka 532-0011, JAPAN

International Sales Department : 45 Suzukawa, Isehara-shi, Kanagawa 259-1146, JAPAN

Magnescale Americas Inc. : 5740 Warland Drive, Cypress, CA 90630, USA

Magnescale Europe GmbH : Antoniusstrasse 14, 73249 Wernau, Germany

TEL.+81(0)463-92-1011 FAX.+81(0)463-92-1012

TEL.+81(0)3-5460-3574 FAX.+81(0)3-5460-9614

TEL.+81(0)52-587-1823 FAX.+81(0)52-587-1848

TEL.+81(0)6-6305-3101 FAX.+81(0)6-6304-6586

TEL.+81(0)463-92-7971 FAX.+81(0)463-92-7978

TEL.+1(562)594-5060 FAX.+1(562)594-5061

TEL.+49(0) 7153 934 291 FAX.+49(0) 7153 934 299

<http://www.mgscale.com>

The contents of this literature are as of Jul. 2011

This catalog is printed with soy ink.

MGS-DG-1107-EN-C

Magnescale Co., Ltd.

Safety

No compromise for high-accuracy products



The total quality control system that operates throughout the entire design and production process ensures products with enhanced safety, high quality, and high reliability that match our customers' requirements. The company is certified for length calibration in compliance with the traceability system required by the "Weights and Measures Act," and has been granted ISO 9001 certification, which is the international standard for quality assurance.



Isehara plant is registered to ISO 9001 (Quality)

Our products comply with CE Marking requirements, have acquired UL certifications and meet other regulations, ensuring safe use the world over.

We have met:

•EMC Directives(CE)

EMI: EN 55011 Group 1 Class A / 91

EMS: EN 61000-6-2

•FCC regulation

FCC Part 15 Subpart B Class A

for Products with built-in AC power supply:

•UL 61010-1

for Products with Laser:

•DHHS Class 1 (21CFR1040.10)

* When using our devices with machines to which the European Machinery Directive applies, please make sure that the devices when installed on the machines fulfill the applicable requirements of the Directive.
* Standards or regulations to be complied with may vary by product.

Traceability

Traceability Flow Chart (Length)

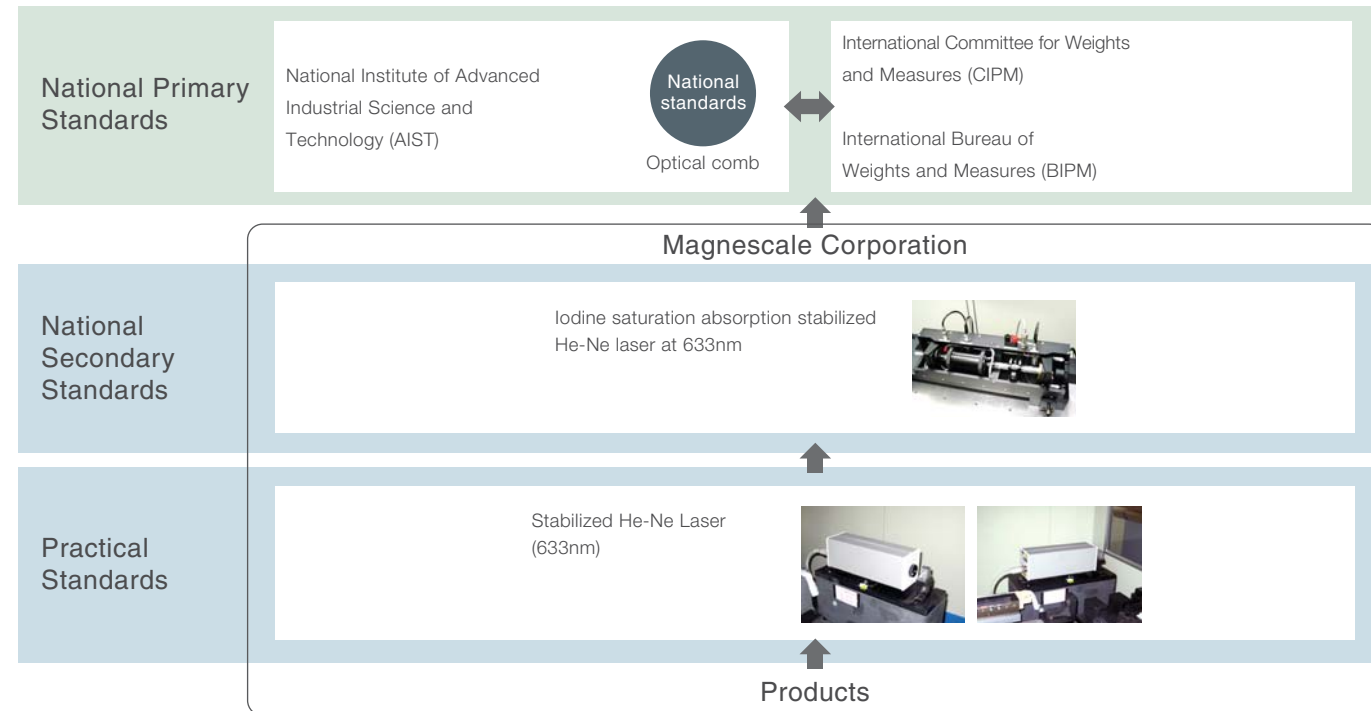

Magnescale Corporation

DIGITAL GAUGE

Contents

| | | | |
|-------------------------------|----|-----------------------|----|
| Safety | 2 | DT512 series | 30 |
| Traceability | 2 | DT12 / 32 series | 31 |
| Contents | 3 | MT12 / 13 / 14 | 33 |
| Applications | 4 | DL-B series | 34 |
| Lineup | 6 | U series | 36 |
| System | 8 | Interface unit | 39 |
| Gauge | 9 | MG40 series | 40 |
| DK802 A/Bseries | 10 | MG10/20/30 series | 42 |
| DK805 A/Bseries | 11 | Counter unit | 45 |
| DK812 A/Bseries | 12 | LT30 series | 46 |
| DK10/25 series | 13 | LT20A series | 47 |
| DK50/100 series | 14 | LT11A series | 48 |
| DK155/205 | 15 | LT10A series | 49 |
| DK110 | 16 | LY71 | 50 |
| DE-BR series | 20 | LY72 | 51 |
| DG805/DG810 series | 22 | Technical information | 52 |
| DG10/25 series | 23 | Accessories | 53 |
| DG50 / 100 / 155 / 205 series | 24 | Connection Cables | 54 |
| DG110 series | 26 | Compatible | 55 |

Applications

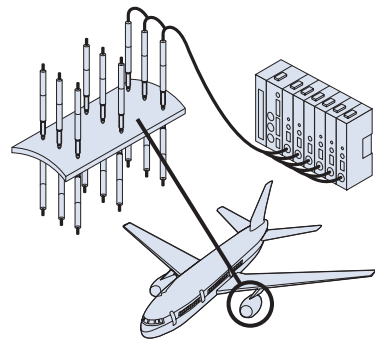

Multipoint measurement of turbine blades
Measures the blade shape of aircraft turbine blades.

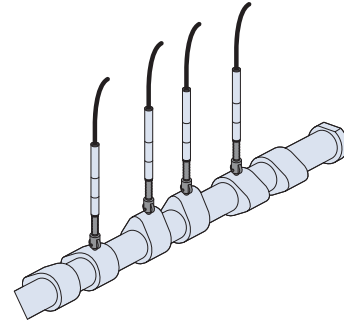

Camshaft displacement measurement
Measuring the height of camshaft lobes and journals.

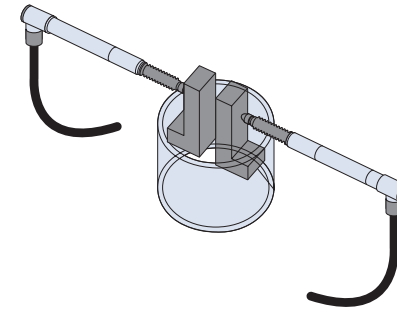

Measurement of inner diameter
Measuring the inner diameter of work.

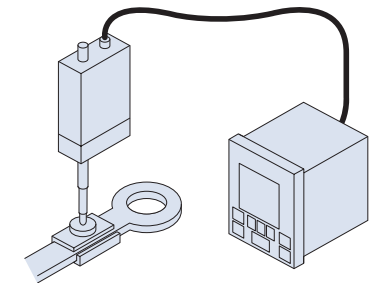

Measurement of crimp height
Measures the calking height of crimp terminal.

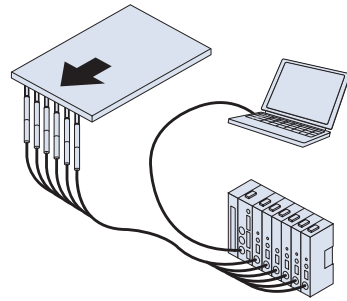

Multipoint measurement of liquid crystal panels
Measurement can be conducted easily in a small space by using a slim-shape measuring unit with fixture.

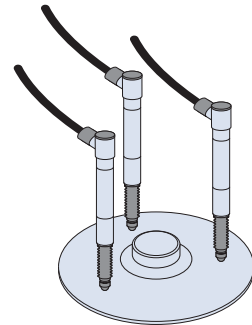

Measurement of hard disc flatness
Measuring the flatness of mass-produced discs.

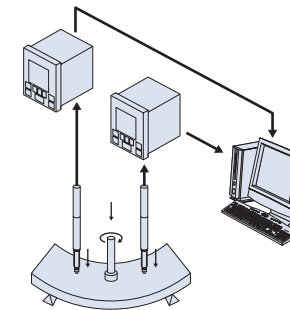

Measurement of material strength
Applicable for strength tests of various materials such as metal, resin materials and wood. Measuring unit is resistant to vibration.

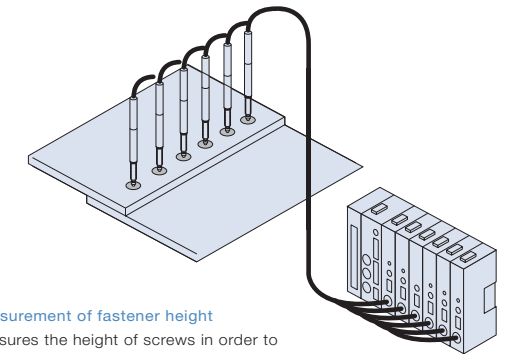

Measurement of fastener height
Measures the height of screws in order to control the amount of torque.

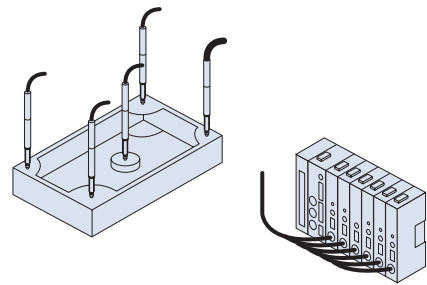

Measurement of the height of chassis height
Measurement can be conducted easily in a small space by using a slim-shape measuring unit. Measuring multiple points or a chassis.

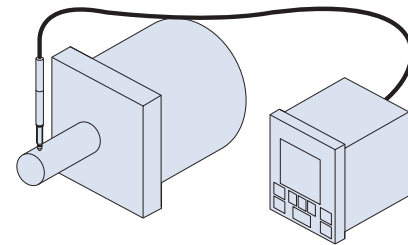

Measurement of motor shaft deviation
Measurement of a high speed spinning object is possible by utilizing a vibration-resistant gauge.

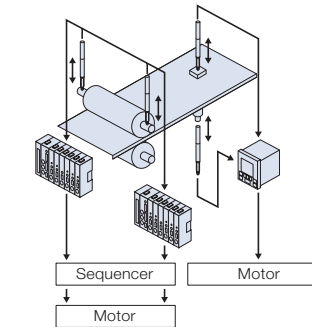

Positioning control
Measuring the thickness and flatness of objects moving at high-speed, such as metal plates, resin boards and film, as well as to control the position of feeding rollers.

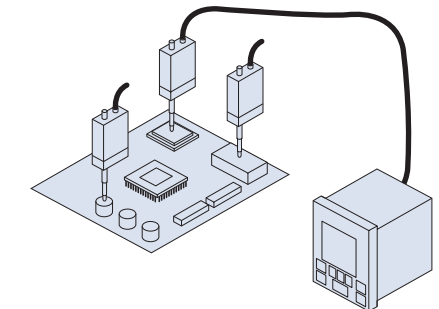

Measurement of the height of high-density mounting wiring boards
High-density measurement is possible with a slim-shaped measuring unit.

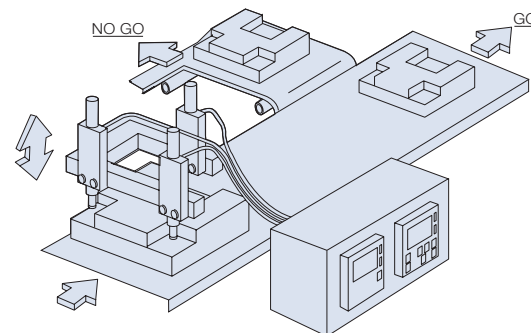

Automatic measurement and screening
Measurement/QA decisions can be performed on the production line.

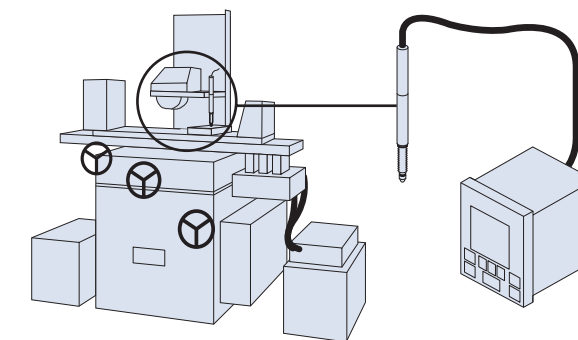

Combination with machine tools
Measuring the position of the grinding stone of surface grinding machines.

Lineup

| Resolution (μm) | 0.1 | | 0.5 | | 1 | 5 | 10 | |
|---------------------------------|--|--|--|--|---|--|---|-----------------------------------|
| | DK | DE | DK | DG | DT | DT | DL | |
| Digital Gauge | 2 | DK802AR, DK802BR (Straight) DK802ALR, DK802BLR (Right angle) | | DK802AR5, DK802BR5 (Straight) DK802ALR5, DK802BLR5 (Right angle) | | | | |
| | 5.2 | DK805AR, DK805BR (Straight) DK805ALR, DK805BLR (Right angle) DK805AFR, DK805BFR (Straight • Flange) DK805AFLR, DK805BFLR (Right angle • Flange) | | DK805AR5, DK805BR5 (Straight) DK805ALR5, DK805BLR5 (Right angle) DK805AFR5, DK805BFR5 (Straight • Flange) DK805AFLR5, DK805BFLR5 (Right angle • Flange) | DG805BL (Right angle • Low measuring force) DG805FL (Right angle • Flange • Low measuring force) | | | |
| | 10 | | DK10PR5 (Straight • Protect sealing) DK10NR5 (Straight) DK10PLR5 (Right angle • Protect sealing) | DG810B (Straight) DG810BL (Right angle) DG810F (Straight • Flange) DG810FL (Right angle • Flange) DG10B (Straight) | | | DL310B (Straight • Protect sealing) | |
| | 12 | DK812AR, DK812BR (Straight) DK812ALR, DK812BLR (Right angle) | DE12BR (Straight) | DK812AR5, DK812BR5 (Straight) DK812ALR5, DK812BLR5 (Right angle) | | DT512N (BOX type) DT512P (BOX type • Protect sealing) | DT12N (Straight) DT12P (Straight • Protect sealing) | |
| | 25 | | DK25PR5 (Straight • Protect sealing) DK25NR5 (Straight) DK25PLR5 (Right angle • Protect sealing) DK25NLR5 (Right angle) | DG25BN (Straight) DG25BP (Straight • Protect sealing) DG25BL (Right angle) DG25BS (Right angle) DG25B (Straight • Protect sealing) | | | | |
| | 30 32 | | DE30BR (Straight) | | | | DT32N (Box type) DT32NV (Box type • Pneumatic push) DT32P (Box type • Protect sealing) DT32PV (Box type • Protect sealing • Pneumatic push) | DL330B (Straight) |
| | 50 60 | | | DK50PR5 (Straight • Protect sealing) DK50NR5 (Straight) | DG50BN (Straight) DG25BP (Straight • Protect sealing) | | | |
| | 100 110 | | | DK100PR5 (Straight • Protect sealing) DK100NR5 (Straight) DK110NLR5 (Right angle • Protect sealing) | DG100B (Straight) DG110B (Right angle) | | | |
| | 155 | | | DK155PR5 (Straight • Protect sealing) | DG155B (Straight) | | | |
| | 205 | | | DK205PR5 (Straight • Protect sealing) | DG205B (Straight) | | | |
| Counter | DIN size | LT30 | LT30 + SZ70-2 (Adapter) | LT30 | LT20A | LT11A | LT10A | LT20A |
| | Full type | •LY71 •LY72 (Connection cable CE29) | •LY71, LY72 (+SZ70-1 (Adapter)) | •LY71 •LY72 (Connection cable CE29) | •LY71, LY72 (+DZ51 +SZ70-1) | •LY71, LY72 (+MT13 +CE29) | •LY71, LY72 (+MT13 +CE29) | •LY71 •LY72 (+DZ51 +SZ70-1) |
| Interface | MG40 series MG30 MG20-DK MG10 | MG30 MG20-DK MG10 (+ SZ70-2 (Adapter)) | MG40 series MG30 MG20-DK MG10 | MG30 MG20-DG MG10 | MG30 MG20-DT MG10 | MG30 MG20-DT MG10 | MG30 MG20-DG MG10 | |

System

Interface unit

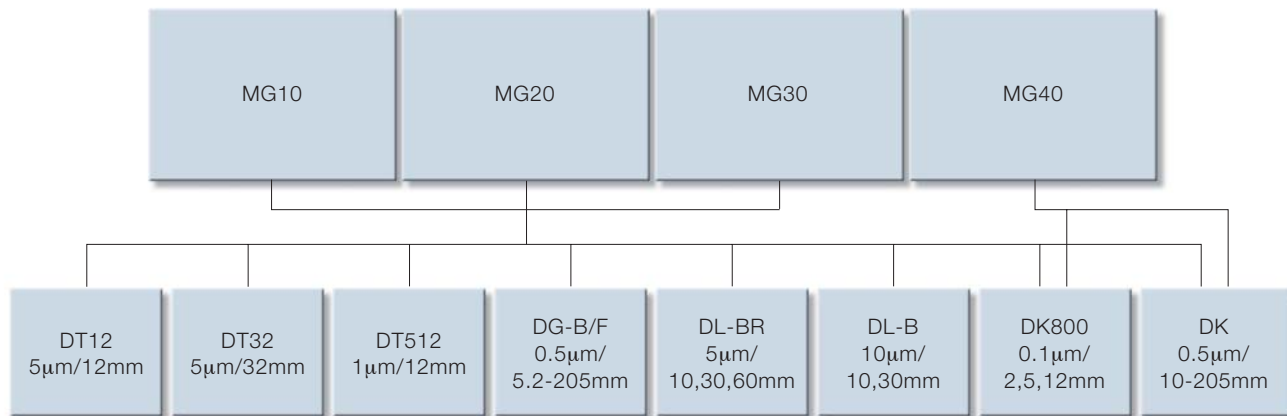

Counter

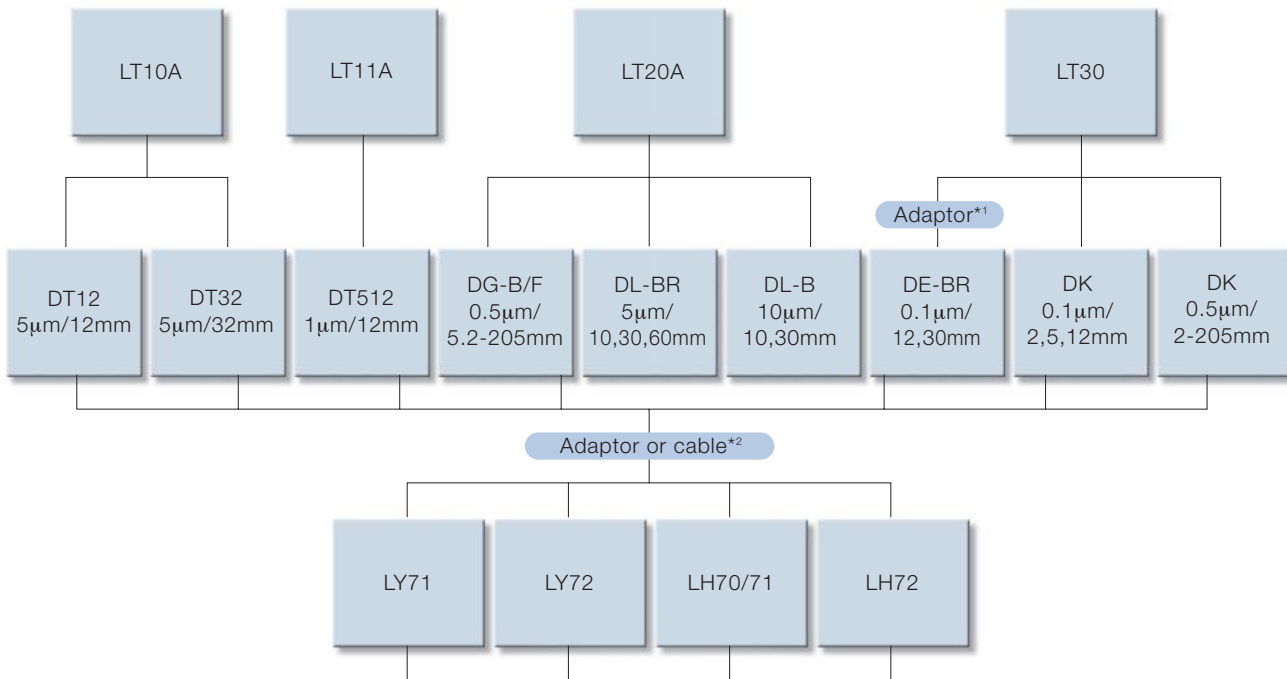

*1: Please see P6-7 "Lineup" about the type name.

*2: Please see P6-7 "Lineup" about the type name.

View in table

| Type |
|---|
| Maximum resolution/ effective length |

*The standard, the specification, and externals might change without a previous notice for the improvement.

*Please see the end of a book of this catalog for details of the connecting cable.

Gauge

| | |
|-----------------------------------|----|
| DK802A/B Series | 10 |
| DK805A/B Series | 11 |
| DK812A/B Series | 12 |
| DK10/25 Series | 13 |
| DK50/100 Series | 14 |
| DK155/205 Series | 15 |
| DK110 Series | 16 |
| DE-BR Series | 20 |
| DG805/DG810 Series | 22 |
| DG10B/DG25B Series | 23 |
| DG50, DG100, DG155, DG205B Series | 24 |
| DG110B | 26 |
| DT512N/P Series | 30 |
| DT12, 32 Series | 31 |
| MT12/13/14 | 33 |
| DL-B Series | 34 |
| U Series | 36 |

DK

DK802A/B Series

High resolution and High accuracy compact digital gauges.

- Measuring range: 2 mm ● Accuracy: 1 μm, 1.5 μm ● Resolution: 0.1 μm, 0.5 μm
- Max. response speed: 80m/min (Resolution: 0.1 μm)
250m/min (Resolution: 0.5 μm)
- Built-in reference point ● Excellent resistance to workshop conditions.
- Robust design for harsh environments.

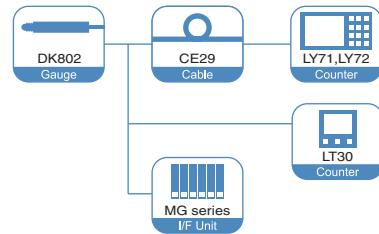

DK802AR/DK802AR5/
DK802BR/DK802BR5

Digital Gauge

Dimensions

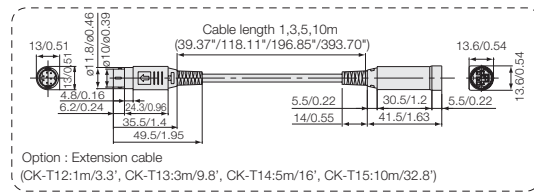
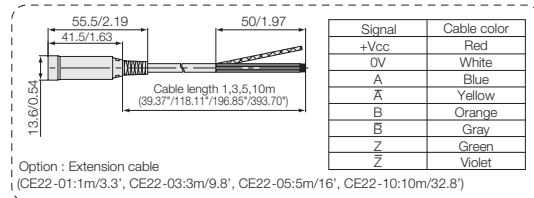

DK802AR/DK802AR5/
DK802BR/DK802BR5

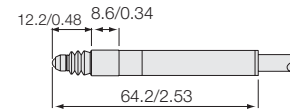

DK802ALR/DK802ALR5/
DK802BLR/DK802BLR5

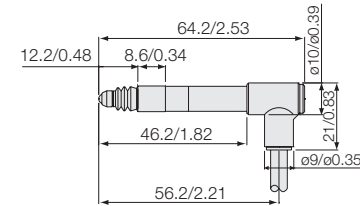

Unit : mm/inch

Specifications DK802 Series

| Model | High-resolution Flange models | | General-purpose resolution Flange models | |
|---|---|-------------------|---|---------------------|
| | DK802AR, DK802ALR | DK802BR, DK802BLR | DK802AR5, DK802ALR5 | DK802BR5, DK802BLR5 |
| Output | A/B/Z phase voltage-differential line driver output (compliant with EIA-422) | | | |
| Signal pitch | 40 μm | | | |
| Resolution | 0.1 μm | | 0.5 μm | |
| Measuring range | 2 mm (0.08") | | 5 mm | |
| *Accuracy (at 20°C / 68°F)* | 1 μm | | 1.5 μm | |
| Measuring force (at 20°C / 68°F) | Downward: 0.45 ± 0.25 N Horizontal: 0.40 ± 0.25 N Upward: 0.35 ± 0.25 N | | | |
| Reference point | One location (at 1 mm/0.04" position of spindle movement) | | | |
| Maximum response speed | 80 m/min | 42 m/min | 250 m/min | 100 m/min |
| Air driving | Vacuum suction (DK802ALR / DK802ALR5 / DK802BLR / DK802BLR5) | | | |
| Vibration resistance (10 to 2000 Hz) | 100m/s ² | | | |
| Impact resistance (11 ms) | 1000m/s ² | | | |
| Protective structure | IP66 (not including interpolation box and connectors) | | | |
| Operating temperature | 0°C to 50°C/32°F to 122°F | | | |
| Storage temperature | -20°C to 60°C/-4°F to 140°F | | | |
| Power supply voltage | DC +5 V ±5% | | | |
| Power consumption | 1 W | | | |
| Cable length | 2.5 m/8.2' | | | |
| Diameter of stem | φ8 / 0.31" dia. | | | |
| Mass ¹ | Approx. 20 g/0.7 oz | | | |
| Feeler | Provided with a carbide ball tip (DZ-123) Mount screw M2.5 | | Provided with a steel ball tip Mount screw M2.5 | |
| Accessories | +P M4x5 screw (2pcs.), Installation spacer, Instruction Manual, Supplement | | | |
| *Output cable length(up to the electronic section)* | 22 m/72.2' max. | | | |

*1: The mass indicated is the total mass excluding the cable and interpolation box.

DK

DK805A/B Series

High accuracy, compact, and slim gauges suitable for installation on machines.

- Magnetic principle ● Excellent resistance to workshop conditions.
Resistant to oil, water, dust, vibration, and shock. ● Accuracy : 1 μm, 1.5 μm
- Resolution : 0.1 μm, 0.5 μm ● Measuring range: 5 mm
- Low measuring force
- Spindle can be moved vertically with an air pressure device
- Easy installation. Flange type gauges also available.

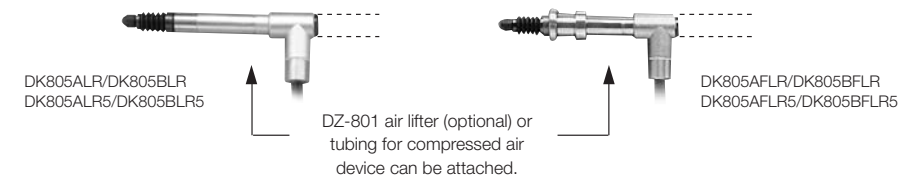
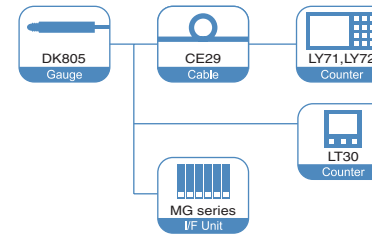

DK805ALR/DK805BLR
DK805AFLR/DK805BFLR

Digital Gauge

Dimensions

DK805AFLR/DK805BFLR
DK805AFLR5/DK805BFLR5

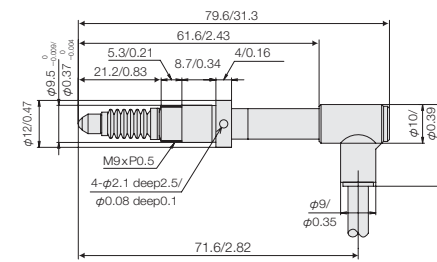

DK805AFR/DK805BFR
DK805AFR5/DK805BFR5

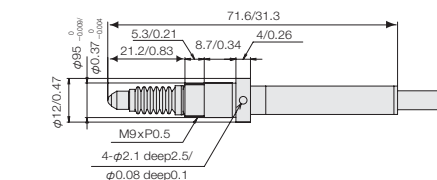

DK805ALR/DK805BLR
DK805ALR5/DK805BLR5

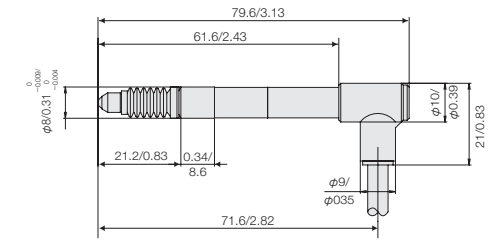

DK805AR/DK805BR
DK805AR5/DK805BR5

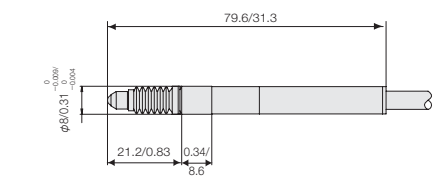

Unit : mm/inch

*Please refer to p54 for the details of the screw.

Specifications DK805 Series

| Model | High-resolution models | | General-purpose resolution model | |
|--|--|--|---|--|
| | DK805AFR, DK805AFLR, DK805AR, DK805ALR | DK805BFR, DK805BFLR, DK805BR, DK805BLR | DK805AFR5, DK805AFLR5, DK805AR5, DK805ALR5 | DK805BFR5, DK805BFLR5, DK805BR5, DK805BLR5 |
| Output | A/B/Z phase voltage-differential line driver output (compliant with EIA-422) *Please see P17 Output Signal Phase Difference. | | | |
| Signal pitch | 40 μm | | | |
| Resolution | 0.1 μm | | 0.5 μm | |
| Measuring range | 5 mm (0.19") | | 5 mm | |
| Accuracy (at 20°C/68°F) | 1 μm | | 1.5 μm | |
| Measuring force (at 20°C/68°F) | Downward: 0.45 ± 0.25 N Horizontal: 0.40 ± 0.25 N Upward: 0.35 ± 0.25 N | | | |
| Reference point | One location (at 1 mm/0.04" position of spindle movement) | | | |
| Maximum response speed | 80 m/min | 42 m/min | 250 m/min | 100 m/min |
| Air driving | Vacuum suction (DK805AFLR / DK805AFLR5 / DK805BFLR / DK805BFLR5 / DK805ALR / DK805ALR5 / DK805BLR5) | | | |
| Vibration resistance (10 to 2000 Hz) | 100 m/s ² | | | |
| Shock resistance (11 ms) | 1000 m/s ² | | | |
| Protective structure | IP66 (not including interpolation box and connectors) | | | |
| Operating temperature | 0°C to 50°C/32°F to 122°F | | | |
| Storage temperature | -20°C to 60°C/-4°F to 140°F | | | |
| Power supply voltage | DC +5 V ±5% | | | |
| Power consumption | 1 W | | | |
| Cable length ¹ | 2.5 m/8.2' | | | |
| Diameter of stem | φ 9.52 / 0.37" dia. | | | |
| Mass ² | Approx. 30 g/1.06 oz | | | |
| Feeler | Provided with a carbide ball tip (DZ-123) Mount screw M2.5 | | Provided with a steel ball tip Mount screw M2.5 | |
| Accessories | Installation spacer, Instruction Manual, Supplement | | | |
| Output cable length (up to the electronic section) | 22 m/72.2' max. | | | |

*1: Please refer to P10 DK 802 A/B about the extension cable (Option).

*2: The mass indicated is the total mass excluding the cable and interpolation box.

DK

DK812A/B Series

High accuracy, rugged gauges.
Suitable for installation on machines.

- Measuring range: 12 mm ● Accuracy: 1 μm, 1.5 μm ● Resolution: 0.1 μm, 0.5 μm
- Max. response speed: 80m/min (Resolution: 0.1 μm)
250m/min (Resolution: 0.5 μm)
- Built-in reference point ● Excellent resistance to workshop conditions.
- Robust design for harsh environments.

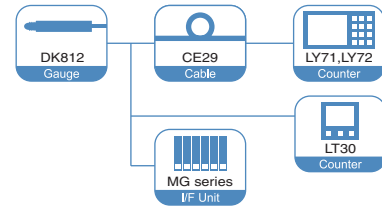

DK812AR/DK812AR5/
DK812BR/DK812BR5



DK812AFLR/DK812AFLR5
DK812ABLR/DK812BFLR5

Digital Gauge

Dimensions

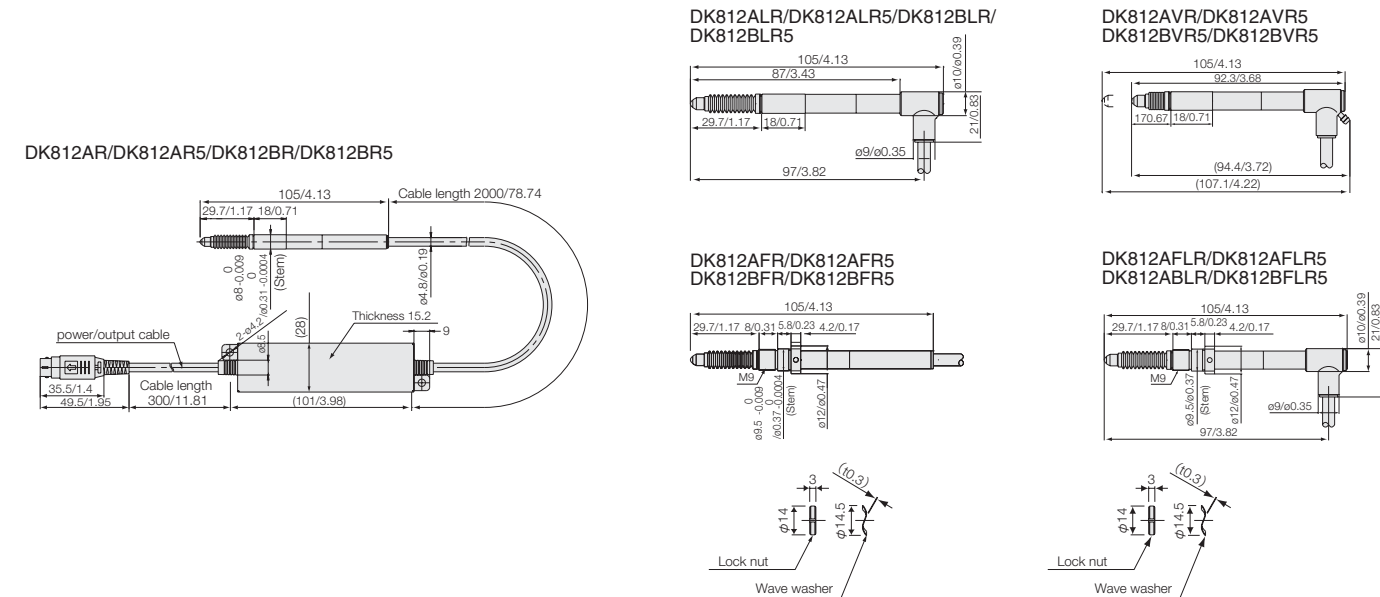

*Please refer to p54 for the details of the screw.

| Specifications DK812 Series | | | | |
|---|---|--|--|---|
| Model | High-resolution models | | General-purpose resolution models | |
| | DK812AR, DK812ALR, DK812AFR, DK812AFLR, DK812AVR | DK812BR, DK812BLR, DK812BFR, DK812BFLR, DK812BVR | DK812AR5, DK812ALR5, DK812AFR5, DK812AFLR5, DK812AVR5 | DK812BR5, DK812BLR5, DK812BFR5, DK812BFLR5, DK812BVR5 |
| Output | A/B/Z phase voltage-differential line driver output (compliant with EIA-422) | | | |
| Signal pitch | 40 μm | | | |
| Resolution | 0.1 μm | | 0.5 μm | |
| Measuring range | 12 mm (0.47") | | | |
| *Accuracy (at 20°C / 68°F) | 1 μm | | 1.5 μm | |
| Measuring force (at 20°C / 68°F) | Downward: 0.6 ± 0.3 N Horizontal: 0.5 ± 0.3 N Upward: 0.4 ± 0.3 N | | Air pressure of 0.03Mpa : 1N or less in all directions Air pressure of 0.04Mpa : 1.7N or less in all directions | |
| Reference point | One location (at 1 mm/0.04" position of spindle movement) | | | |
| Maximum response speed | 80 m/min | 42 m/min | 250 m/min | 100 m/min |
| Air driving | Vacuum suction (DK812AFLR / DK812AFLR5 / DK812BFLR / DK812BFLR5) Pneumatic push type (DK812AVR / DK812AVR5 / DK812BVR / DK812BVR5) | | | |
| Vibration resistance (10 to 2000 Hz) | 100m/s ² | | | |
| Impact resistance (11 ms) | 1000m/s ² | | | |
| Protective structure | IP66 (not including interpolation box and connectors) | | | |
| Operating temperature | 0°C to 50°C/32°F to 122°F | | | |
| Storage temperature | -20°C to 60°C/-4°F to 140°F | | | |
| Power supply voltage | DC +5 V ±5% | | | |
| Power consumption | 1 W | | | |
| Cable length ² | 2.5 m/8.2' | | | |
| Diameter of stem | φ9.5 ^{0.009} / _{0.37} ⁰ / _{0.0004} dia., φ*8 / 0.31" dia. (Pneumatic push type) | | | |
| Mass ¹ | Approx. 30 g/1.06 oz | | | |
| Feeler | Provided with a carbide ball tip (DZ-123) Mount screw M2.5 | | Provided with a steel ball tip Mount screw M2.5 | |
| Accessories | +P M4x5 screw (2pcs.), Installation spacer, Instruction Manual, Supplement | | | |
| *Output cable length (up to the electronic section) | 22 m/72.2' max. | | | |

*1 : Please refer to P10 DK 802 A/B about the extension cable (Option).
*2 : The mass indicated is the total mass excluding the cable and interpolation box.

DK

DK10/25 Series

High accuracy, rugged gauges.
Suitable for installation on machines.

- Measuring range : 10 mm / 0.39" and 25 mm / 0.98" ● Accuracy : 2 μm
- Resolution : 0.5 μm ● Excellent resistance to workshop conditions.
- High measuring force (10PR5/10PLR5/25PR5/25PLR5)
- Low measuring force (10NR5/25NR5/25NLR)
- A variety of accessories available (See "Accessories for Gauges")
- Direct connected to A/B quadrature counter

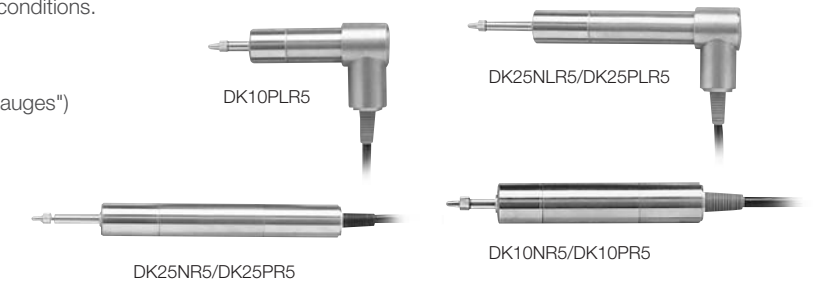
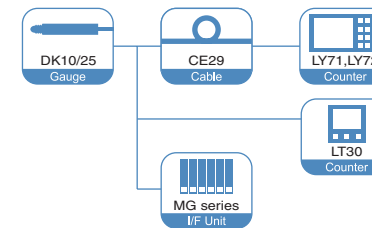

Digital Gauge

Dimensions

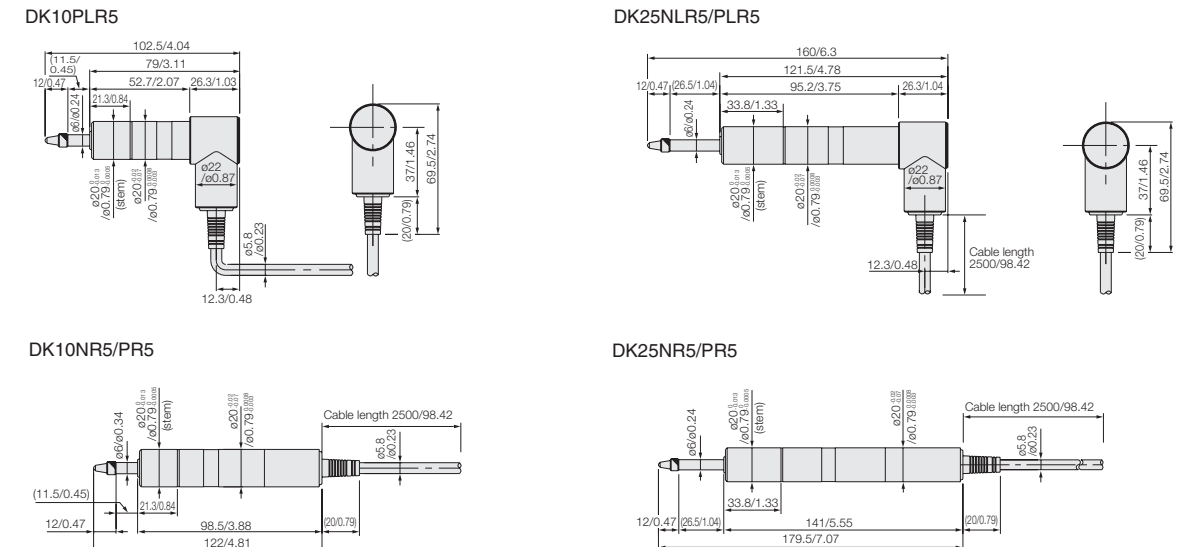

Unit : mm/inch

| Specifications | | | | | | | |
|--------------------------------------|--|--------------|---------------|---------------|---------------|--------------|---------------|
| Model | DK10NR5 | DK10PR5 | DK10PLR5 | DK25NR5 | DK25PR5 | DK25NLR5 | DK25PLR5 |
| Output | A/B/Z phase voltage-differential line driver output (compliant with EIA-422) *Please see P17 Output Signal Phase Difference. | | | | | | |
| Resolution ¹ | 0.5 μm | | | | | | |
| Measuring range | 10 mm | | | 25 mm | | | |
| Accuracy (at 20°C) | 2 μm | | | | | | |
| Measuring force (at 20°C) | Upward | 0.3 ± 0.25 N | 4.9 N or less | 0.4 ± 0.3 N | 4.9 N or less | 0.4 ± 0.3 N | 4.9 N or less |
| | Horizontal | 0.6 ± 0.3 N | | 0.7 ± 0.35 N | | 0.7 ± 0.35 N | |
| | Downward | 0.8 ± 0.35 N | | 1 ± 0.4 N | | 1 ± 0.4 N | |
| Reference point | One location (at 1 mm position of spindle movement) | | | | | | |
| Maximum response speed | 250 m/min | | | | | | |
| Vibration resistance (10 to 2000 Hz) | 150 m/s ² | | | | | | |
| Impact resistance (11 ms) | 1500 m/s ² | | | | | | |
| Protective structure | IP50 | IP64 | | IP50 | IP64 | IP50 | IP64 |
| Operating temperature | 0°C to 50°C | | | | | | |
| Storage temperature | -20°C to 60°C | | | | | | |
| Power supply voltage | DC +5 V ±5% | | | | | | |
| Power consumption | 1 W or less | | | | | | |
| Cable length ² | Approx. 2.5 m | | | | | | |
| Diameter of stem | φ20 ^{0.013} / _{0.23} mm | | | | | | |
| Mass ³ | Approx. 230 g | | | Approx. 300 g | | | |
| Feeler | Provided with a carbide ball tip DZ-122 (Mount screw M2.5) | | | | | | |
| Output cable length | 22 m max. | | | | | | |
| Guaranteed number of Strokes | Minimum 5 million cycles without shock | | | | | | |
| Accessories | +P M4x5 screw (2 pcs.), Instruction Manual | | | | | | |

*1 : The resolution setting needs to be made when connecting to the LT30 series, MG series, and LY70 series. For details, please refer to the respective instruction manual.
*2 : Please refer to P10 DK 802 A/B about the extension cable (Option).
*3 : The mass indicated is the total mass excluding the cable and interpolation box.

DK

DK50/100 Series

High accuracy, rugged gauges.
Suitable for installation on machines.

- Measuring range : 50 mm / 1.97", 100 mm / 3.94"
- Accuracy : 2 μm (DK50PR5/50NR5), 4 μm (DK100PR5/100NR5)
- Resolution : 0.5 μm ● Excellent resistance to workshop conditions.
- High measuring force (DK50PR5/100PR5) ● Low measuring force (DK50NR5/100NR5)
- Direct connected to A/B quadrature counter

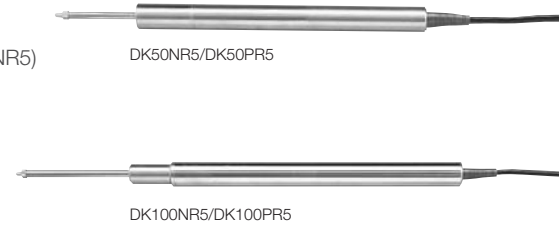
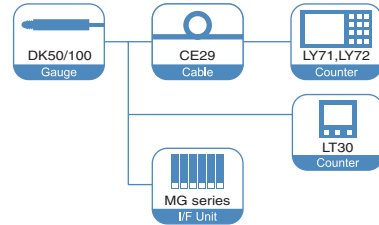

Digital Gauge

Dimensions

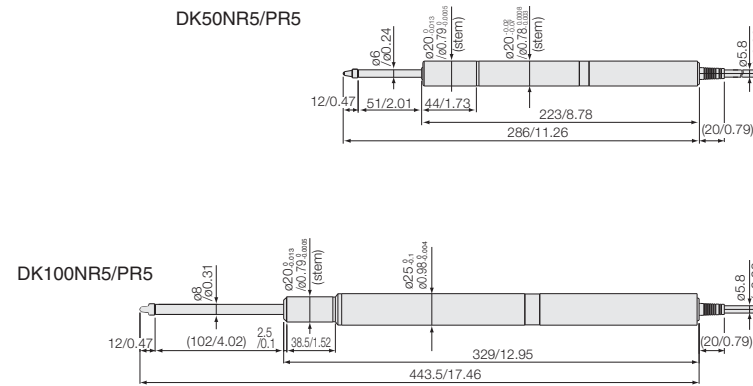

Unit : mm/inch

| Specifications | | | | |
|--------------------------------------|--|-------------|---------------|--|
| Model | DK50NR5 | DK50PR5 | DK100NR5 | DK100PR5 |
| Output | A/B/Z phase voltage-differential line driver output (compliant with EIA-422) *Please see P17 Output Signal Phase Difference. | | | |
| Resolution*1 | 0.5 μm | | | |
| Measuring range | 50 mm | | 100 mm | |
| Accuracy (at 20°C) | 2 μm | | 4 μm | |
| Measuring force (at 20°C) | Upward | — | — | — |
| | Horizontal | 0.9 ± 0.4 N | 4.9 N or less | 1.8 ± 0.65 N |
| | Downward | 1.3 ± 0.5 N | 4.9 N or less | 2.7 ± 0.55 N |
| Reference point | One location (at 1 mm position of spindle movement) | | | |
| Maximum response speed | 250 m/min | | | |
| Vibration resistance (10 to 2000 Hz) | 150 m/s ² | | | |
| Impact resistance (11 ms) | 1500 m/s ² | | | |
| Protective structure | IP50 | IP64 | IP50 | IP64 |
| Operating temperature | 0°C to 50°C | | | |
| Storage temperature | -20°C to 60°C | | | |
| Power supply voltage | DC +5 V ±5% | | | |
| Power consumption | 1 W or less | | | |
| Cable length*2 | Approx. 2.5 m | | | |
| Diameter of stem | ø 20 ⁰ _{-0.013} mm | | | |
| Mass*3 | Approx. 360 g | | Approx. 630 g | |
| Feeler | Provided with a carbide ball tip DZ-122 (Mount screw M2.5) | | | Provided with a carbide ball tip DZ-121 (Mount screw M2.5) |
| Output cable length | 22 m max. | | | |
| Guaranteed number of Strokes | Minimum 5 million cycles without shock | | | |
| Accessories | +P M4x5 screw (2 pcs.), Instruction Manual | | | |

*1 : The resolution setting needs to be made when connecting to the LT30 series, MG series, and LY70 series. For details, please refer to the respective instruction manual.
*2 : Please refer to P10 DK 802 A/B about the extension cable (Option).
*3 : The mass indicated is the total mass excluding the cable and interpolation box.

DK

DK155/205

High accuracy, rugged gauges.
Suitable for installation on machines.

- Measuring range : 155 mm / 6.1" and 205 mm / 8.07"
- Accuracy : 5 μm (DK155PR5), 6 μm (DK205PR5)
- Resolution : 0.5 μm ● Excellent resistance to workshop conditions.
- Magnet feeler (DG155BP/205BP)
- Direct connected to A/B quadrature counter

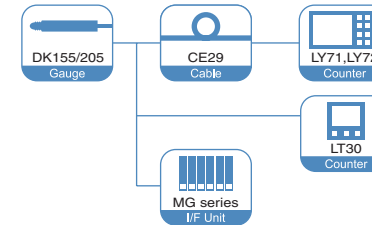

Digital Gauge

Dimensions

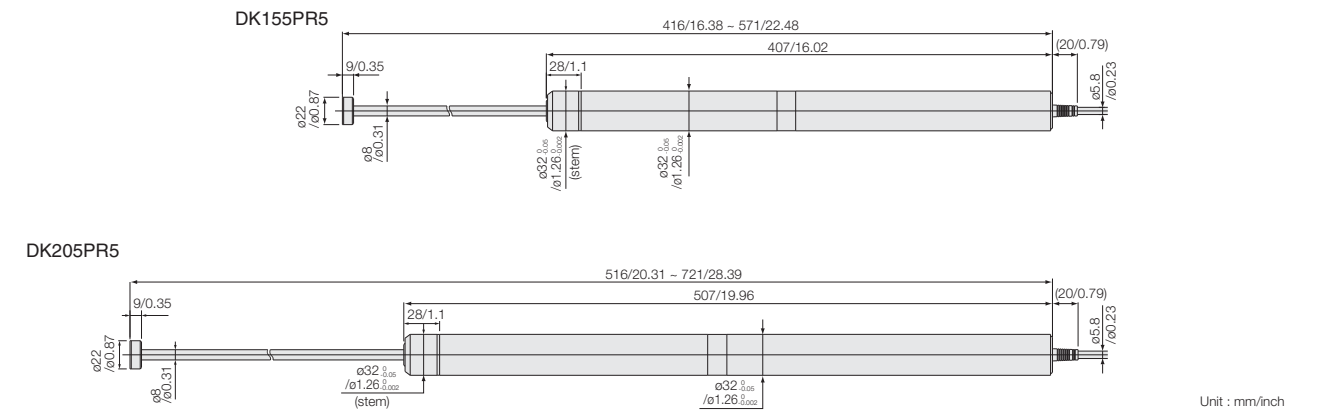

Unit : mm/inch

| Specifications | | |
|--------------------------------------|--|----------------|
| Model | DK155PR5 | DK205PR5 |
| Output | A/B/Z phase voltage-differential line driver output (compliant with EIA-422) *Please see P17 Output Signal Phase Difference. | |
| Resolution*1 | 0.5 μm | |
| Measuring range | 155 mm | 205 mm |
| Accuracy (at 20°C) | 5 μm | 6 μm |
| Reference point | One location (at 5 mm position of spindle movement) | |
| Maximum response speed | 250 m/min | |
| Vibration resistance (10 to 2000 Hz) | 150 m/s ² | |
| Impact resistance (11 ms) | 1500 m/s ² | |
| Protective structure | IP64 | |
| Operating temperature | 0°C to 50°C | |
| Storage temperature | -20°C to 60°C | |
| Power supply voltage | DC +5 V ±5% | |
| Power consumption | 1 W or less | |
| Cable length*2 | Approx. 2.5 m | |
| Diameter of stem | ø32 ⁰ _{-0.05} mm | |
| Mass*3 | Approx. 1100 g | Approx. 1300 g |
| Feeler mounting base | Magnetic substance | |
| Magnetically attachable feeler | Magnetic attraction: 10 N, resistance against horizontal slip: 2.7 N Provided with ø4 mm carbide ball tip | |
| Spindle*4 | ø 8 mm, radial swing: 0.04 mm max. | |
| Output cable length | 22 m max. | |
| Guaranteed number of Strokes | Minimum 5 million cycles without shock | |
| Accessories | +P M4x5 screw (2 pcs.), Instruction Manual | |

*1 : The resolution setting needs to be made when connecting to the LT30 series, MG series, and LY70 series. For details, please refer to the respective instruction manual.
*2 : Please refer to P10 DK 802 A/B about the extension cable (Option).
*3 : The mass indicated is the total mass excluding the cable and interpolation box.
*4 : The spindle weighs about 400g.

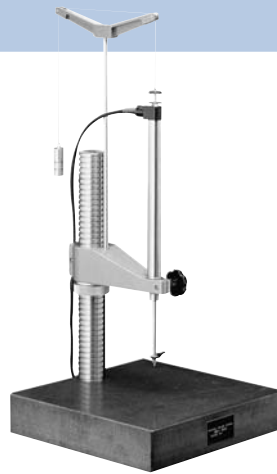

- Measuring range :110 mm / 4.33" ● Accuracy: 4 μm ● Resolution: 0.5 μm
- Direct connected to A/B quadrature counter ● Reduced measurement error
- Precision dual spindle support allows for a smooth spindle motion and virtually error free measurements.
- Reduced measuring force

The measuring force can be reduced to a minimum of 0.3 N in three selectable steps using the measuring balancer (option). The force is maintained constant regardless of spindle movement direction.

- Soft spindle return. A braking mechanism reduces spindle return speed, thereby eliminating the danger of damaging either the surface plate or the workpiece.

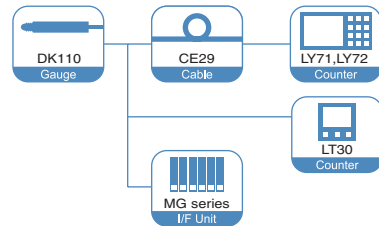

*Digital gauge stand DZ-531 and Measuring force balancer DZ-581 are option.

Digital Gauge

Dimensions

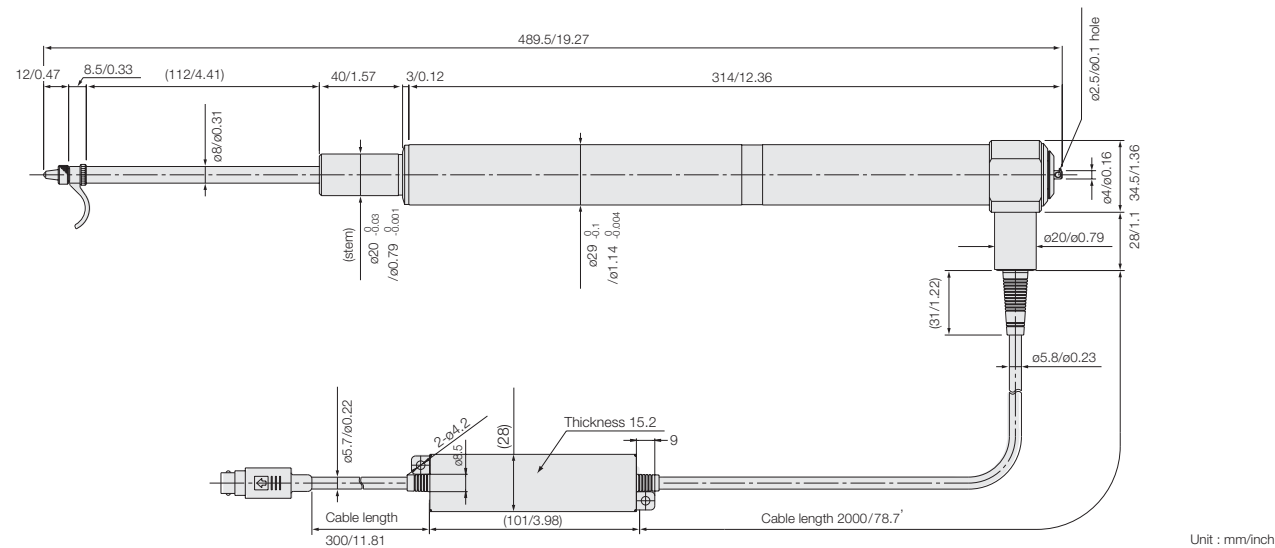

Unit : mm/inch

| Specifications | |
|--------------------------------------|--|
| Model | DK110NLR5 |
| Output | A/B/Z phase voltage-differential line driver output (compliant with EIA-422) *Please see P17 Output Signal Phase Difference. |
| Resolution*1 | 0.5 μm |
| Measuring range | 110 mm |
| Accuracy (at 20°C) | 4 μm |
| Reference point | One location (at 5 mm position of spindle movement) |
| Maximum response speed | 250 m/min |
| Vibration resistance (10 to 2000 Hz) | 150 m/s ² |
| Impact resistance (11 ms) | 1500 m/s ² |
| Protective structure | IP50 |
| Operating temperature | 0°C to 50°C |
| Storage temperature | -20°C to 60°C |
| Power supply voltage | DC +5 V ±5% |
| Power consumption | 1 W or less |
| Cable length*2 | Approx. 2.5 m |
| Diameter of stem | ø20 ±0.013 mm |
| Mass*3 | Approx. 800 g |
| Feeler | DZ-121 (Mount screw M2.5) |
| Output cable length | 22 m max. |
| Guaranteed number of Strokes | Minimum 5 million cycles without shock |
| Accessories | +P M4x5 screw (2 pcs.), feeler DZ-121, lift lever DZ-161, Instruction Manual |

*1 : The resolution setting needs to be made when connecting to the LT30 series, MG series, and LY70 series. For details, please refer to the respective instruction manual.

*2 : Please refer to P10 DK 802 A/B about the extension cable (Option).

*3 : The mass indicated is the total mass excluding the cable and interpolation box.

DK Series operating cautions

In operating the feeler with a vacuum pump, use such an air-pass system as shown in Fig. 1 to enable air driving. The optimum vacuum rate is 0.04 to 0.067MPa. Further, put such an orifice as shown in Fig. 2 on a tube from the air lifter connector to control the air suction and discharge speed. The feeler is lifted at the air discharge to the vacuum pump.

Fig.1 Air-pass System

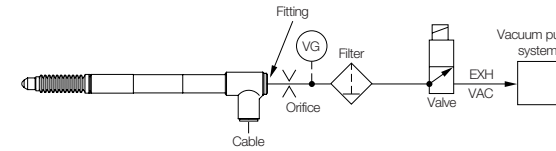
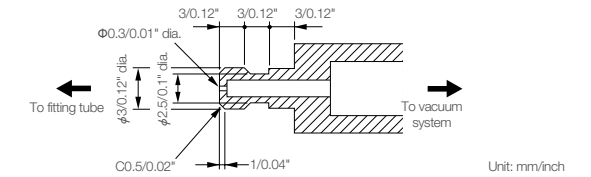
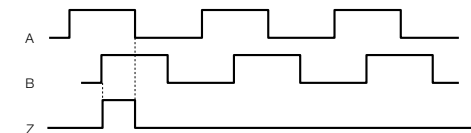

Fig.2 Dimensions of Orifice



DK Series measuring unit output signals

The signals output from this measuring unit are A/B quadrature signal, Z signal in the form of voltage-differential line driver output compliant with EIA-422.



When connecting with MG40 series measuring system, output signal have to change to the serial output from A/B output by a switch on interpolation box.

The reference point is the synchronized reference point that is at Hi impedance when the phase A and phase B are at the Hi level.

DK800A output signals at maximum response speed (at approx. 80 m/min)

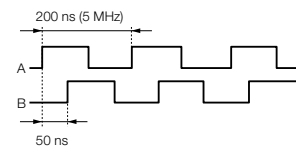

DK800B output signals at maximum response speed (at approx. 42 m/min)

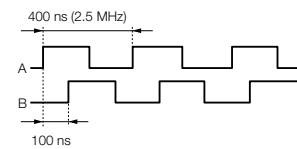

DK10/25/100/155/205/110 Output signals at maximum response speed (at approx. 42 m/min)

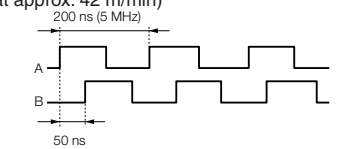

Before using, check that the minimum input phase difference of the control device connected to this measuring unit or the counter is smaller than 50 ns for the DK800A (A signal cycle: 200 ns, 5 MHz) or smaller than 100 ns for the DK800B (A cycle: 400 ns, 2.5 MHz).

Before using, check that the minimum input phase difference of the control device connected to this measuring unit or the counter is smaller than 50 ns for-DK 10-110 series (A signal cycle: 200 ns, 5 MHz).

*The minimum phase difference can be modified under special specifications.

*The minimum phase difference can be modified under special specifications.

Output Signal Phase Difference

The travel amount of the measuring unit is detected every 50 ns for the DK800A and every 100 ns for the DK800B, and the phase difference proportional to the amount traveled is output. The phase difference changes in integer multiples of 50 ns or 100 ns. Also, the minimum phase difference for the A and B is 50 ns for the DK800A and 100 ns for the DK800B.

The travel amount of the measuring unit is detected every 50 ns, and the phase difference proportional to the amount traveled is output. The phase difference changes in integer multiples of 50 ns. Also, the minimum phase difference for the A and B is 50 ns.

DK802A/B-812A/B

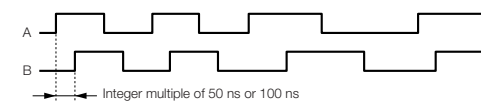

DK10/25/100/155/205/110

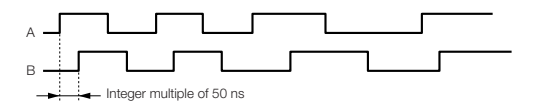

In maximum standard specifications, the minimum phase difference is fixed at 50 ns for the DK800A and 100 ns for the DK800B, but the minimum phase differences in the table below are available as special specifications.

In the standard specifications, the minimum phase difference is fixed at 50 ns, but the minimum phase differences in the table below are available as special specifications.

| A/B minimum phase difference | A signal cycle | Counter allowable frequency | Maximum response speed | | Remarks |
|------------------------------|----------------|-----------------------------|------------------------|-------------------|-------------------------|
| | | | Resolution 0.1 μm | Resolution 0.5 μm | |
| 50 ns | 200 ns | 5 MHz | 80 m/min | 250 m/min | DK800A standard product |
| 100 ns | 400 ns | 2.5 MHz | 42 m/min | 100 m/min | DK800B standard product |
| 300 ns | 1.2 μs | 833 kHz | 14 m/min | 33 m/min | Special specifications |
| 500 ns | 2 μs | 500 kHz | 8.4 m/min | 20 m/min | Special specifications |

| A/B minimum phase difference | A signal cycle | Counter allowable frequency | Maximum response speed Resolution 0.5 μm | Remarks |
|------------------------------|----------------|-----------------------------|--|------------------------|
| | | | | |
| 100 ns | 400 ns | 2.5 MHz | 100 m/min | Special specifications |
| 300 ns | 1.2 μs | 833 kHz | 33 m/min | Special specifications |
| 500 ns | 2 μs | 500 kHz | 20 m/min | Special specifications |

Output Signal Alarm

If the response speed is exceeded, the A/B output from this measuring unit changes to Hi impedance for about 400 ms to serve as an alarm.

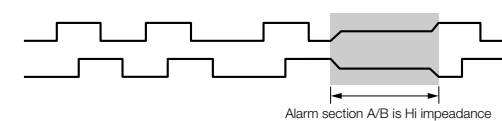

Receiver

DK10/25/100/155/205/110

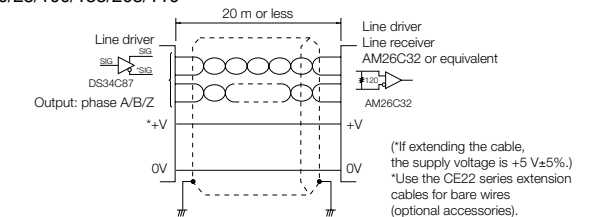

(If extending the cable, the supply voltage is +5 V±5%.) *Use the CE22 series extension cables for bare wires (optional accessories).

Accessories (for DK and DG series)

DZ-122 Feeler (for DK Series, DG10B and DG50B)

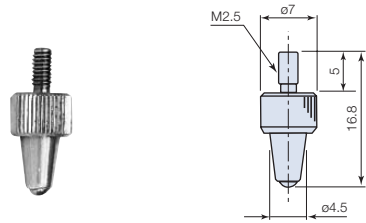

- Contact point: $\phi 2.5$ mm/0.098" carbide ball tip (mounting screw: M2.5 x 0.45)

Unit : mm

DZ-123 Feeler (for DK Series, DG805BL/810B/810BL)

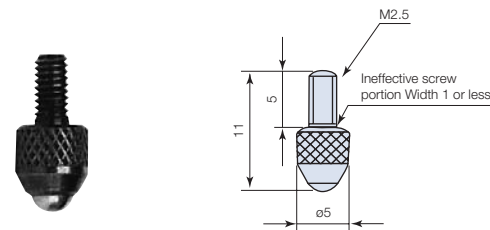

- Contact point: $\phi 3$ mm/0.118" carbide ball tip (mounting screw: M2.5 x 0.4)

Unit : mm

DZ-531 Digital gauging stand (for DK110, DG110B)



- Surface plate material: gabbro
- Surface plate flatness: 3 μ m
- Surface plate size: 350mm (13.78") x 350mm (13.78")
- Maximum workpiece height: approx. 330mm (12.99")
- Gauge mounting hole: $\phi 20$ mm (0.79")
- Mass: 38kg(83.8 lbs)

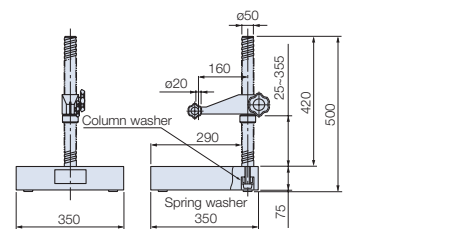

Unit : mm

DZ-581 Measuring force balancer (for DK110, DG110B)

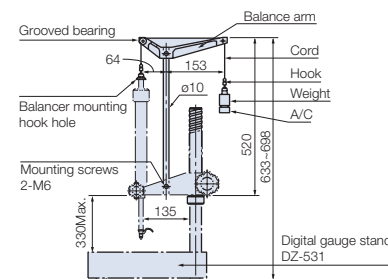

Unit : mm

Weight

- No weight: 1.55 \pm 0.15N(155 \pm 15gf)
- B: 1.0 \pm 0.15N(100 \pm 15gf)
- B+A: 0.7 \pm 0.15N(70 \pm 15gf)
- B+C: 0.3 \pm 0.15N(30 \pm 15gf)

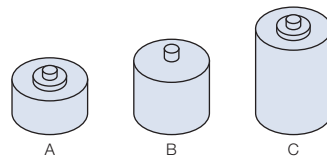

DZ-121 Feeler (for DK100, DG100BP/BN)

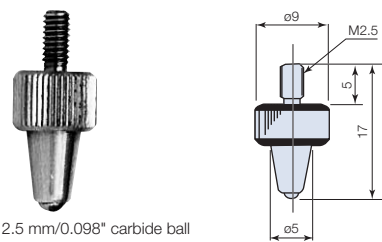

- Contact point: $\phi 2.5$ mm/0.098" carbide ball tip (mounting screw: M2.5 x 0.45)

Unit : mm

Other accessories

- CE08 Extension cable : CE08-01 (1m) , 03 (3m) , 05 (5m) , 10 (10m) , 15 (15m)
- CE22 Extension cable (Ahead in pieces) : CE22-01 (1m) , 03 (3m) , 05 (5m) , 10 (10m)
- CK-T Extension cable (Winding-proof) : CK-T12 (1m) , T13 (3m) , T14 (5m) , T15 (10m)

*Please refer to p54 for the details of the screw.

DZ-191 Coupling

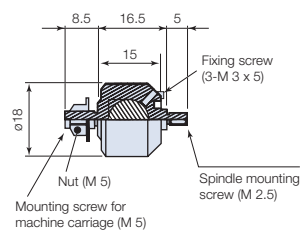

Unit : mm

DE

DE-BR Series

High precision digital gauge for submicron position detection and measuring

- Magnetic principle
- High accuracy: 1 µm
- High resolution: 0.1 µm
- Measuring range: 12 mm / 0.47" and 30 mm / 1.18"
- Built-in zero point
- Protective design grade: equivalent to IP64 with optional bellows.

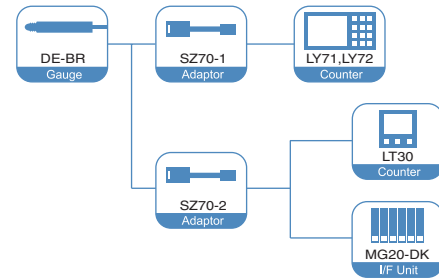

Digital Gauge

Dimensions

DE12BR

DE30BR

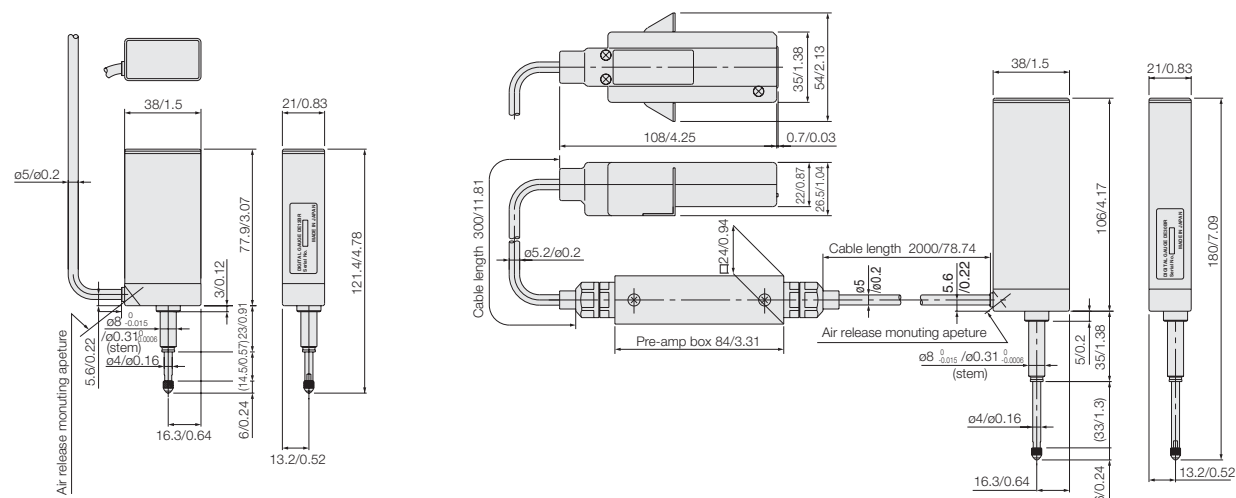

Unit : mm/inch

| Specifications | | DE12BR | DE30BR |
|-----------------------------|--|---|-------------------------|
| Model | | DE12BR | DE30BR |
| Measuring range | | 12 mm / 0.47" | 30 mm / 1.18" |
| Resolution | | 0.1 µm | |
| Accuracy (at 20 °C / 68 °F) | | 1 µm | |
| Maximum response speed | | 20 m/min zero point detection mode : 0.15/min | |
| Measuring force | Upward | 0.35 ± 0.2 N | 0.5 ± 0.3 N |
| | Lateral | 0.5 ± 0.2 N | 0.75 ± 0.3 N |
| | Downward | 0.7 ± 0.2 N | 1 ± 0.3 N |
| Zero point | 5 mm/0.2" from feeler end fully retracted | | |
| Protective design grade | Equivalent to IP64 (with optional bellows) | | |
| Mounting stem diameter | $\phi 8_{-0.015}^{0} / \phi 0.31_{-0.0006}^{0}$ | | |
| Operating temperature | 0 °C to 50 °C / 32 °F to 122 °F | | |
| Storage temperature | -10 °C to 60 °C / 14 °F to 140 °F | | |
| Power consumption | ±5V 100mA | | |
| Cable length | 2 m / 6.56' | | |
| Feeler | Feeler tipped with 3 mm dia. carbide ball with M2.5p x 0.45 screw on fitting end (DZ123) | | |
| Mass (excl. cable unit) | Approx.400 g / 14.11 oz | | Approx.450 g / 15.87 oz |

Accessories

DZ301 Bellows set (for DL330B, DE30BR)

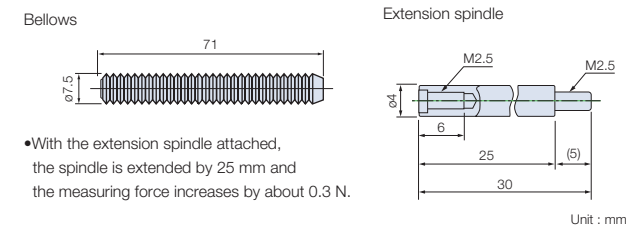

•With the extension spindle attached, the spindle is extended by 25 mm and the measuring force increases by about 0.3 N.

DZ501 Digital gauging stand (for U60B, DG10B to DG100B, DE-30BR)

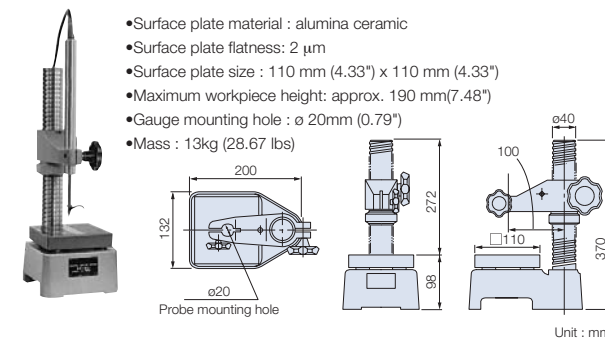

SZ70-1 Adapter

SZ70-1 is required for connecting the following scale units and counters:
 Gauge unit : DE-BR Series, DG-B Series
 Counter : LH71A, LH72-3, LY71 and LY72
 * Adapter DZ51 is also required

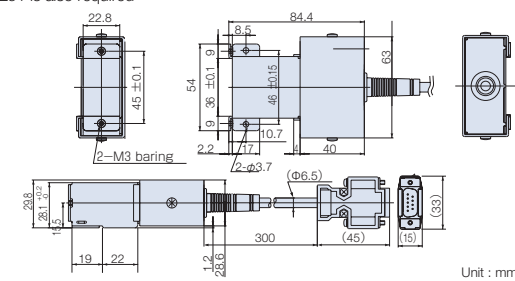

DZ302 Bellows set (for DE12BR)

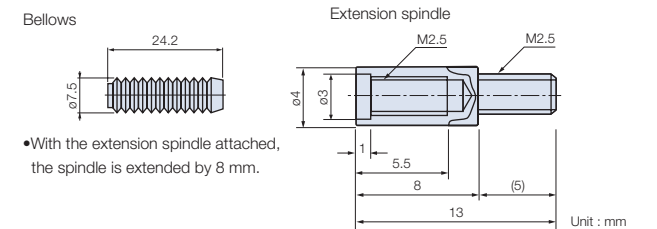

•With the extension spindle attached, the spindle is extended by 8 mm.

DZ521 Gauging stand (for DG805BL/810B/810BL, U Series, DE12BR)

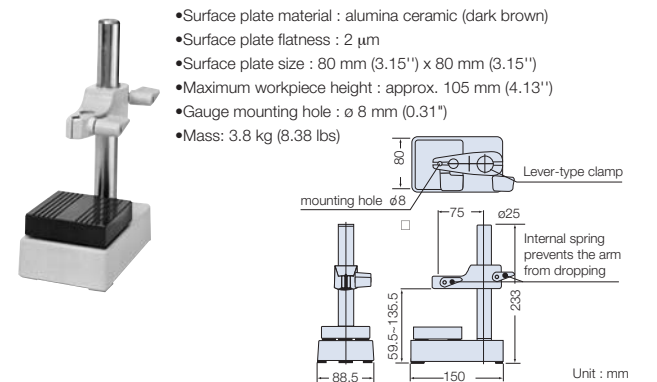

DZ-191 Coupling

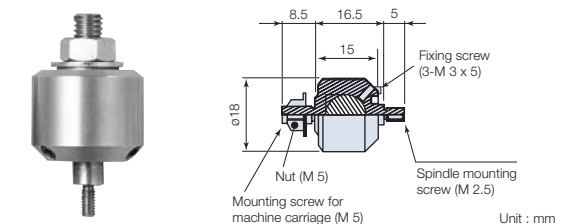

DZ-5100 Feeler set

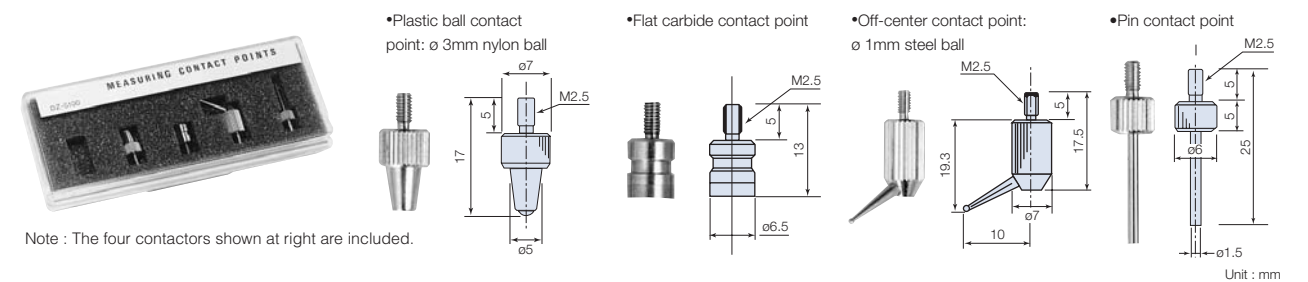

Note : The four contactors shown at right are included.

SZ70-2 Adapter

SZ70-2 is required for connecting the following scale units and counters:
 Gauge unit: DE-BR Counterunit: LT30 Interface unit: MG series

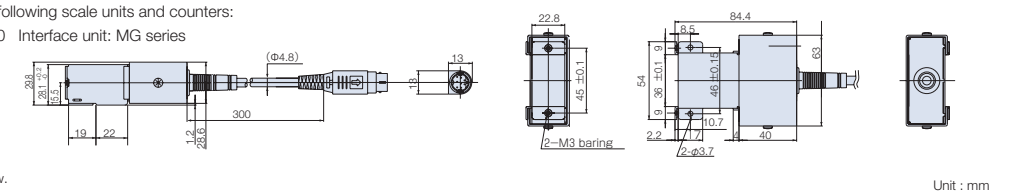

*Please refer to p54 for the details of the screw.

DG

DG805 Series, DG810 Series

High accuracy, compact, and slim gauges suitable for installation on machines.

- Magnetic principle ● Excellent resistance to workshop conditions. Resistant to oil, water, dust, vibration, and shock. ● Accuracy : 2 μm
- Resolution : 0.5 μm ● Measuring range: 5.2 mm / 0.20" and 10 mm / 0.39"
- Compact and slim: ø8 mm / ø0.31" (outer diameter) 74.5 mm / 2.93" (overall length) (DG805)
- Low measuring force
- Spindle can be moved vertically with an air pressure device (DG805BL/FL, DG810BL/FL).
- Dustproof bellows (standard).
- Easy installation. Flange type gauges also available.

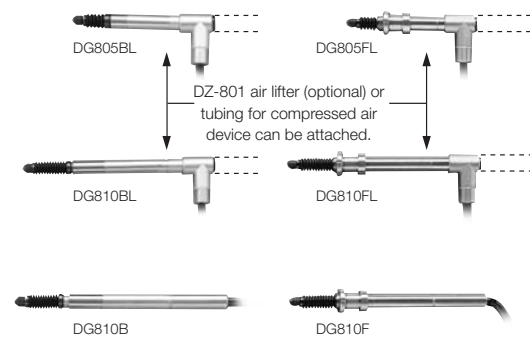
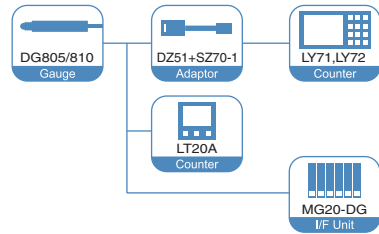

Digital Gauge

Dimensions

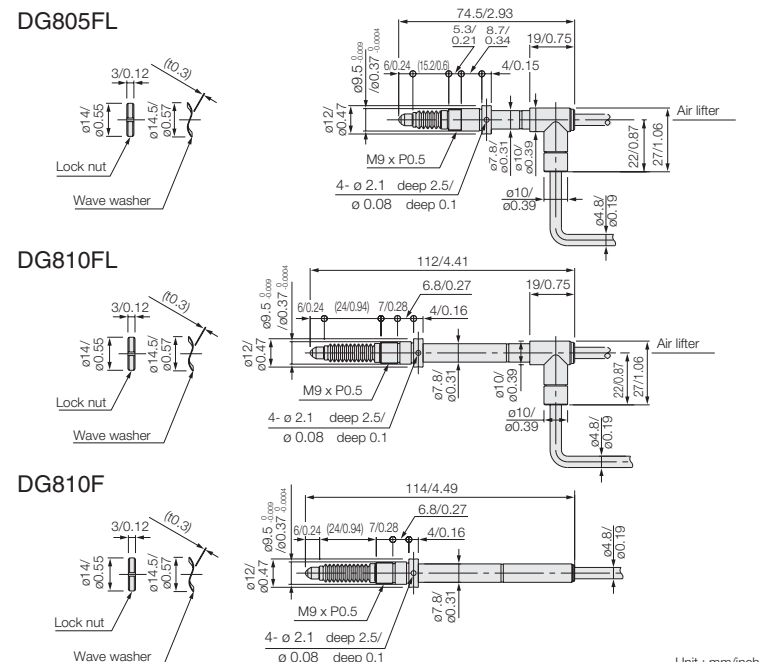
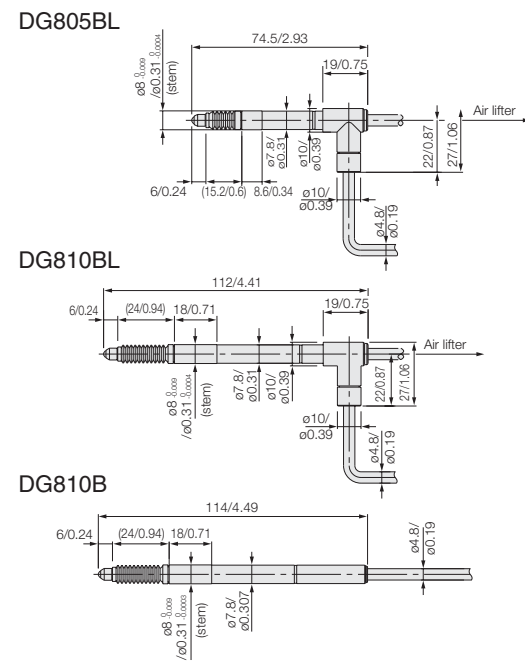

Unit : mm/inch

*Please refer to p54 for the details of the screw.

Specifications

| Model | DG805BL / FL / BLM / BLE / FLM / FLE | DG810B / F / BM / BE / FM / FE | DG810BL / FL / BLM / BLE / FLM / FLE |
|---------------------------|--|--------------------------------|--------------------------------------|
| Type | For Counter, A/B quadrature signal output type (See Page 26) | | |
| Measuring range | 5.2 mm / 0.20" | 10 mm / 0.39" | |
| Resolution | 0.5 μm | | |
| Measuring range force | Upward | 0.35 ± 0.25 N | 0.4 ± 0.3 N |
| | Lateral | 0.4 ± 0.25 N | 0.5 ± 0.3 N |
| | Downward | 0.45 ± 0.25 N | 0.6 ± 0.3 N |
| Accuracy (at 20°C / 68°F) | 2 μm | | |
| Maximum Response speed | 1m/s | | |
| Operating temperature | 0 °C to 50 °C / 32 °F to 122 °F (gauge) | | |
| Storage temperature | -20 °C to 60 °C / -4 °F to 140 °F | | |
| Cable length | 5 m / 16.4' | | |
| Mounting stem diameter | ø 8 ^{0.009} mm / ø 0.31 ^{±0.0004} " F type: ø 9.5 ^{0.009} mm / ø 0.37 ^{±0.0004} " | | |
| Feeler | Feeler tipped with ø 3 mm / 0.12" dia. Carbide ball with M2.5 x 0.45 screw on fitting end (DZ-123) | | |
| Mass*1 | Approx.20 g / 0.71 oz | Approx.40 g / 1.41 oz | |
| Air lifter | Air lifter DZ-801 mountable*2 | — | Air lifter DZ-801 mountable*2 |

*1 excl. cable unit and Interpolator unit.
*2 Tubing for compressed air device can be attached.

DG

DG10_B, DG25_B

High accuracy, rugged gauges. Suitable for installation on machines.

- Excellent resistance to workshop conditions (BP/BS : IP64). Resistant to oil, water, dust, vibrations, and shocks.
- Accuracy : 2 μm ● Resolution : 0.5 μm
- Measuring range : 10 mm / 0.39" and 25 mm / 0.98"
- High measuring force (BP/BS)
- Low measuring force (BN/BL) ● Easy installation
- A variety of accessories available (See "Accessories for Gauges")

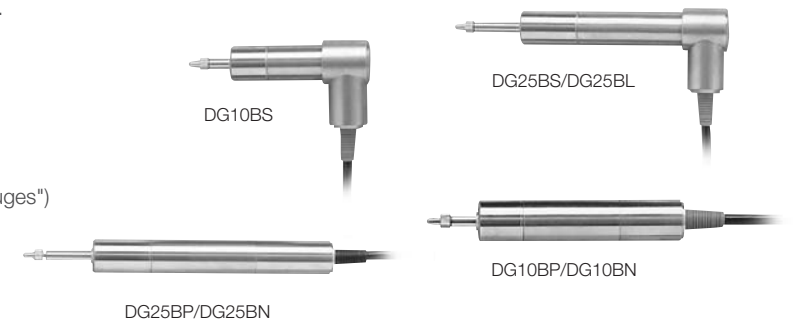
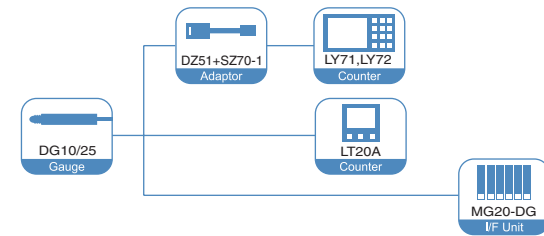

Digital Gauge

Dimensions

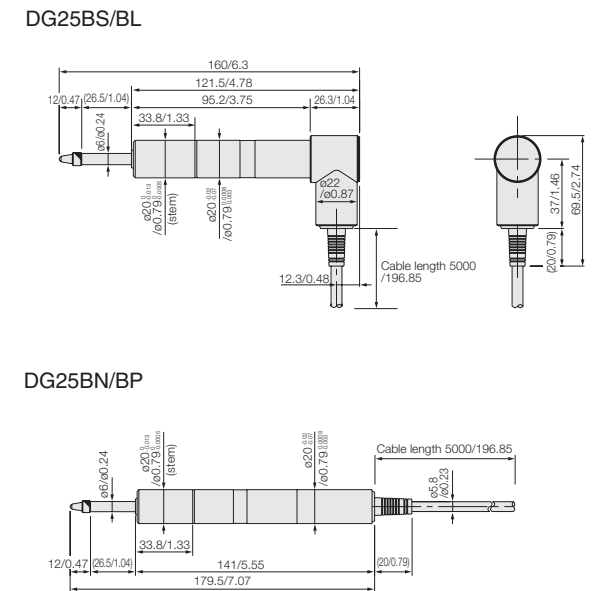
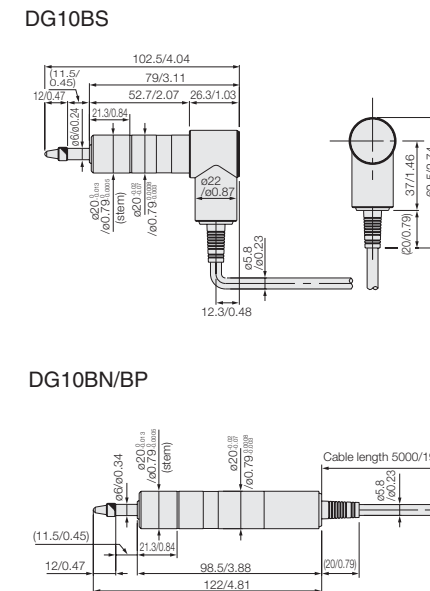

Unit : mm/inch

Specifications

| Model | DG10BP BPM / BPE | DG10BS BSM / BSE | DG10BN BNM / BNE | DG25BP BPM / BPE | DG25BS BSM/BSE | DG25BN BNM/BNE | DG25BL BLM/BLE |
|----------------------------|--|------------------------------|----------------------|---------------------------------|-------------------|-------------------|-------------------|
| Type | For Counter, A/B quadrature signal output type (See Page 26) | | | | | | |
| Measuring range | 10 mm / 0.39" | | | 25 mm / 0.98" | | | |
| Resolution | 0.5 μm | | | 0.5 μm | | | |
| Measuring range force | Upward | All direction: 4.9 N or less | | 0.3 ± 0.25 N | | 0.4 ± 0.3 N | |
| | Lateral | | | 0.6 ± 0.3 N | | 0.7 ± 0.35 N | |
| | Downward | | | 0.8 ± 0.35 N | | 1 ± 0.4 N | |
| Accuracy (at 20°C / 68°F) | 2 μm | | | | | | |
| Maximum Response speed | 1m/s | | | | | | |
| Operating temperature | 0 °C to 50 °C / 32 °F to 122 °F (gauge) | | | | | | |
| Storage temperature | -20 °C to 60 °C / -4 °F to 140 °F | | | | | | |
| Cable length | 5 m / 16.4' | | | | | | |
| Mounting stem diameter | ø 20 mm / ø 0.79" | | | | | | |
| Feeler | Feeler ø 2.5 mm carbide ball with M2.5p x 0.45 screw on fitting end (DZ-122) | | | | | | |
| Protective design grade | Equivalent to IP64 | | — | Equivalent to IP64 | | — | |
| Sealing (oil, water, dust) | Oil sealing, O-rings, Y-gaskets | | — | Oil sealing, O-rings, Y-gaskets | | — | |
| Mass*1 | Approx.230 g / 0.507 lbs | | | Approx.300 g / 0.661 lbs | | | |
| Lift lever | — | DZ-161 (option) | | — | | DZ-161 (option) | |
| Air lifter | DZ174-010 (option)*2 | | DZ174-025 (option)*2 | | | | — |

*1 excl. cable unit and Interpolator unit.
*2 Tubing for compressed air device can be attached.

DG

DG50_B, DG100_B, DG155_B, DG205_B Series

High accuracy, rugged gauges.
Suitable for installation on machines.

- Excellent resistance to workshop conditions (BP : IP64). Resistant to oil, water, dust, vibrations. and shocks.
- Accuracy: 2 μm (DG50BP/50BN), 4 μm (DG100BP/100BN), 5 μm (DG155BP), 6 μm (DG205BP) ● Resolution : 0.5 μm
- Measuring range: 50 mm / 1.97", 100 mm / 3.94", 155 mm / 6.1" and 205 mm / 8.07"
- High measuring force (DG50BP/100BP) ● Low measuring force (DG50BN/100BN)
- Magnet feeler (DG155BP/205BP) ● Easy installation
- A variety of accessories available (See "Accessories for Gauges")

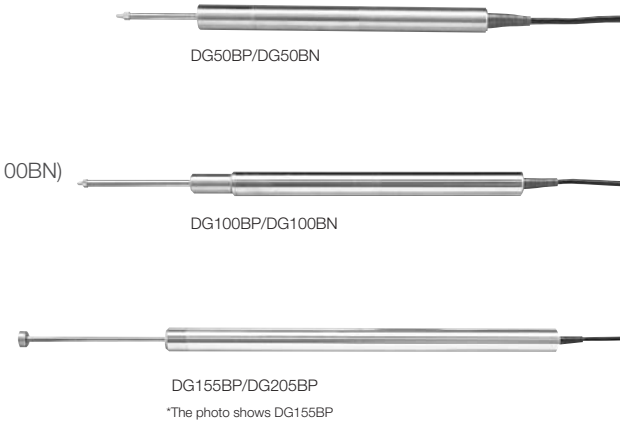
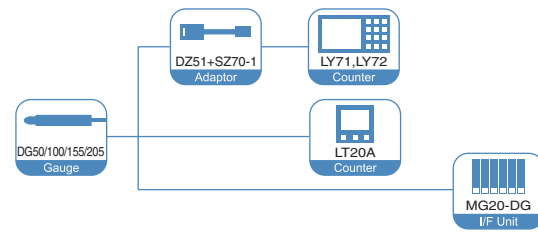

Digital Gauge

Dimensions

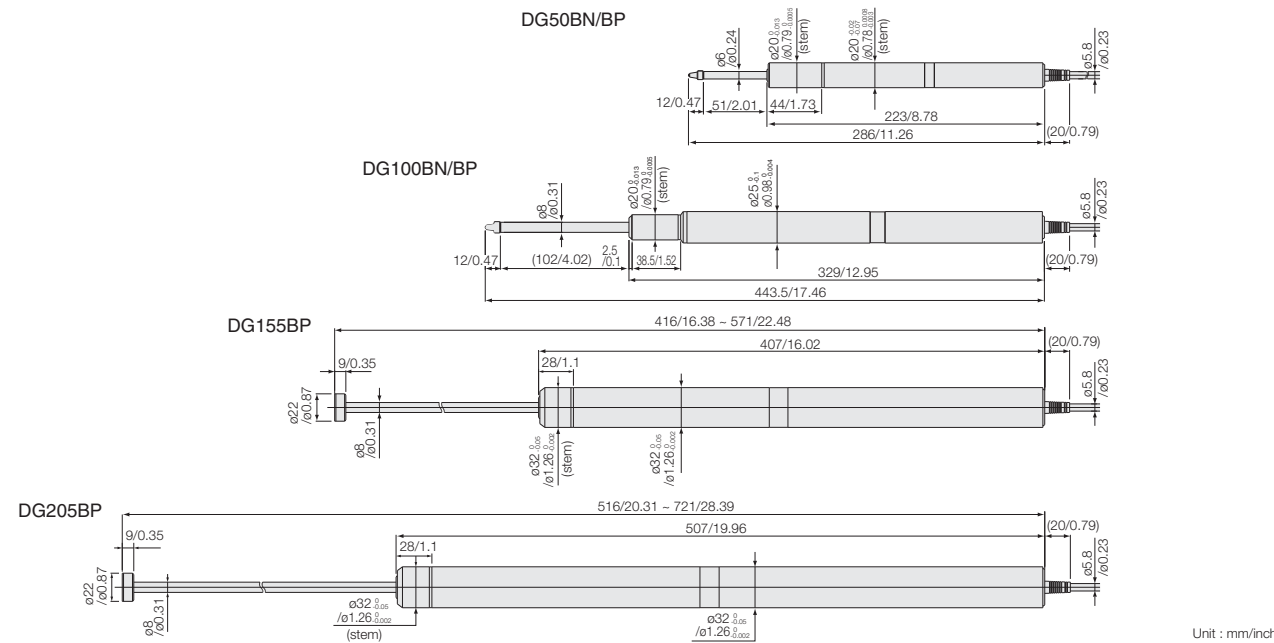

| Specifications | | | | | | |
|----------------------------|--|---------------------------------|-------------------------------------|--|--|--------------------------|
| Model | DG50BP BPM/BPE | DG50BN BNM/BNE | DG100BP BPM/BPE | DG100BN BNM/BNE | DG155BP BPM/BPE | DG205BP BPM/BPE |
| Type | For Counter, A/B quadrature signal output type (See Page 26) | | | | | |
| Measuring range | 50 mm/ 1.97" | | 100 mm/ 3.94" | | 155 mm/ 6.1" | 205 mm/ 8.07" |
| Resolution | 0.5 μm | | | | | |
| Measuring range force | Upward | All direction: 6.2 N or less | — | All direction : 9.3 N or less | 1.8 ± 0.65 N | — |
| | Lateral | | | | | |
| | Downward | | | | | |
| Accuracy (at 20°C / 68°F) | 2 μm | | 4 μm | | 5 μm | 6 μm |
| Maximum Response speed | 1m/s | | | | | |
| Operating temperature | 0 °C to 50 °C / 32 °F to 122 °F (gauge) | | | | | |
| Storage temperature | -20 °C to 60 °C / -4 °F to 140 °F | | | | | |
| Cable length | 5 m/ 16.4' | | | | | |
| Mounting stem diameter | ø 20 ^{+0.013} _{-0.005} mm/ ø 0.79 ^{+0.0005} " | | | ø 32 (0/-0.05) mm/ ø 1.26* (0/-0.002") | | |
| Feeler | carbide ball tipped feeler (DZ-122) | | carbide ball tipped feeler (DZ-121) | | | |
| Magnetic feeler | — | | — | | Attraction force: 10 N(DZ181) Lateral slippage force: 2.7 N | |
| Protective design grade | Equivalent to IP64 | | Equivalent to IP64 | | Equivalent to IP 64 | |
| Sealing (oil, water, dust) | Oil sealing, O-rings, Y-gaskets | | Oil sealing, O-rings, Y-gaskets | | Oil sealing, O-rings, Y-gaskets | |
| Mass*1 | Approx.360 g/ 0.793 lbs | | Approx.630 g/ 1.388 lbs | | Approx.1100 g/ 2.425 lbs | Approx.1300 g/ 2.866 lbs |
| Lift lever | — | | DZ-161 (option) | | DZ-161 (option) | |
| Air lifter | DZ174-010 (option) | | | | | |

DG155BP/205BP does not include the spring. *1 excl. cable unit and interpolator unit *2 Tubing for compressed air can be attached.

DG

DG110_B Series

High accuracy gauge with controllable measuring force

- High accuracy: 4 μm
- Resolution: 0.5 μm ● Measuring range: 110 mm / 4.33" ● Reduced measurement error
- Precision dual spindle support allows for a smooth spindle motion and virtually error free measurements.
- Reduced measuring force
The measuring force can be reduced to a minimum of 0.3 N in three selectable steps using the measuring balancer (option). The force is maintained constant regardless of spindle movement direction.
- Soft spindle return. A braking mechanism reduces spindle return speed, thereby eliminating the danger of damaging either the surface plate or the workpiece.

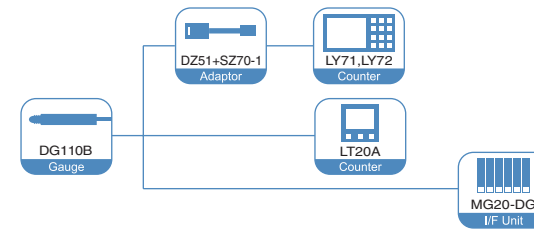

*Digital gauge stand DZ-531 and Measuring force balancer DZ-581 are option.



Digital Gauge

Dimensions

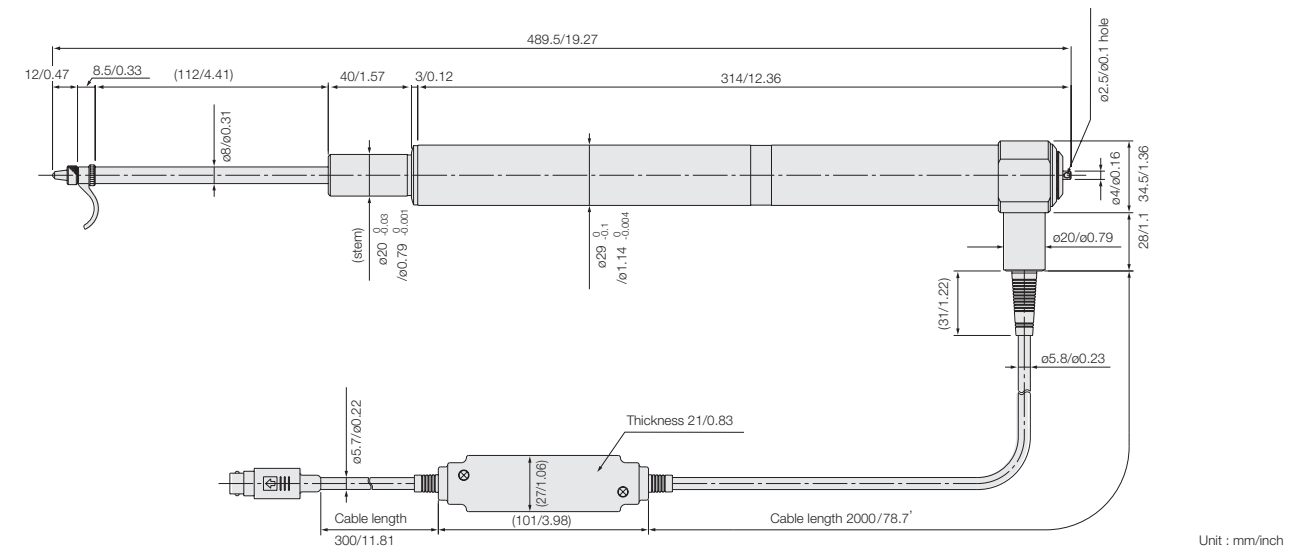

| Specifications | |
|------------------------|---|
| Model | DG110B/BM/BE |
| Type | For Counter, A/B quadrature signal output type (See Page 26) |
| Measuring range | 110 mm/ 4.33" |
| Resolution | 0.5 μm |
| Measuring range force | Downward 1.55 ± 0.15 N ² |
| Accuracy | 4 μm |
| Operating temperature | 0 °C to 50 °C / 32 °F to 122 °F |
| Storage temperature | -10 °C to 60 °C / 14 °F to 140 °F |
| Cable length | 2 m/ 6.56' |
| Mounting stem diameter | ø 20 ^{+0.013} _{-0.005} mm/ø0.78 ^{+0.0005} " |
| Feeler | Feeler tipped with ø 2.5 mm/ 0.098" dia. Carbide ball with M2.5p x 0.45 screw on fitting end (DZ-121) |
| Mass*1 | Approx.1150 g/ 2.54 lbs |
| Lift lever | DZ-161 (supplied) |

*1 excl. cable unit and interpolator unit. *2 The measurement force values given apply when DZ-581 measuring force balancer is not used. By using a measuring force balancer (option), it is possible to reduce the measuring force to minimum of 0.3 N. The measuring force will be constant regardless of spindle position.

DG-M/E Type



Outputs

| Model | Display connection type | | | | | | A/B quadrature output type | | | | | | | | | | | |
|-------|-------------------------|----|----|------------------------|---|----|----------------------------|-----|-----|------------------------|----|-----|-----|-----|-----|-----|----|-----|
| | For counter | | | Power supply output 5V | | | | | | Power supply 11 to 28V | | | | | | | | |
| | B | BN | BS | BL | F | FL | BM | BNM | BSM | BLM | FM | FLM | BE | BNE | BSE | BLE | FE | FLE |
| DG805 | | | | BL | | FL | | | | BLM | | FLM | | | | BLE | | FLE |
| DG810 | B | | | BL | F | FL | BM | | | BLM | FM | FLM | BE | | | BLE | FE | FLE |
| DG10 | BP | BN | BS | | | | BPM | BNM | BSM | | | | BPE | BNE | BSE | | | |
| DG25 | BP | BN | BS | BL | | | BPM | BNM | BSM | BLM | | | BPE | BNE | BSE | BLE | | |
| DG50 | BP | BN | | | | | BPM | BNM | | | | | BPE | BNE | | | | |
| DG100 | BP | BN | | | | | BPM | BNM | | | | | BPE | BNE | | | | |
| DG155 | BP | | | | | | BPM | | | | | | BPE | | | | | |
| DG205 | BP | | | | | | BPM | | | | | | BPE | | | | | |
| DG110 | B | | | | | | BM | | | | | | BE | | | | | |

B : Straight BP : Straight/Sealing BN : Straight/Low measuring force BS : L shape/Sealing BL : L shape/Low measuring force F : Straight/Low measuring force/Flange F : L shape/Low measuring force/Flange

Dimensions

Display connection type

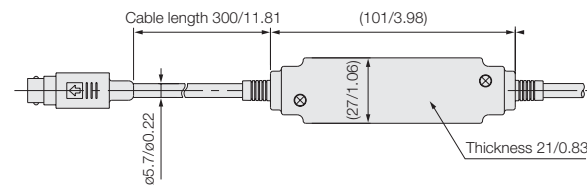

A/B quadrature output type

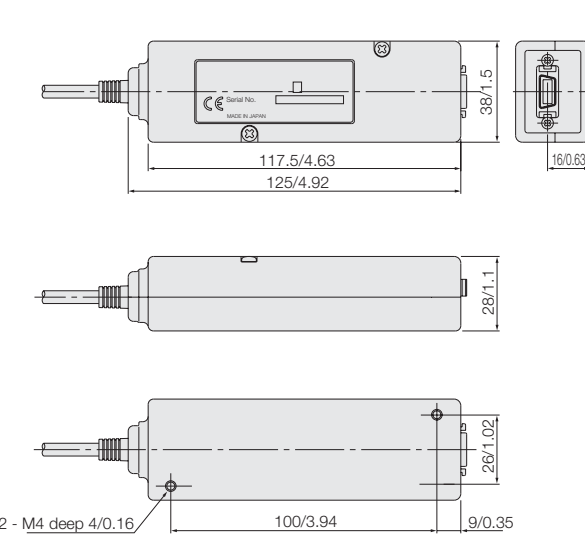

*Build to order for A/B quadrature output type.

Unit : mm/inch

A/B quadrature output type For automatic inspection/measurement in production lines.

- DG-M series for direct AB quadrature output with 5V power supply
- DG-E series for direct AB quadrature output with power supply from 11 to 28V

Specifications

| Model | DG□□□M | DG□□□E |
|-----------------------------------|--|--|
| Power supply voltage | DC 5V ± 5 % (Correspond to remote sensing function) | DC 11V to 28V (Correspond to remote sensing function) |
| Power consumption | 300 mA (Maximum) | 150 mA (Maximum) |
| Output interface | Based on EIA-422 (Line driver:AM 26C31 or equivalent) | |
| Output signal | A/B quadrature signal | |
| Resolution | 0.5, 1, 2.5, 10 μm (0.000025", 0.0005", 0.0001", 0.00025", 0.0005") selectable | |
| Maximum response speed | 1 m/s | |
| Minimum phase difference | 200 ns The output phase difference varies with the measuring speed. | |
| Alarm | A/B quadrature output of this probe turns to high impedance for 10 to 20 ms when excessive speed or cable disconnection alarm occurs. If the cause is removed, the alarm signal is automatically reset. | |
| Output connector | MDR10214-52A2JL (3M) * | |
| Dimensions | 125 x 28 x 28 (mm) (not including projecting parts) | |
| Operating temperature | 0°C to 40°C / 32°F to 104°F | |
| Storage temperature | -20°C to 60°C / -4°F to 140°F | |
| Mass (excl. cable and gauge part) | Approx. 150 g | |

*Cable MDR-10114-3000VE (3M)

Accessories (for DGB series)

DZ51 (Relay adapter) For connections of DG-B, DL-BR, DL-B and DT12/32N/P* to LG, LH and LY displays



*To connect the DT12/32N/P, use the DZ51 in combination with the MT10 detector.

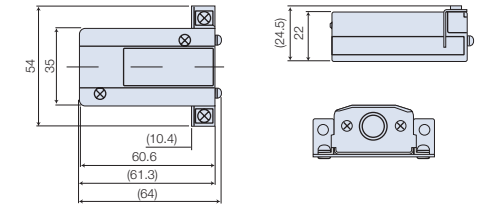

Unit : mm

DZ-501 Digital gauging stand (for DG10B to DG100B, DE-30BR)



- Surface plate material: alumina ceramic
- Surface plate flatness: 2 μm
- Surface plate size: 110 mm (4.33") x 110 mm (4.33")
- Maximum workpiece height: approx. 190 mm (7.48")
- Gauge mounting hole: ø 20mm (0.79")
- Mass: 13kg (28.67 lbs)

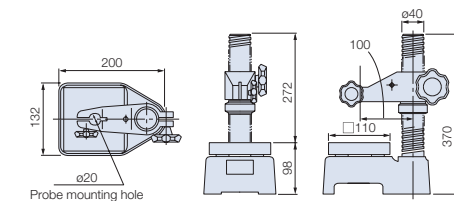

Unit : mm

DZ174-010/025/050 Air lifter (for DG10B to DG50B)

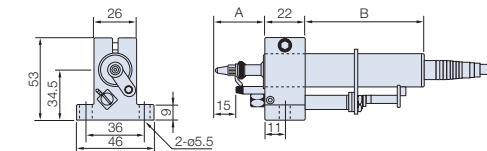
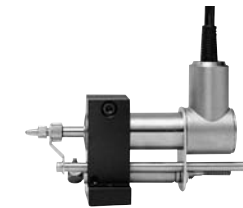

| Measuring unit | A | B | Measuring unit | A | B |
|----------------|------|------|----------------|------|------|
| DG10BP/BN | 32.5 | 75.5 | DG25BS | 47.5 | 98.5 |
| DG10BS | 32.5 | 56 | DG25BL | 47.5 | 98.5 |
| DG25BP/BN | 47.5 | 118 | DG50BP/BN | 72 | 200 |

Unit : mm

DZ-122 Feeler (for DG10B to DG50B)

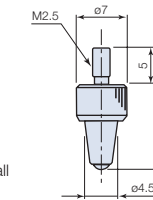

- Contact point: ø 2.5 mm/0.098" carbide ball tip (mounting screw: M2.5 x 0.45)

Unit : mm

DZ-100 Roller feeler (for DT Series, DG-B Series: except for DG155BP/205BP)

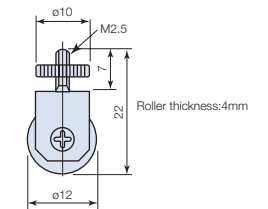

Unit : mm

DZ-181 Magnetic contact point feeler (for DG155BP/205BP)

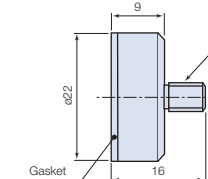

Unit : mm

DZ-191 Coupling

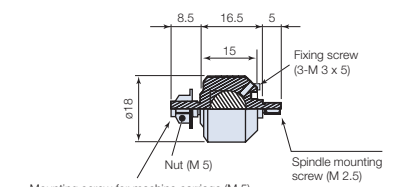

Unit : mm

DZ-801 Air lifter (for DG805BL/810BL)

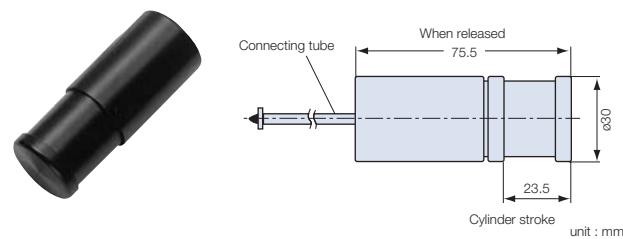

DZ-161 Lift lever (for DG-B except DG155BP/205BP; standard accessory for the DG110B)

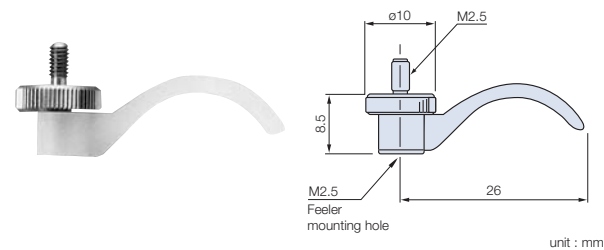

DZ-531 Digital gauging stand (for DK110, DG110B)

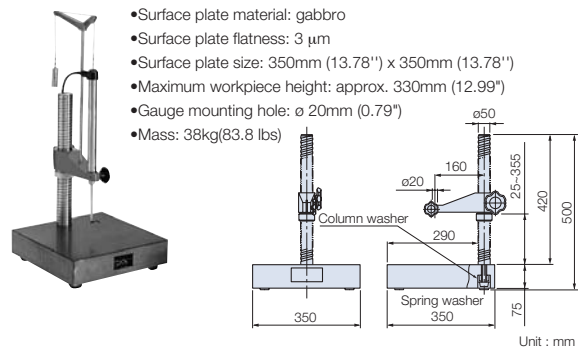

- Surface plate material: gabbro
- Surface plate flatness: 3 μ m
- Surface plate size: 350mm (13.78") x 350mm (13.78")
- Maximum workpiece height: approx. 330mm (12.99")
- Gauge mounting hole: ϕ 20mm (0.79")
- Mass: 38kg(83.8 lbs)

DZ-581 Measuring force balancer (for DK110, DG110B)

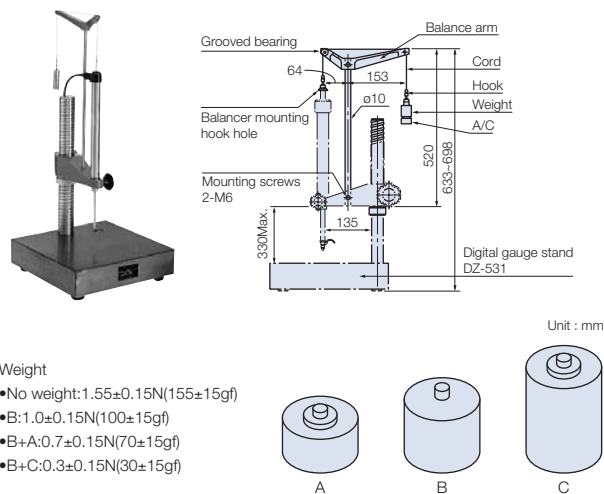

- Weight
- No weight: 1.55 \pm 0.15N(155 \pm 15gf)
 - B: 1.0 \pm 0.15N(100 \pm 15gf)
 - B+A: 0.7 \pm 0.15N(70 \pm 15gf)
 - B+C: 0.3 \pm 0.15N(30 \pm 15gf)

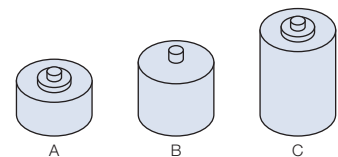

DZ-5100 Feeler set

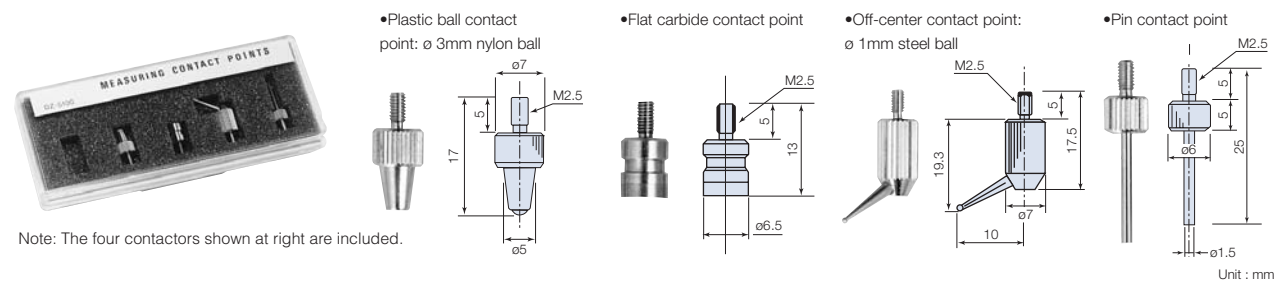

Note: The four contactors shown at right are included.

SZ70-1 Adapter

SZ70-1 is required for connecting the following scale units and counters:

Gauge unit : DE-BR Series, DG-B Series

Counter : LH71A/72, LY71 and LY72

* Adapter DZ51 is also required

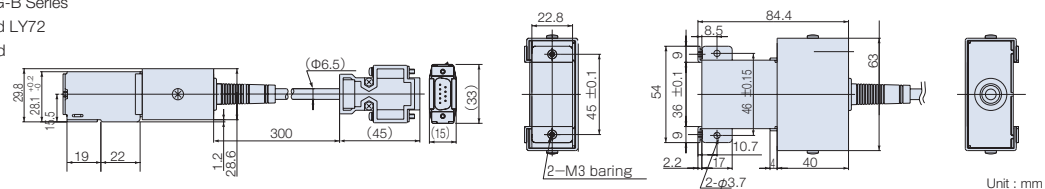

*Please refer to p54 for the details of the screw.

DT

DT512_{N/P}

Compact and slim gauges with 1 μm resolution

- Excellent resistance to workshop conditions (DT512P: IP64)
- Resistant to oil, water, dust, vibration, and shock.
- Accuracy: 6 μm
- Resolution: 1 μm
- Measuring range: 12 mm / 0.47"
- Compact size ideal for designing into machines
12 x 35 x 116 mm / 0.47" x 1.38" x 4.57" (D x W x L)

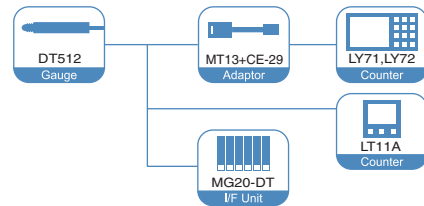

Digital Gauge

Dimensions

DT512N

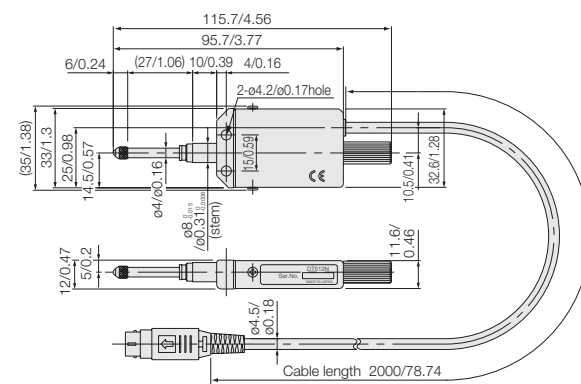

DT512P

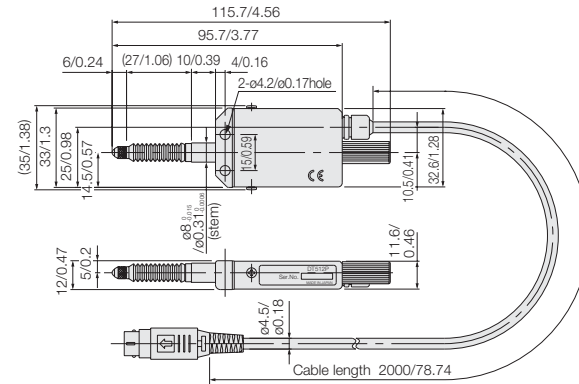

Dimensions and dimensional tolerance for the mounting holder

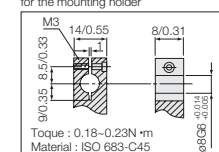

Unit : mm/inch

| Specifications | | DT512N | DT512P |
|------------------------------|----------|--|-------------------------------|
| Model | | DT512N | DT512P |
| Measuring range | | 12 mm/0.47" | |
| Resolution | | 1 μm | |
| Accuracy (at 20 °C /68 °F) | | 6 μm | |
| Measuring force | Upward | 0.7 ± 0.5 N | All directions: 1.7 N or less |
| | Lateral | 0.8 ± 0.5 N | |
| | Downward | 0.9 ± 0.5 N | |
| Protective design grade | | Equivalent to IP64 | |
| Operating temperature | | 0 °C to 50 °C /32 °F to 122 °F | |
| Storage temperature | | -10 °C to 60 °C /14 °F to 140 °F | |
| Cable length | | 2 m/6.56' | |
| Mounting stem diameter | | ø 8 ^{0.015} _{-0.0059} mm/ ø 0.31" ^{0.00059} | |
| Feeler | | Feeler tipped with 3 mm dia. steel ball with M2.5p x 0.45 screw on fitting end | |
| Mass (excl. cable unit) | | 75 g / 2.65 oz | 80 g / 2.82 oz |
| Guaranteed number of strokes | | 5 million | |

DT

DT12_{N/P}, 32_{N/NV/P/PV}

Compact and slim gauges

- Excellent resistance to workshop conditions (DT12P, DT32P/PV : IP64)
- Resistant to oil, water, dust, vibration, and shock. ● Accuracy : 10 μm
- Resolution : 5 μm ● Measuring range : 12mm/ 0.47", 32mm/1.26"
- Compact size ideal for designing into machines
DT12 : 12(D) x 35(W) x 116(H)mm/ 0.47" x 1.38" x 4.57"
DT32 : 12(D) x 35(W) x 218(H)mm/ 0.47" x 1.38" x 8.58"
- Pneumatic push type are also available ● Guaranteed number of strokes : 5million
- Main applications : Automatic sorting of parts

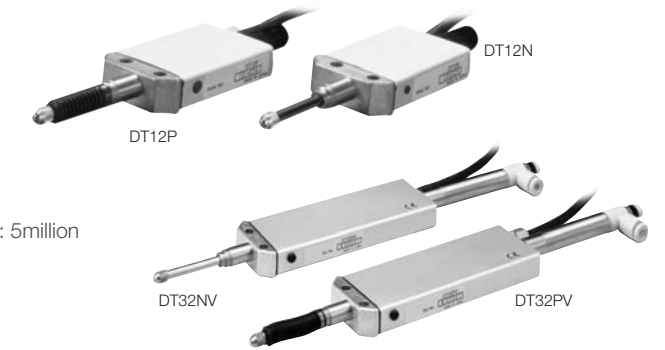
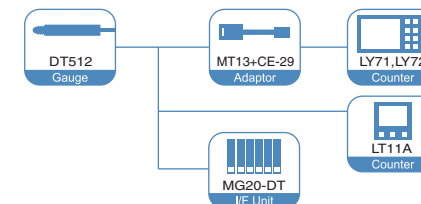

Digital Gauge

Dimensions

DT12N

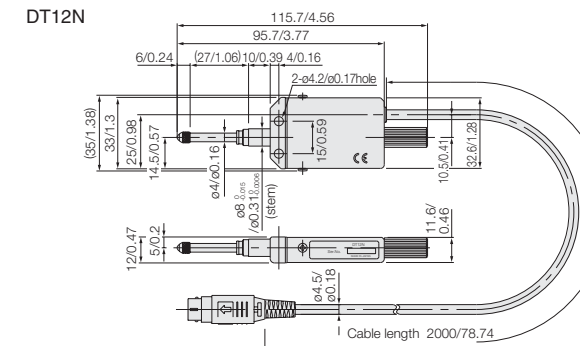

DT32N

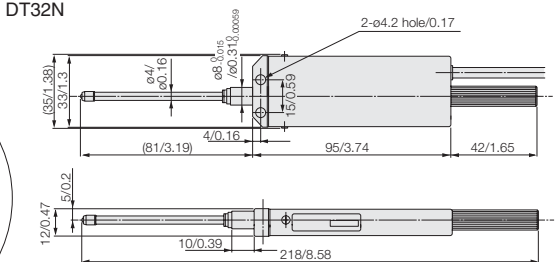

DT32PV

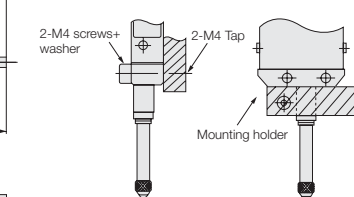
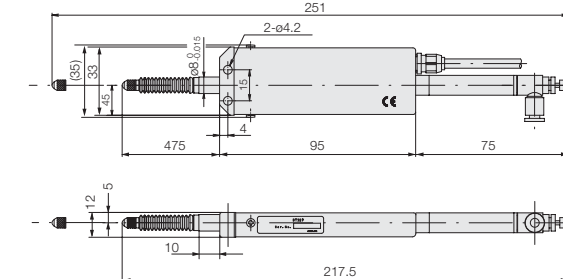

Dimensions and dimensional tolerance for the mounting holder

Torque : 0.18 to 0.23N·m
Material : ISO 683-C45

Unit : mm/inch

| Specifications | | DT12N | DT12P | DT32N | DT32NV | DT32P | DT32PV |
|------------------------------|----------|--|------------------------------|-----------------------|-----------------------|------------------------------|-------------------------------|
| Model | | DT12N | DT12P | DT32N | DT32NV | DT32P | DT32PV |
| Spindle actuation | | — | | Pneumatic push type | | Pneumatic push type | |
| Measuring range | | 12 mm/ 0.47" | | 32 mm/ 1.26" | | | |
| Resolution | | 5 μm | | 5 μm | | | |
| Measuring range force | Upward | 0.7 ± 0.5 N | All direction: 1.7 N or less | 1.1 ± 0.8 N | | All direction: 2.9 N or less | All direction: *2 9 N or less |
| | Lateral | 0.8 ± 0.5 N | | 1.3 ± 0.8 N | | | |
| | Downward | 0.9 ± 0.5 N | | 1.5 ± 0.8 N | | | |
| Accuracy (at 20 °C / 68 °F) | | 10 μm | | | | | |
| Operating temperature | | 0 °C to 50 °C / 32 °F to 122 °F (gauge) | | | | | |
| Storage temperature | | -10 °C to 60 °C / 14 °F to 140 °F | | | | | |
| Cable length | | 2 m/ 6.56" | | | | | |
| Mounting stem diameter | | ø 8 ^{0.015} _{-0.0059} mm/ ø 0.31" ^{0.00059} | | | | | |
| Feeler | | Feeler tipped with ø 3 mm/ ø 0.12" dia. Carbide ball with M2.5p x 0.45 screw on fitting end (DZ-123) | | | | | |
| Mass*1 | | Approx.75 g/ 2.65 oz | Approx.80 g/ 2.82 oz | Approx.120 g/ 4.23 oz | Approx.140 g/ 4.94 oz | Approx.120 g/ 4.23 oz | Approx.140 g/ 4.94 oz |
| Protective design grade | | — | | Equivalent to IP64 | | Equivalent to IP64 | |
| Guaranteed number of strokes | | — | | 5 million | | | |

*1 excl. cable unit and Interpolator unit.

*2 Measuring force with air pressure of 1.96 x 10⁵ Pa and speed control is open.*3 Measuring force with air pressure of 2.35 x 10⁵ Pa and speed control is open.

Accessories (for DT series)

DZ176 Air lifter (for DT)



- Measuring range: 0 to 12 mm
- Can be used for DT12/512P/N
- Air pressure: 250 to 700 kPa (25,48 to 69,58 N/cm²)
- Operating temperature: 0 to 50°C
- Storage temperature: -10 to 60°C
- Mass: 41g (incl. speed controller)
- Service life: 5 million times
- Supplied accessories: Mounting jig, speed controller (SMC: AS1211F-M5-04)

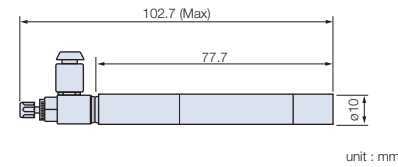

unit : mm

DZ-191 Coupling

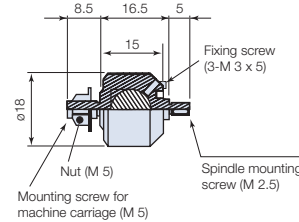

Unit : mm

DZ-100 Roller feeler (for DT Series, DG-B Series: except for DG155BP/205BP)

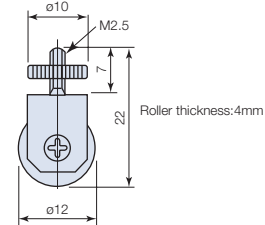

Unit : mm

Other accessories

- CE-08 Extension cable : CE08-01 (1m) , 03 (3m) , 05 (5m) , 10 (10m) , 15 (15m)
- CK-T Extension cable (Ahead-proof) : CK-T12 (1m) , T13 (3m) , T14 (5m) , T15 (10m)
- CK-T101/T105 (Winding-proof) : T101 (3m) , T105 (5m) S

MT

MT12/13/14

Detectors for DT12 / 32 Series

- MT12/13: For connection to counter
- MT14: Unterminated cable
- A/B-quadrature output by line driver [EIA-422 compliance]
- Power supply + 5 V DC

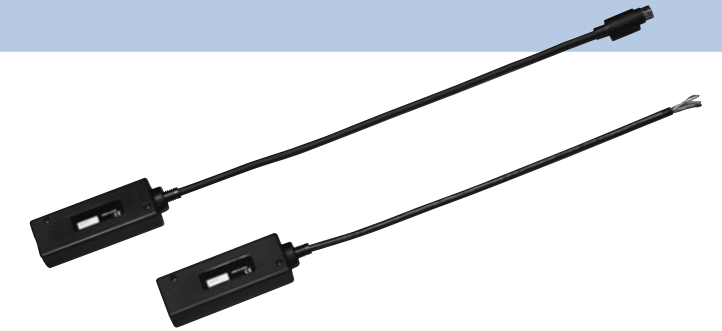
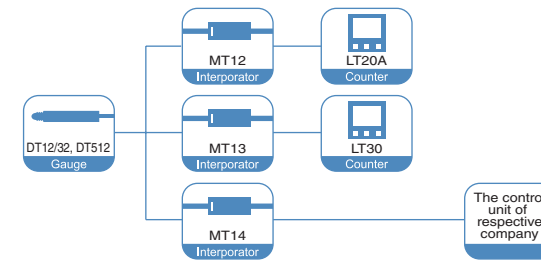

Interpolator

Dimensions

MT12 / MT13

Measuring unit connector

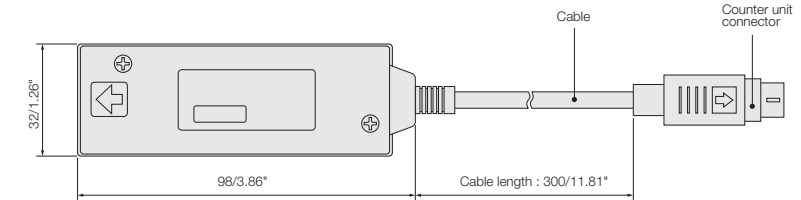
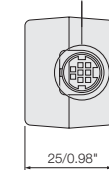

MT14

Measuring unit connector

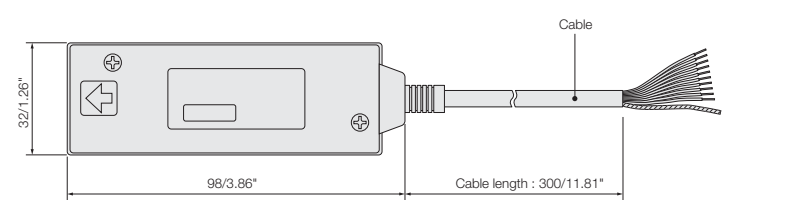
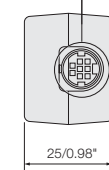

Unit : mm/inch

Phase difference for A/B phase output

| Model | MT□□-01 | MT□□-05 | MT□□-10 | Output phase difference (μs) |
|------------------|-----------|-----------|-----------|------------------------------|
| Velocity (m/min) | 0 to 2.5 | 0 to 12.5 | 0 to 25 | 20 |
| | to 6.25 | to 31.25 | to 62.5 | 8 |
| | to 12 | to 60 | to (100)* | 5 |
| | to 24 | to (100)* | - | 2.5 |
| | to 60 | - | - | 1 |
| | to (100)* | - | - | 0.5 |

* An alarm is output at a traveling velocity of 100 to 115 m/min. The sampling frequency of the output signal is 120 μs.

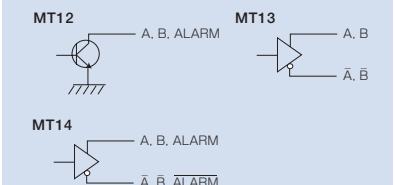

| Pin no. | Description | Cable color |
|---------|-------------|-------------|
| 1 | +5 V | Red |
| 2 | - | - |
| 3 | 0 V | Black |
| 4 | A | Yellow |
| 5 | B | Blue |
| 6 | - | - |
| 7 | - | - |
| 8 | ALARM | Gray |
| 9 | 0 V | Purple |
| 10 | 0 V | Orange |
| Case | FG | Shield |

| Pin no. | Description | Cable color |
|---------|-------------|-------------|
| 1 | +4.5 V | Purple |
| 2 | 0 V | Black |
| 3 | A | Blue |
| 4 | Ā | Yellow |
| 5 | B | Orange |
| 6 | B̄ | Gray |
| 7 | - | - |
| 8 | - | - |
| Case | FG | Shield |

| Description | Cable color |
|-------------|-------------|
| +5 V | Red |
| 0 V | White |
| 0 V | Brown |
| 0 V | Black |
| A | Yellow |
| Ā | Blue |
| B | Gray |
| B̄ | Orange |
| ALARM | Purple |
| ALARM | Green |
| FG | Shield |

Connector used: Hosiden TCP8938 or equivalent product
0V and the shield (FG) are connected with a capacitor.
Nothing should be connected to cables with colors not found in this table.

Connector used: Hosiden TCP8938 or equivalent product
0V and the shield (FG) are connected with a capacitor.
Nothing should be connected to cables with colors not found in this table.

0V and the shield (FG) are connected with a capacitor.

Specifications

| Model | MT12-05/10 | MT13-01/05/10 | MT14-01/05/10 |
|--|-------------------------------|---|---------------|
| Compatible measuring units | DT12/32, DT512 | | |
| Maximum response speed | 100 m/min | | |
| Resolution | 5μm(-05), 10μm(-10) | 1μm(-01), 5μm(-05), 10μm(-10) | |
| Power voltage | DC5 V ±4 % | | |
| Power consumption | 0.9 W | 1.2 W (when output load of 120Ω is connected) | |
| Output format | NPN open collector | Voltage differential line driver | |
| Operating temperature and humidity range | 0 to +50 °C (no condensation) | | |
| Storage temperature and humidity range | -10 to +60 °C (20 to 90 %RH) | | |
| Dimensions | See the Dimensional Diagram. | | |
| Mass | About 90 g | | |

*Please refer to p54 for the details of the screw.

DL

DL-B

Slim, compact gauges

- Magnetic principle
- Excellent resistance to workshop conditions (DL310B: IP64). Resistant to dust and vibrations.
- Compact size ideal for designing into machines.
- A/B phase output by open collector
- Measuring range: 10 mm / 0.39" and 30 mm / 1.18"

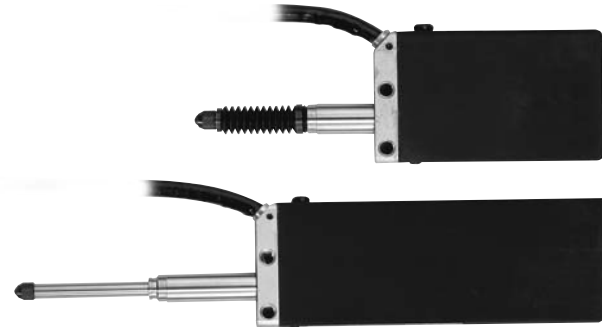
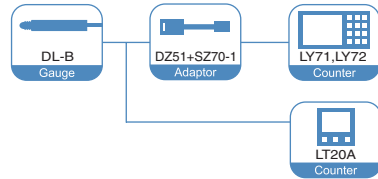

Digital Gauge

Dimensions

DL310B

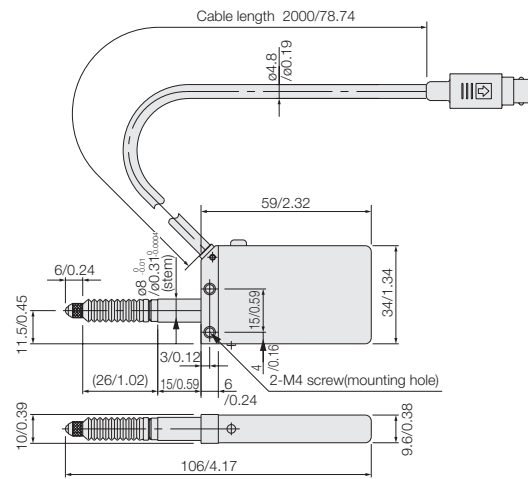

DL330B

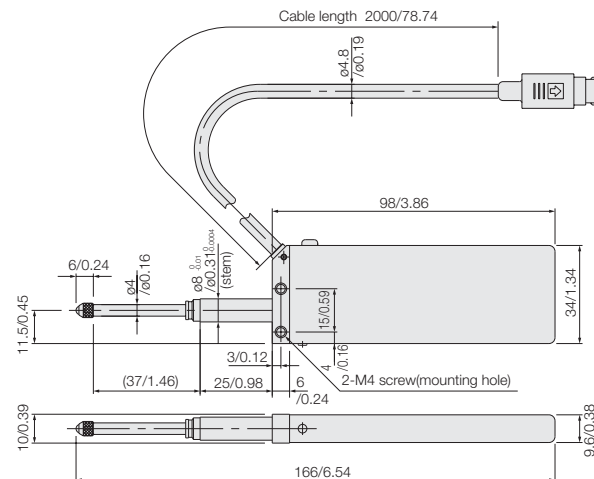

Unit : mm/inch

Specifications

| Model | DL310B | DL330B |
|--------------------------------|---|----------------|
| Measuring range | 10 mm/ 0.39" | 30 mm/ 1.18" |
| Resolution | 10 μm | 10 μm |
| Accuracy (at 20 °C / 68 °F) | 10 μm | 10 μm |
| Measuring force | 1.5 N or less | 1.5 N or less |
| Output signal | A/B phase by NPN open collector (12 VDC, 10 mA or less) | |
| Maximum response speed*1 | 120 m/ min | |
| Protective design grade | Equivalent to IP 64 | |
| Mounting stem diameter | ø 8 ^{+0.01} mm / ø 0.31 ^{+0.0004} " | |
| Operating temperature | 0 °C to 50 °C / 32 °F to 122 °F | |
| Storage temperature | -10 °C to 60 °C / 14 °F to 140 °F | |
| Power supply | 5 VDC ± 5% | |
| Power consumption | 0.2 W | |
| Cable length | 2 m / 6.56 ⁺² | |
| Feeler | Feeler tipped with 3 mm dia. carbide ball with M2.5 x 0.45 screw on fitting end (DZ123) | |
| Mass (excl. cable unit) | 60 g / 2.12 oz | 90 g / 3.17 oz |
| Vacuum pressure for Air lifter | 6.0 x 10 ⁴ to 7.5 x 10 ⁴ Pa | — |

*1: Max. response speed of the electrical circuit.

*2: Please consult our sales for more than 2m.

*Consult us when using DL310B/ 330B with the probe facing upward.

Accessories

DZ51 (Relay adapter) For connections of DG-B, DL-BR, DL-B and DT12/32N/P* to LG, LH and LY displays



*To connect the DT12/32N/P, use the DZ51 in combination with the MT10 detector.

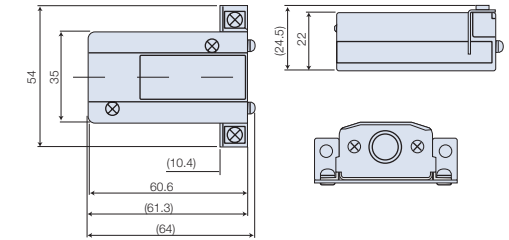

Unit : mm

DZ-811 Bushing (for mounting a U60A or a DE30BR to a DZ-501 stand)

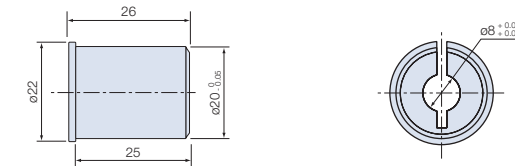

Unit : mm

DZ173 Air release (for DE12BR/30BR, U Series)

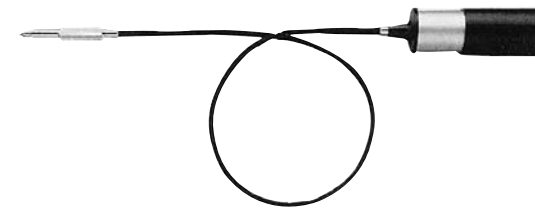

DZ175-010 Air Lifter (for DL10BR) -030 (for DL30BR) -060 (for DL60BR)

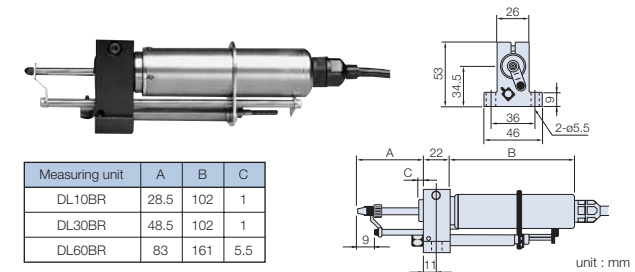

Unit : mm

DZ301 Bellows set (for DL330B, DE30BR)

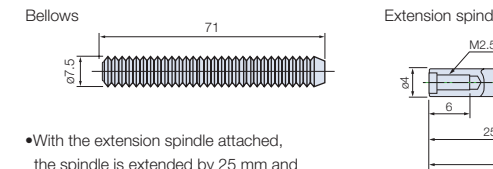

•With the extension spindle attached, the spindle is extended by 25 mm and the measuring force increases by about 0.3 N.

Unit : mm

DZ-191 Coupling

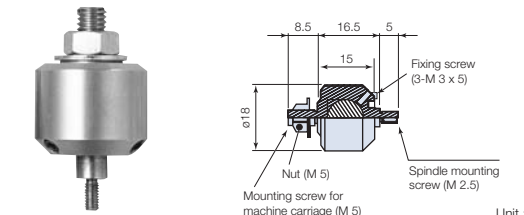

Unit : mm

SZ70-1 Adapter

SZ70-1 is required for connecting the following scale units and counters:

Gauge unit: DE-BR Series, DG-B Series

Counter: LY71 and LY72

* Adapter DZ51 is also required

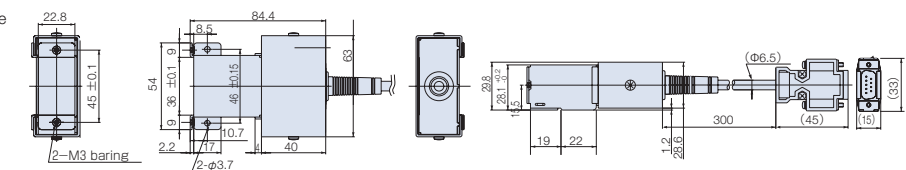

Unit : mm

*Please refer to p54 for the details of the screw.

U

U Series

Easy to operate, high-accuracy digital indicator available in a wide measuring range.

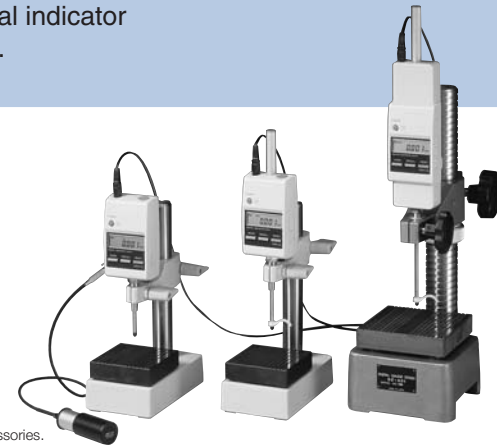

Digital Indicators

- High accuracy: 2 μm (U12B/ 30B)
3 μm (U60B)
- High resolution: 1 μm
- Measuring range: 0 to 60 mm / 0 to 2.36"
- Connectable to a personal computer through RS-232C interface.
- Peak hold for measuring max./ min./ peak-to-peak values
- The spindle contains a damper mechanism to protect measured objects from damage (U30B/ U60B).
- Inch/ metric display

*The air release and the gauging stand are optional accessories.
*Set bushing DZ-811 is required to use U60B with gauging stand DZ-501.

Dimensions

U12B

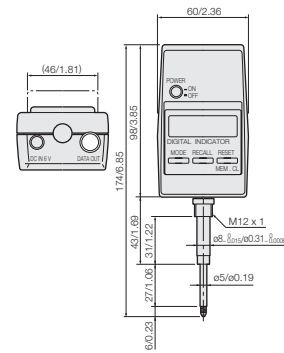

U30B

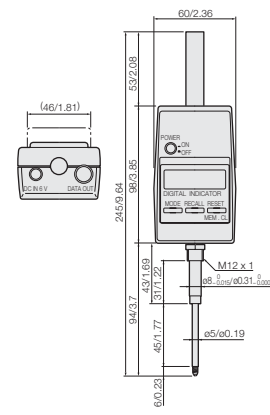

U60B

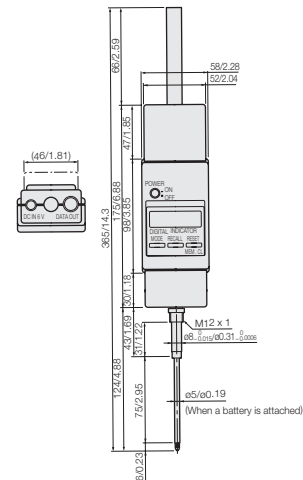

Unit : mm/inch

Specifications

| Model | U12B | U30B | U60B |
|--------------------------------|--|------------------------|-------------------------|
| Display | 6-digit LCD display, mode indication (leading zero suppress, floating minus sign) | | |
| Measuring range | 12 mm / 0.47" | 30 mm / 1.18" | 60 mm / 2.36" |
| Resolution | 1 μm | | 3 μm |
| Accuracy (at 20 °C / 68 °F) | 2 μm | | |
| Reset | By key operation | | |
| Direction | Selectable | | |
| Peak hold function | Max./ min./ peak-to-peak values | | |
| Measuring force | 1.3 N or less | 1.5 N or less | 2.2 N or less |
| Travel length of the release*1 | Full stroke | Full stroke | 32mm |
| Maximum response speed | 24 m / min | | |
| Output signal | RS-232C (2400 bps) | | |
| Mounting stem diameter | ø 8.0 ^{+0.015} mm / ø 0.31 ^{+0.0006} " | | |
| Operating temperature/humidity | 0 °C to 40 °C / 32 °F to 104 °F (non condensing) | | |
| Storage temperature/humidity | -10 °C to 50 °C / 14 °F to 122 °F (non condensing) | | |
| Power supply | AC adaptor: AC 100V 50/60Hz | | |
| Feeler | Feeler tipped with 3 mm dia. carbide ball with M2.5p x 0.45 screw on fitting end (DZ123) | | |
| Supplied accessories | lift lever wrench | | |
| Mass | Approx.190 g / 6.7 oz | Approx.230 g / 8.11 oz | Approx.300 g / 10.58 oz |

*1 When air release DZ-173 (optional accessory) is activated

Accessories (for U series)

DZ521 Gauging stand (for DG805BL/810B/810BL, U Series, DE12BR)



- Surface plate material: alumina ceramic (dark brown)
- Surface plate flatness: 2 μm
- Surface plate size: 80 mm (3.15") x 80 mm (3.15")
- Maximum workpiece height: approx. 105 mm (4.13")
- Gauge mounting hole: ø 8 mm (0.31")
- Mass: 3.8 kg (8.38 lbs)

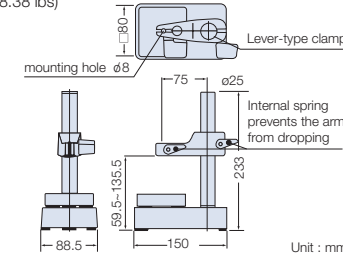

DZ173 Air release (for DE12BR/30BR, U Series)

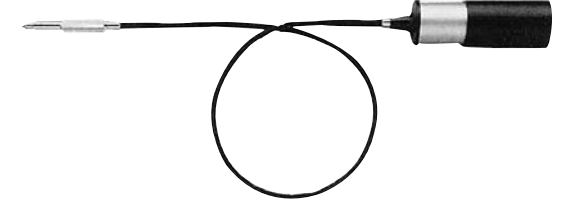

DZ-5100 Feeler set



- Plastic ball contact point: ø 3mm nylon ball

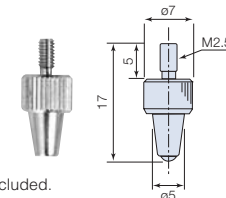

- Flat carbide contact point

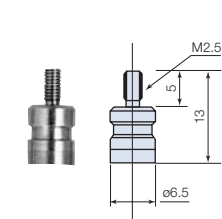

- Off-center contact point: ø 1mm steel ball

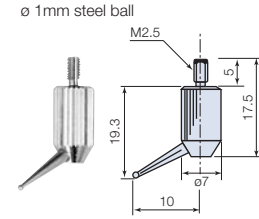

- Pin contact point

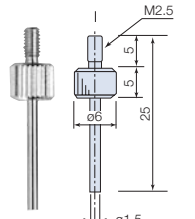

Unit : mm

Note: The four contactors shown at right are included.

Other accessories

- Cable connectors for computer connection (for U Series/ LT Series/ LY Series) DZ252 (round 8 pin ↔ D sub 9 pin) (2 m) DZ253A (round 8 pin ↔ D sub 25 pin) (2 m) DZ254 (round 8 pin ↔ unterminated end)
- Extension cable (for DZ252N/P, DZ253N/P, DZ254N/P) : CE08-1(1m), CE08-3(3m), CE08-5(5m), CE08-10(10m), CE08-15(15m)

*Please refer to p54 for the details of the screw.

Interface unit

| | |
|-------------------|----|
| MG40 Series | 40 |
| MG10/20/30 Series | 42 |

- Up to 100 connectable gauges
- High speed data communication 100Mbit/sec
- Compatible with Ethernet, cc-Link
- Operating voltage : 12-24VDC
- DIN rail mounting (35mm)



System structure

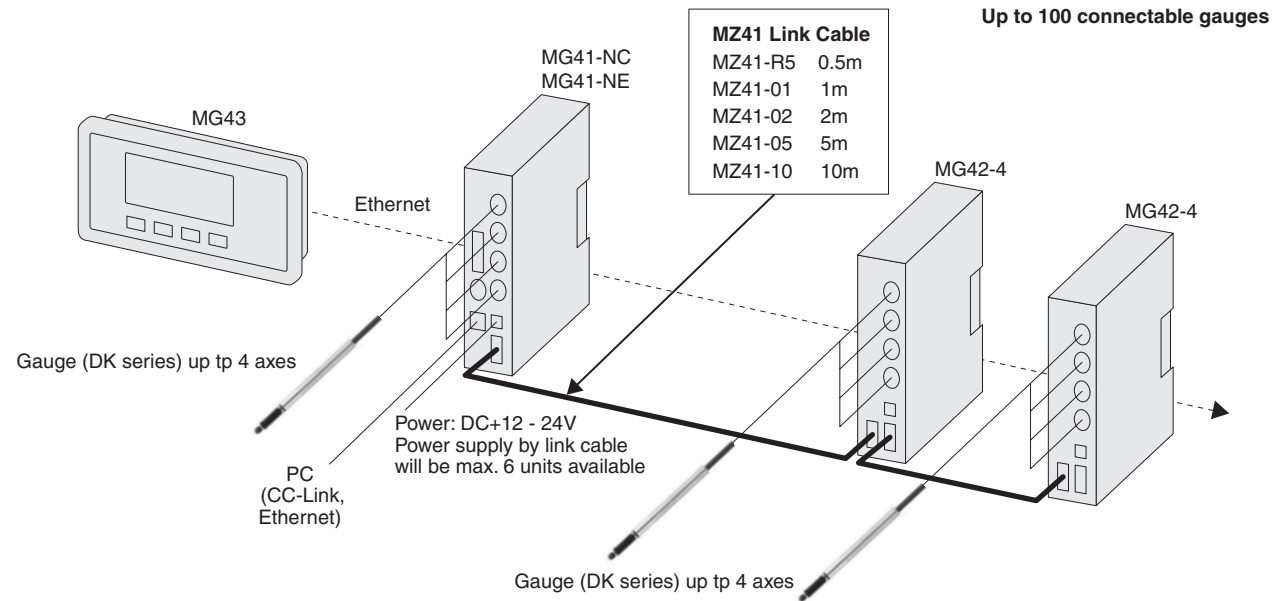

MG series System structures

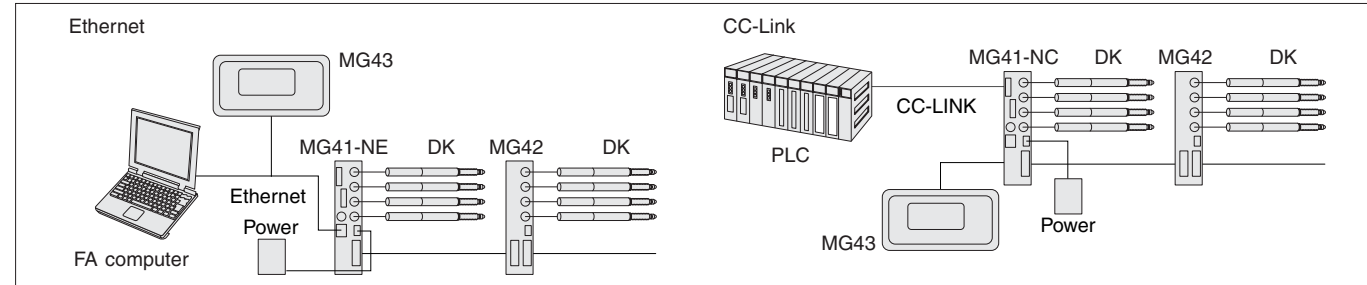

| Spec. | Model | DK802A/B | DK805A/B | DK812A/B | DK10 | DK25 | DK50 | DK100 | DK110 | DK155 | DK205 | |
|-----------------|-------|----------|----------|----------|-------|------|------|-------|-------|-------|-------|--|
| Min.resolution | | 0.1μm | | | 0.5μm | | | 0.5μm | | | | |
| Accuracy | | 1μm | | | 2μm | | | 4μm | | | | |
| Measuring Range | | 2mm | 5mm | 12mm | 10mm | 25mm | 50mm | 100mm | 110mm | 155mm | 205mm | |

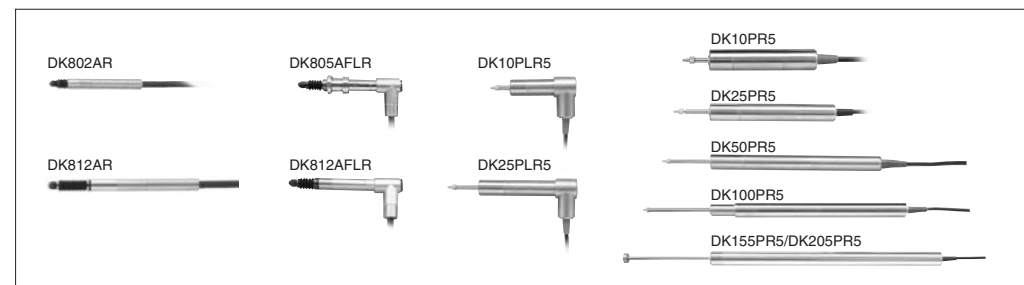

MG40

| Specifications | | Description | | Remarks | |
|---|--|---|--------------------------------------|---|--|
| Item | Conditions | | | | |
| No. of connectable measuring units | Entire system | 1 to 100 units (Connection disabled after connection of 101st unit.) | | Up to 24 connected MG42 hub units | |
| | MG41 main unit | 0 to 4 axis | | | |
| | MG42 hub unit | | | | |
| Connectable measuring units | | DK800A/DK 800B series, DK10, DK25, DK50, DK100, DK110, DK155, DK205 | | | |
| Connection cable length | | Between MG41 main unit and MG42 hub unit, between MG42 hub unit and MG42 hub unit: 0.5 m, 1 m, 2 m, 5 m, 10 m | | | |
| | | Total cable length from MG41 main unit: Maximum 30 m (Maximum current: 4 A or less) | | | |
| Resolution | | Settable output data resolution and display resolution | | | |
| | Measuring unit resolution (input resolution) | 0.1μm 0.5μm | 0.1μm 0.5μm 1μm 5μm 10μm | | |
| Measuring unit data import capacity | 10 Mbps data transfer | Maximum 10,000 data/s (when 100 axes are connected) | | The data for one axis is counted as one data. | |
| Peak-hold function | | Calculation of maximum value, minimum value, and peak-to-peak value for each axis (including pause, latch, and start functions) | | | |
| | | Peak value is not updated during pause. | | | |
| | | Output and display data are not updated during latching (internal data is updated) | | | |
| Output data | Single axis | Current value, maximum value, minimum value, and peak-to-peak value for each axis | | Single axis calculation of an addition/subtraction axis is not possible (or preventing inconsistencies in calculation). | |
| | Addition and subtraction | Current value, maximum value, minimum value, and peak-to-peak value for the two-axis addition/subtraction axis | | | |
| Comparator function | | Data for each axis (single axis, addition/subtraction axis) is compared and measured, and the comparator results are output. (Comparator during latch is also latched.) | | | |
| Comparator setting values | No. of setting value groups | 2 values | 4 values | 8 values | 16 values |
| | | 16 groups | 8 groups | 4 groups | 2 groups |
| Ethernet | | 100Base-T (compliant with IEEE 802.3) 100 Mbps/10 Mbps (Auto-negotiation) | | | |
| Reset function | | Current value for each axis is reset (by command). | | | |
| Preset function | | Value is preset to the current value of each axis (by command). | | | |
| Datum point setting function | | Datum point of each axis can be set (by command). | | | |
| Reference point function | | Reference point can be used to relocate the datum point of each axis (by command). | | When master calibration function is not used | |
| Master calibration function | | Reference point can be used to perform master calibration for each axis (by command). | | Addition/subtraction axis cannot be used. | |
| Measuring unit product information | | The product information of the connected measuring unit can be acquired. | | | |
| Command/setting enabled or disabled for each communication line | Command | Reset function | Ethernet | Available | When master calibration function is not used |
| | | Preset function | Ethernet | Available | |
| | | Datum point setting function | Ethernet | Available | |
| Data output | Current value/Peak value (All axes) | Ethernet | Available | N/A | Available |
| | Current value/Peak value (each unit) | Ethernet | Available | N/A | |
| | Comparator result | Ethernet | Available | N/A | |
| Settings | Alarm (Communication/Measuring unit) | Ethernet | Available | N/A | Available |
| | Soft ware version | Ethernet | Available | N/A | |
| | Measuring unit product information | Ethernet | Available | N/A | |
| Supply voltage | Terminal input | DC 12 to 24 V (11 to 26.4 V) | | Use a power supply with a current that is 4 A or higher. (Recommended: +24 V) (for every six MG42 hub units) | |
| Power consumption | Note the connection conditions. | System total: Max. current 4 A | | | |
| Operating temperature and humidity range | | When the maximum current is exceeded, the connection can be enabled by providing a power supply to the MG42 hub units that come later in the connection. | | | |
| Storage temperature and humidity range | | <Details of power consumption for each unit> MG41 main unit : 4 W , MG42 hub unit : 1 W/unit , Measuring unit supply : 1 W/unit | | | |
| Mass | | 0 to +50 °C (no condensation) | | | |
| | | -10 to +60 °C (20 to 90 % RH) | | | |
| | | MG41 : 300 g , MG42 : 250 g | | | |

Display unit MG43

| Specifications | | Description | |
|----------------------------|---|--|---|
| Item | Description | Item | Description |
| Compatible main units | MG41-NE/MG41-NC | Network interface | 100Base-TX / 10Base-T (compliant with IEEE802.3) Auto-negotiation |
| Compatible hub units | Hub units compatible with the main unit | Power consumption | DC12~24V(11~26.4V) |
| Compatible measuring units | Measuring units compatible with the main unit or hub unit | Power supply | 4W |
| Main functions | Measure Monitor, Setting Monitor, System Monitor | Operating temperature range | 0 to +40°C (no condensation) |
| Communication protocol | MG40 original protocol on TCP/IP | Storage temperature and humidity range | -10~+60°C (20~90%RH) |
| Screen display | 480 x 272 pixels, 4.3-inch TFT LCD with backlight | Mass | Approx.500g |

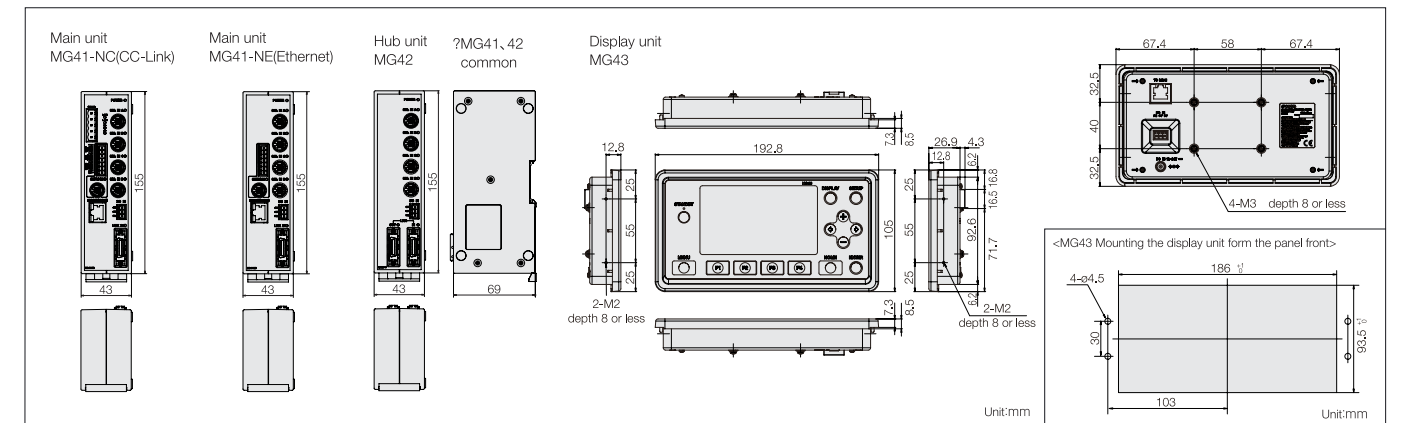

MG

MG10/20/30 SERIES

Flexible digital gauge system for multi-point measuring .

- Up to 64 connectable gauges
- Input resolutions : 0.1μm, 0.5μm, 1μm, 5μm, and 10μm.
- Compatible with RS-232C, BCD
- Operating voltage : 12-24VDC
- DIN rail mounting (35mm)



Interface unit

System structure

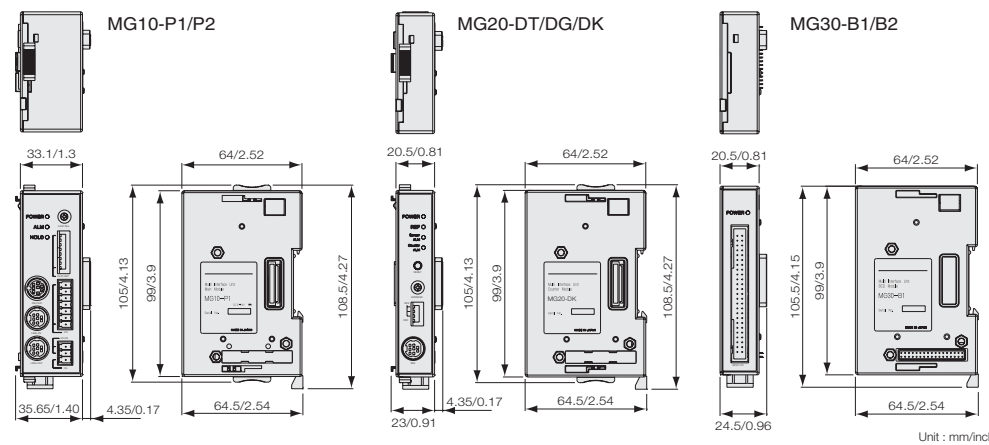

"MG" Multi Interface unit operates with a variety of modules.

- Counter module (MG20)
 - Digital gauge input
 - Resolution setting
- I/F module (MG30)
 - BCD / GO / NO GO output
 - Expansion module (Sequential lineup)
 - Connection with Counter module, I/F module

Main module (MG10)

- Power supply
- RS-232C Connection
- Connection with Counter module, I/F module

MG10-P1 : sink type output (-com)
 MG10-P2 : source type output (+com)

MG20-DK : DK series gauges
 MG20-DG : DG**B and DL**B/BR series gauges
 MG20-DT : DT series gauges

MG30-B1 : BCD sink type output (-com)
 MG30-B2 : BCD source type output (+com)

MG series System structures

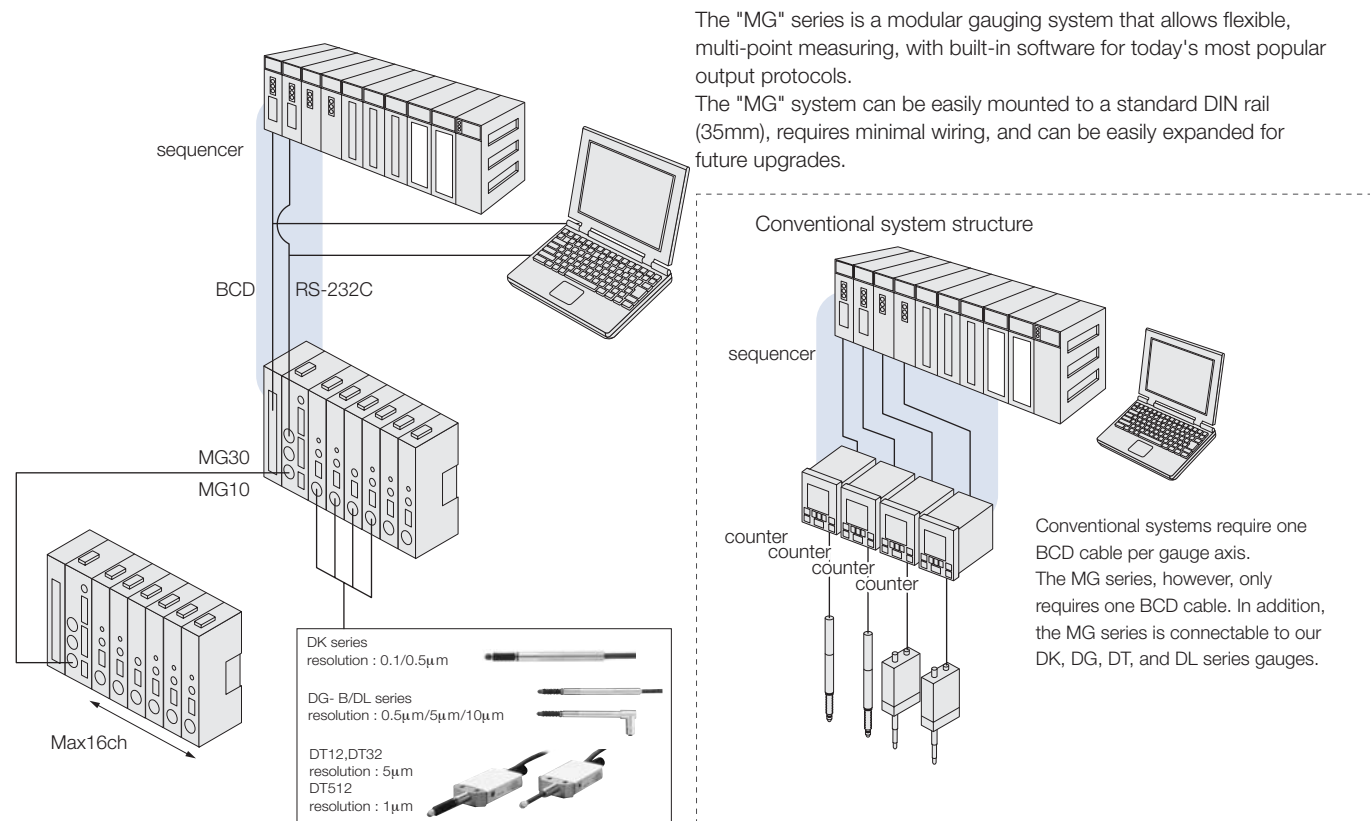

Main module

| Model name | MG10-P1 | MG10-P2 |
|---------------------|---------------------------------|---|
| Power source | Supply voltage | DC12-24V(11-26.4V)Min. startup time: 100ms or less |
| | Power consumption | 2.0W + total power consumption for connected modules ^{*1} |
| | Inrush current (10ms) | 10A or less (when maximum number of modules are connected) |
| | Power supply protection | Fuse (5A fuse is built in.) |
| Communication | Communication I/F | RS-232C (EIA-232C or equivalent) |
| | Baud rate setting | 2400 / 9600 / 19200 / 38400 bps (set with DIP switch) |
| | Data length | 7 / 8 bit (set with DIP switch) |
| | Stop bit | 1 / 2 bit (set with DIP switch) |
| | Parity | none / ODD / EVEN (set with DIP switch) |
| | Delimiter | CR / CR+LF (set with DIP switch) |
| Linkage function | Maximum number of linkages | 16 (total of counter modules: 64) |
| | Maximum length of linking cable | 10m |
| I / O | Input format | source input (+COM) / sink input (-COM) |
| | Output format | Photo coupler insulation, external power: DC5 - 24V / sink type (-COM) / source type (+COM) |
| | Input signal | Photo coupler insulation, external power: DC5 - 24V / reset, pause, start, latching, and data out trigger to whole channels |
| | Output signal | integrated alarm |
| Connectable modules | Counter modules | MG20-DK, MG20-DG and MG-20DT (available for mixed use, up to 16 modules) ^{*1} |
| | Interface modules | MG30-B1, MG30-B2 |

*1: Total power of modules connected to MG10 should not be over 54W (12VDC Input) or 108 W (24VDC Input).

Counter module

| Model name | MG20-DK | MG20-DG | MG20-DT | |
|----------------------|--|---|-----------------------------------|--|
| Power consumption | 1W + power consumption for connected gauge | 1.4W (connected to DG-B) / 0.5W (connected to DL-B) | 0.8W | |
| | Corresponding gauge | DK series (A/B quadrature input) | DG**B series, DL**B/DL**BR series | DT series |
| Measuring unit input | Allowable resolution setting ^{*2} | 10 / 5 / 1 / 0.5 / 0.1μm | 10 / 5 / 0.5μm | 5μm (DT12/32) 1μm (DT512) |
| | Maximum response speed | Subject to the specification of the connected gauge | | |
| | Reference point ^{*3} | REF-LED (reference point loaded) shows on the display after the reference point is detected. Set "0" or preset value on the counter when the reference point is detected. | | - |
| Others | Alarm | S-ALM LED activates by excess speed/acceleration of measuring unit. C-ALM LED activates by excess speed of the internal circuit of counter. | | Alarm display is cancelled by reset command from MG10 or with the reset button of main unit. |

*2: Set the resolution value of the connected gauge. *3: MG20-DG work only connect to DL**BR series

Interface module

| Model name | MG30-B1 | MG30-B2 |
|-------------------|--|---|
| Power consumption | source input (+com) | 1w |
| | sink input (-com) | |
| I/O | Input format | Photo coupler insulation, external power: DC5 - 24V |
| | Output format | Photo coupler insulation, external power: DC5 - 24V / sink type (-com) / source type (+com) |
| | Input signal | DRQ / channel address / measuring mode shifting / comparator shifting / reset / start / posing / reference point loaded |
| | Output signal | BCD data (6 digits) / READY / code / GO/NO GO output / alarm / reference point loaded |
| Output setting | timer (1-128ms) / OUT / OR / polarity (set with internal DIP switch) | |
| All models | Operating temperature | 0-+50°C (No condensation) |
| | Storage temperature | -10-+60°C (20-90%RH) |

Counter unit

| | |
|--------------|----|
| LT30 SERIES | 46 |
| LT20A SERIES | 47 |
| LT11A SERIES | 48 |
| LT10A SERIES | 49 |
| LY71 | 50 |
| LY72 | 51 |

LT

LT30 SERIES (for DK series)

Counter compatible with our compact, high-precision DK series of digital gauges.



Counter unit

- Maxmum display resolution : 0.1μm
- Zero point detection
- BCD and RS-232C I/O models are available.
- Compact and lightweight: DIN standardsize (W 72mm x H 72mm)
- Comparator ● Reset/Preset
- Alarm for exceeded max. response speed and disconnected measuring unit
- Setting value storage
- 2-axis ADD/SUB (2-axis model only)

System structure

System Configuration

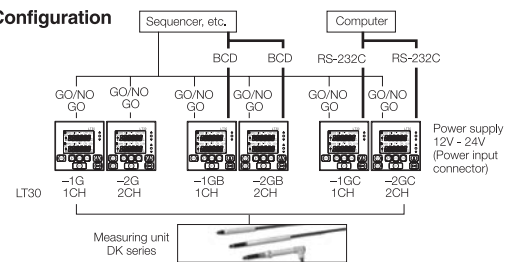

Dimensions(LT30-2GB)

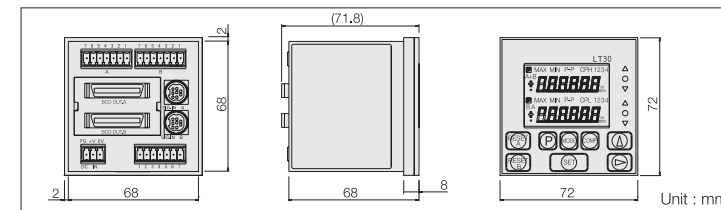

Part Names

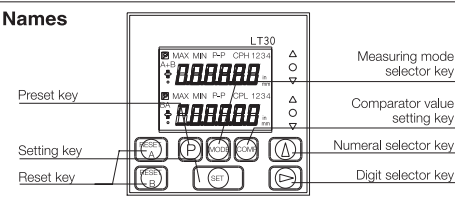

Input/output Pins

- I/O connector
Inputs : Reset, Peak hold start, Peak hold pause
Outputs : GO/NO GO ● Power input connector : 12 to 24V DC power
- BCD (36-pin half-pitch connector)
Inputs : Comparator value selection (4 settings), Mode selection (Current value, Maximum measured value, Minimum measured value, P-P value) Outputs (Open collector) : Measured data (6 digits), Alarm output
- RS-232C (8-pin mini-DIN connector) Reset, Preset value setting/recall, Peak hold start, Peak hold pause, Comparator value setting, Mode selection and output (Current value, Maximum measured value, Minimum measured value, P-P value)
- RS-TRG Trigger inputs for RS-232C data outputs

Separate accessories (Connectable to LT30-1GC/2GC)

- RS-232C cable DZ252 : D-sub 9-pin DZ253A : D-sub 25-pin

Common Specifications

| Model | LT30-1G | 1GB | 1GC | 2G | 2GB | 2GC |
|-----------------------------------|---|---|----------------------------|---------------|---|----------------------------|
| Display | 6 digit backlit LCD, mode display | | | | | |
| I/O | Measuring unit input | 1 channel | | | 2 channel | |
| | I/O connectors *1 | ○ | | | ○ | |
| | BCD *2 | ○ | | | ○ | |
| | RS-232C *3 | ○ | | | ○ | |
| RS-TRG *4 | ○ | | | ○ | | |
| Reset function | Reset key or external input (I/O connectors) | | | | | |
| Preset function | Preset value set with preset key, recalled with reset key. | | | | | |
| Comparator function | Three-level comparator Comparator value set with keys on the front panel. Result evaluation: LED and I/O connector output (photocoupler) | | | | | |
| | — | Up to 4 values can be set for comparator (key input). Switched with BCD terminal. | Set with RS-232C command | — | Up to 4 values can be set for comparator (key input). Switched with BCD terminal. | Set with RS-232C command |
| Peak hold function | Maximum, minimum, and peak-to-peak values. Measuring started by the start input of the I/O connector; update stop by pause input. | | | | | |
| Input resolution | 0.0001 mm, 0.0005 mm, 0.001 mm, 0.005 mm, 0.01 mm selectable | | | | | |
| Display resolution | 0.0001 mm, 0.0005 mm, 0.001 mm, 0.005 mm, 0.01 mm (0.00002", 0.00005", 0.0002", 0.0005") selectable | | | | | |
| Direction | Can be switched | | | | | |
| Reference point function | Function use enabled/disabled can be selected (if use is enabled, the unit enters reference point signal input wait status at the same time as power-on). | | | | | |
| Maximum response speed | 20 MHz (A/B phase difference) | | | | | |
| Addition and subtraction function | A+B, A-B, B-A can be set with the direction setting. | | | | | |
| Alarm | Speed over or measuring unit cable disconnected (Displayed on LCD or the I/O connector's comparator outputs are all "H" (OFF)). | | | | | |
| Data storage | Resolution, direction, comparator value, preset value, modes, etc. | | | | | |
| | — | BCD sign, etc | Data signalling rate, etc. | — | BCD sign, etc | Data signalling rate, etc. |
| Temperature | Operating temperature: 0 to 40°C Storage temperature: -10 to 50°C | | | | | |
| Power consumption *5 | 5 W | 5.5 W | 5 W | 8.5 W | 9 W | 8.5 W |
| Mass | Approx. 200 g | Approx. 230 g | Approx. 220 g | Approx. 210 g | Approx. 270 g | Approx. 230 g |
| Power voltage | Power input connector (3 pins) : DC9.0 to 26.4 V. | | | | | |
| Compatible measuring unit | DK series | | | | | |

Note 1 : I/O connector
Input : Reset, peak-hold start, peak-hold pause, RS trigger (RS-232C models only)
Output : Result evaluation (photocoupler)
Note 2 : BCD (36 pin half-pitch connector)
Input : Reset, peak-hold start, comparator value selection (4 settings)
Output : five digits (open collector) One of current value/maximum value/minimum value/peak-to-peak value selected and output.
Note 3 : RS-232C (8 pin mini-DIN connector)
Reset, preset value setting/recall, peak-hold start, peak-hold pause, current value hold, software version read, comparator value setting, current value/maximum value/minimum value/peak-to-peak measuring mode selection and output, key lock and release.

Note 2 : BCD (36 pin half-pitch connector)
Input : Reset, peak-hold start, comparator value selection (4 settings)
Output : five digits (open collector) One of current value/maximum value/minimum value/peak-to-peak value selected and output.
Alarm output
Note 4 : RS-TRG pin
Trigger input for RS-232C data output
Note 5 : With measuring unit connected.

LT

LT20A SERIES (for DG, DL)

Compact, lightweight, and easy-to-mount counter



Counter unit

- Compact design : DIN standard size (72 mm x 72 mm / 2.83" x 2.83" W x H).
- Suitable for panel mounting ● Selectable display resolutions: 0.5/ 1/ 5/ 10 μm
- BCD and RS-232C I/O models are available.
- Reset/preset ● Peak hold function for measuring max./ min./ peak-to-peak values and GO/NO GO evaluation. ● ADD/ SUB function (2-axis model only)
- Data storage : resolution, counting direction, comparator reference points, preset value, mode, BCD sign (B type), communication parameters (C type)
- Inch/ metric display
- Applications: automatic sorting and measuring of parts on production lines.

Dimensions

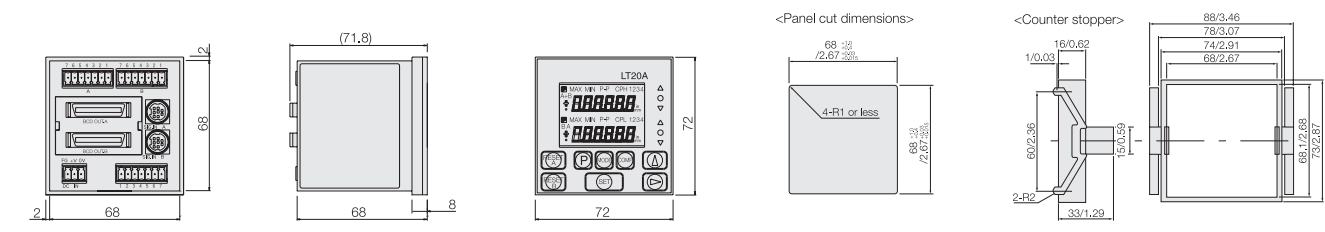

Unit : mm/inch

Common Specifications

| Model | LT20A-101 | 101B | 101C | 201 | 201B | 201C |
|-----------------------------------|---|---|----------------------------|---------------|---|----------------------------|
| Display | 6 digit backlit LCD, mode display | | | | | |
| I/O | Measuring unit input | 1 channel | | | 2 channel | |
| | I/O connectors *1 | ○ | | | ○ | |
| | BCD *2 | ○ | | | ○ | |
| | RS-232C *3 | ○ | | | ○ | |
| RS-TRG *4 | ○ | | | ○ | | |
| Reset function | Reset key or external input (I/O connectors) | | | | | |
| Preset function | Preset value set with preset key, recalled with reset key. | | | | | |
| Comparator function | Three-level comparator Comparator value set with keys on the front panel. Result evaluation: LED and I/O connector output (photocoupler) | | | | | |
| | — | Up to 4 values can be set for comparator (key input). Switched with BCD terminal. | Set with RS-232C command | — | Up to 4 values can be set for comparator (key input). Switched with BCD terminal. | Set with RS-232C command |
| Peak hold function | Maximum, minimum, and peak-to-peak values. Measuring started by the start input of the I/O connector; update stop by pause input. | | | | | |
| Input resolution | 0.0005 mm, 0.001 mm, 0.005 mm, 0.01 mm selectable | | | | | |
| Display resolution | 0.0005 mm, 0.001 mm, 0.005 mm, 0.01 mm (0.00002", 0.00005", 0.0002", 0.0005") selectable | | | | | |
| Direction | Can be switched | | | | | |
| Reference point function | Function use enabled/disabled can be selected (if use is enabled, the unit enters reference point signal input wait status at the same time as power-on). | | | | | |
| Maximum response speed | 20 MHz (A/B phase difference) | | | | | |
| Addition and subtraction function | A+B, A-B, B-A can be set with the direction setting. | | | | | |
| Alarm | Speed over or measuring unit cable disconnected (Displayed on LCD or the I/O connector's comparator outputs are all "H" (OFF)). | | | | | |
| Data storage | Resolution, direction, comparator value, preset value, modes, etc. | | | | | |
| | — | BCD sign | Data signalling rate, etc. | — | BCD sign | Data signalling rate, etc. |
| Temperature | Operating temperature: 0 to 40°C Storage temperature: -10 to 50°C | | | | | |
| Power consumption *5 | 4 W | 5 W | 4 W | 6 W | 8 W | 6 W |
| Mass | Approx. 200 g | Approx. 230 g | Approx. 220 g | Approx. 210 g | Approx. 270 g | Approx. 230 g |
| Power voltage | Power input connector (3 pins) : DC9.0 to 26.4 V. | | | | | |
| Compatible measuring unit | DG, DL series | | | | | |

Note 1 : I/O connector
Input : Reset, peak-hold start, peak-hold pause, RS trigger (RS-232C models only)
Output : Result evaluation (photocoupler)
Note 2 : BCD (36 pin half-pitch connector)
Input : Reset, peak-hold start, comparator value selection (4 settings)
Output : five digits (open collector) One of current value/maximum value/minimum value/peak-to-peak value selected and output.
Note 3 : RS-232C (8 pin mini-DIN connector)
Reset, preset value setting/recall, peak-hold start, peak-hold pause, current value hold, software version read, comparator value setting, current value/maximum value/minimum value/peak-to-peak measuring mode selection and output, key lock and release.

Note 2 : BCD (36 pin half-pitch connector)
Input : Reset, peak-hold start, comparator value selection (4 settings)
Output : five digits (open collector) One of current value/maximum value/minimum value/peak-to-peak value selected and output.
Alarm output
Note 4 : RS-TRG pin
Trigger input for RS-232C data output
Note 5 : With measuring unit connected.

LT

LT11A SERIES (for DT512)

Compact, lightweight,
and easy-to-mount counter.



Counter unit

- Compact size : DIN standard (72 mm x 72mm / 2.83" x 2.83" W x H)
- Resolution: 1, 5, 10 μm Selectable
- Suitable for panel mounting
- Direct interfacing from display unit to PLC or computer
- Current values, maximum, minimum, peak-to-peak values and GO/NO GO evaluation included as standard functions.
- ADD/SUB function (2-channel model)
- Full lineup for various applications

Dimensions

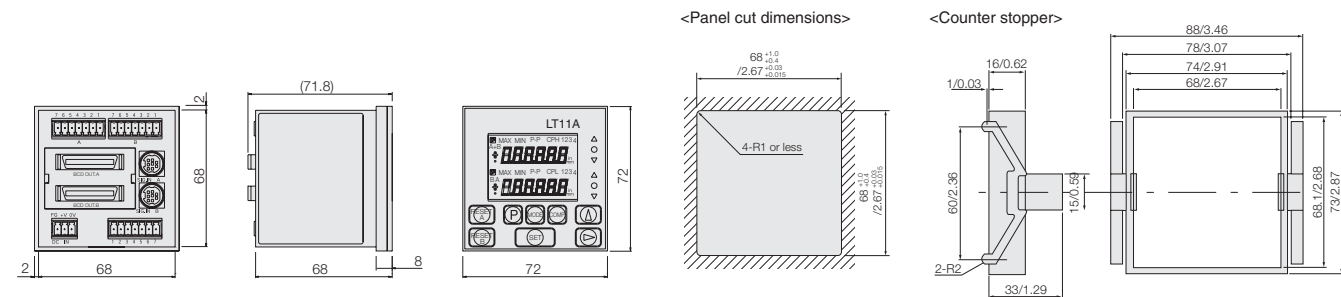

Unit : mm/inch

| Common Specifications | | | | | | | |
|-----------------------------------|--|---|--------------------------------------|---------------|---|--------------------------------------|--|
| Model | LT11A-101 | 101B | 101C | 201 | 201B | 201C | |
| Display | 5 digit backlit LCD, mode display | | | | | | |
| I/O | Measuring unit input | 1 channel | | | 2 channel | | |
| | I/O connectors *1 | ○ | | | | | |
| | BCD *2 | — | ○ | — | — | ○ | |
| | RS-232C *3 | — | — | ○ | — | ○ | |
| | RS-TRG *4 | — | — | ○ | — | ○ | |
| Reset function | Reset key or external input (I/O connectors) | | | | | | |
| | — | BCD terminal | RS-232C command | — | BCD terminal | RS-232C command | |
| Preset function | Preset value set with preset key, recalled with reset key. | | | | | | |
| | — | Recalled with BCD reset terminal | Set or recalled with RS-232C command | — | Recalled with BCD reset terminal | Set or recalled with RS-232C command | |
| Comparator function | Three-level comparator Comparator value set with keys on the front panel. Result evaluation: LED and I/O connector output (photocoupler) | | | | | | |
| | — | Up to 4 values can be set for comparator (key input). Switched with BCD terminal. | Set with RS-232C command | — | Up to 4 values can be set for comparator (key input). Switched with BCD terminal. | Set with RS-232C command | |
| Peak hold function | Maximum, minimum, and peak-to-peak values. Measuring started by the start input of the I/O connector; update stop by pause input. | | | | | | |
| | — | Can be started with the BCD terminal. | RS-232C can set or start. | — | Can be started with the BCD terminal. | RS-232C can set or start. | |
| Resolution | 0.001 mm, 0.005 mm, 0.01 mm selectable | | | | | | |
| Direction | Can be switched | | | | | | |
| Maximum response speed | 100 m/min | | | 80 m/min | | | |
| Addition and subtraction function | A+B, A-B, B-A can be set with the direction setting. | | | | | | |
| Alarm | Displayed on LCD or the I/O connector's comparator outputs are all "H" (OFF). | | | | | | |
| | — | BCD alarm terminal "H" (OFF) | — | — | BCD alarm terminal "H" (OFF) | — | |
| Data storage | Resolution, direction, comparator value, preset value, modes, etc. | | | | | | |
| | — | BCD sign | Data signalling rate, etc. | — | BCD sign | Data signalling rate, etc. | |
| Temperature | Operating temperature: 0 to 40°C Storage temperature: -10 to 50°C | | | | | | |
| Power consumption *5 | 1.8 W | 2.9 W | 2.0 W | 2.3 W | 4.0 W | 2.5 W | |
| Mass | Approx. 200 g | Approx. 230 g | Approx. 220 g | Approx. 210 g | Approx. 270 g | Approx. 230 g | |
| Power voltage | Power input connector (3 pins) : DC9.0 to 26.4 V. | | | | | | |
| Compatible measuring unit | DT512 series | | | | | | |

Note 1 : I/O connector

Input : Reset, peak-hold start, peak-hold pause, RS trigger (RS-232C models only)
Output : Result evaluation (photocoupler)

Note 3 : RS-232C (8 pin mini-DIN connector)

Reset, preset value setting/recall, peak-hold start, peak-hold pause, current value hold, software version read, comparator value setting, current value/maximum value/minimum value/peak-to-peak measuring mode selection and output, key lock and release.

Note 2 : BCD (36 pin half-pitch connector)

Input : Reset, peak-hold start, comparator value selection (4 settings)
Output : five digits (open collector) One of current value/maximum value/minimum value/peak-to-peak value selected and output.

Alarm output

Note 4 : RS-TRG pin

Trigger input for RS-232C data output

Note 5 : With measuring unit connected.

LT

LT10A SERIES (for DT12/32)

Compact, lightweight,
and easy-to-mount counter.



Counter unit

- Compact size : DIN standard (72 mm x 72 mm / 2.83" x 2.83" W x H)
- Resolution : 5, 10 μm Selectable
- Suitable for panel mounting
- Direct interfacing from display unit to PLC or computer
- Current values, maximum, minimum, peak-to-peak values and GO/NO GO evaluation included as standard functions.
- ADD/SUB function (2-channel model)
- Full lineup for various applications

Dimensions

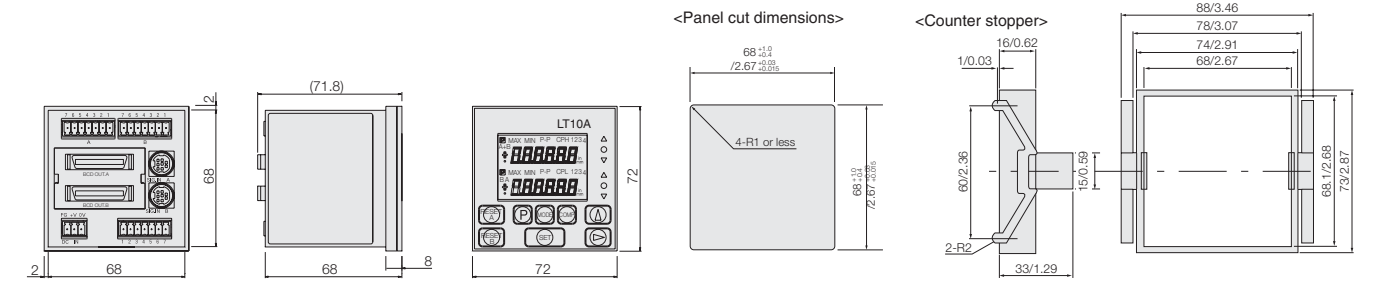

Unit : mm/inch

| Common Specifications | | | | | | | |
|-----------------------------------|--|---|--------------------------------------|---------------|---|--------------------------------------|--|
| Model | LT10A-105 | 105B | 105C | 205 | 205B | 205C | |
| Display | 5 digit backlit LCD, mode display | | | | | | |
| I/O | Measuring unit input | 1 channel | | | 2 channel | | |
| | I/O connectors *1 | ○ | | | | | |
| | BCD *2 | — | ○ | — | — | ○ | |
| | RS-232C *3 | — | — | ○ | — | ○ | |
| | RS-TRG *4 | — | — | — | — | ○ | |
| Reset function | Reset key or external input (I/O connectors) | | | | | | |
| | — | BCD terminal | RS-232C command | — | BCD terminal | RS-232C command | |
| Preset function | Preset value set with preset key, recalled with reset key. | | | | | | |
| | — | Recalled with BCD reset terminal | Set or recalled with RS-232C command | — | Recalled with BCD reset terminal | Set or recalled with RS-232C command | |
| Comparator function | Three-level comparator Comparator value set with keys on the front panel. Result evaluation: LED and I/O connector output (photocoupler) | | | | | | |
| | — | Up to 4 values can be set for comparator (key input). Switched with BCD terminal. | Set with RS-232C command | — | Up to 4 values can be set for comparator (key input). Switched with BCD terminal. | Set with RS-232C command | |
| Peak hold function | Maximum, minimum, and peak-to-peak values. Measuring started by the start input of the I/O connector; update stop by pause input. | | | | | | |
| | — | Can be started with the BCD terminal. | RS-232C can set or start. | — | Can be started with the BCD terminal. | RS-232C can set or start. | |
| Resolution | 0.005 mm, 0.01 mm selectable | | | | | | |
| Direction | Can be switched | | | | | | |
| Maximum response speed | 100 m/min | | | 80 m/min | | | |
| Addition and subtraction function | A+B, A-B, B-A can be set with the direction setting. | | | | | | |
| Alarm | Displayed on LCD or the I/O connector's comparator outputs are all "H" (OFF). | | | | | | |
| | — | BCD alarm terminal "H" (OFF) | — | — | BCD alarm terminal "H" (OFF) | — | |
| Data storage | Resolution, direction, comparator value, preset value, modes, etc. | | | | | | |
| | — | BCD sign | Data signalling rate, etc. | — | BCD sign | Data signalling rate, etc. | |
| Temperature | Operating temperature: 0 to 40°C Storage temperature: -10 to 50°C | | | | | | |
| Power consumption *5 | 1.8 W | 2.9 W | 2.0 W | 2.3 W | 4.0 W | 2.5 W | |
| Mass | Approx. 200 g | Approx. 230 g | Approx. 220 g | Approx. 210 g | Approx. 270 g | Approx. 230 g | |
| Power voltage | Power input connector (3 pins) : DC9.0 to 26.4 V. | | | | | | |
| Compatible measuring unit | DT12/32 series | | | | | | |

Note 1 : I/O connector

Input : Reset, peak-hold start, peak-hold pause, RS trigger (RS-232C models only)
Output : Result evaluation (photocoupler)

Note 3 : RS-232C (8 pin mini-DIN connector)

Reset, preset value setting/recall, peak-hold start, peak-hold pause, current value hold, software version read, comparator value setting, current value/maximum value/minimum value/peak-to-peak measuring mode selection and output, key lock and release.

Note 2 : BCD (36 pin half-pitch connector)

Input : Reset, peak-hold start, comparator value selection (4 settings)
Output : five digits (open collector) One of current value/maximum value/minimum value/peak-to-peak value selected and output.

Alarm output

Note 4 : RS-TRG pin

Trigger input for RS-232C data output

Note 5 : With measuring unit connected.

LY

LY71

For measurements and control in diverse field uses.
The required output board can be extended.

- Various outputs are enabled by mounting extension boards
 - BCD Output (Option)
 - Comparator Function: Relay / Open-collector (Option)
- Peak Hold Function Convenient for Statistical Measurement
- Convenient External Input Functions for Automatic Measurement
- Display Resolution Switching ● Data Storage.
- Reset/Preset/Restart ● Detecting Reference Point of Measurement Unit
- Scaling ● Flicker Control



Counter unit

Dimensions

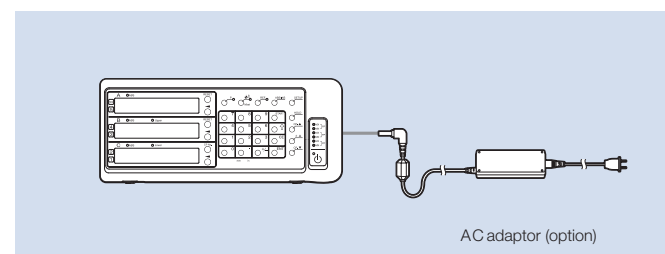
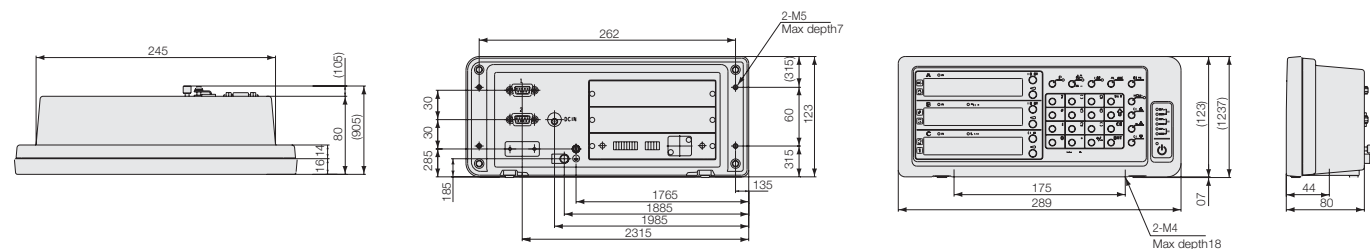

AC adaptor (option)

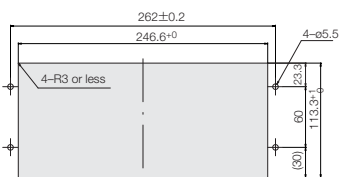

Mounting the counter unit from the panel front.

Unit : mm/inch

*Please refer to p54 for the details of the screw.

Specifications

| Model | LY71 |
|---------------------------------|---|
| Display | 7 digits and minus display, Color amber |
| Number of input shafts | 1 or 2 axes (2-axis add function available; addition only is displayed when adding) |
| Display data | Current (1st axis, 2nd axis, addition axis), maximum, minimum and peak-to-peak values |
| Measuring unit input resolution | Standard : 0.1 μm, 0.5 μm, 1 μm, 5 μm, 10 μm, 1 s, 10 s, 1 min, 10 min Expanded : 100 μm, 50 μm, 25 μm, 20 μm, 2 μm, 0.05 μm, and 1 degree can be added. |
| Input signal | A/B quadrature signal, Z signal (Conforms to EIA-422) |
| Display resolution | Measuring unit input resolution or higher and supported inch units Inch: Basic : 0.000005", 0.00001", 0.00005", 0.0002", 0.0005" Inch: Expanded: 0.000002", 0.0001", 0.001", 0.002", 0.005" |
| Minimum input phase difference | 100 ns |
| Alarm display | Measuring unit disconnected, Excess speed, Maximum display amount exceeded, Power failure, Error in stored data |
| Reset | Current value reset, Alarm cancel |
| Restart | Restart of peak value calculation for each axis/all axes |
| Preset | It is possible to store/edit up to three values for each axis. |
| Master calibration function | The master calibration value is relocated when going past the reference point after the power is turned on. |
| Datum point operations | It is possible to store/edit one value for each axis (when not using the master calibration function). |
| Reference point operations | It is possible to store/edit one value for each axis (when not using the master calibration function). |
| Hold function | Selectable from latch and pause Latch : Display held while latched (Display hold) Pause : Peak calculation stopped while paused (Peak calculation hold) |
| Linear compensation | A fixed compensation amount is applied to the measuring unit's count value. Compensation amount Standard: ±600 μm/m (Expanded: ±1000 μm/m) |
| Scaling | Scaling factor: 0.100000 to 9.999999 |
| Power supply | DC 12 V Rating 0.75 A Max. 1 A AC 100 V to 240 V ±10 % When using the AC adaptor PSC-22 (For U.S. only) or PSC-23 (For Europe and other countries) *Option |
| Power consumption | MAX. 32 VA connected at the AC adaptor. |
| Operating temperature | 0 to 40 °C (no condensation) |
| Storage temperature | -20 to 60 °C (no condensation) |
| Mass | Approx. 1.5 kg |

LY

LY72

For measurements and control in diverse field uses.
Multifunction counter with RS-232C interface

- RS-232C standard function
- Peak Hold Function Convenient for Statistical Measurement
- Convenient External Input Functions for Automatic Measurement
- Display Resolution Switching
- Data Storage.
- Reset/Preset/Restart
- Detecting Reference Point of Measurement Unit
- Scaling ● Flicker Control



Counter unit

Dimensions

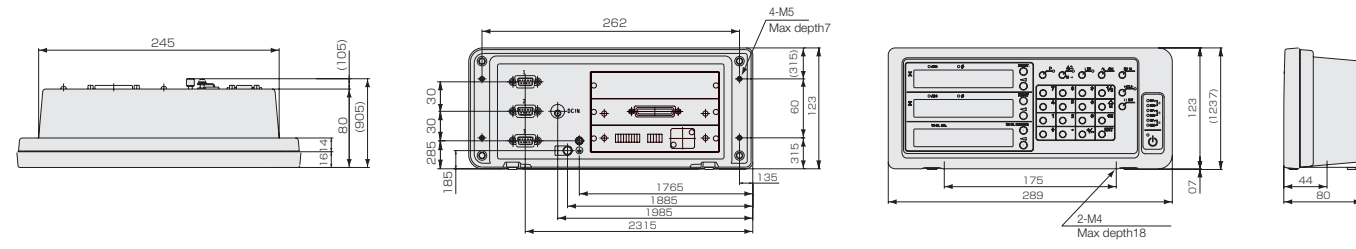

*Please refer to LY71 panel cut-out diagram.

*Please refer to p54 for the details of the screw.

Unit : mm/inch

Specifications

| Model | LY72 | |
|---------------------------------|---|--|
| Specifications by application | Applications as gauge (set axis labels A, B, and C) | Applications as scale (set axis labels X, Y, and Z) |
| Display | 7 digits and minus display, Color amber | |
| Number of input shafts | 1 to 3 axis | |
| Display data | Current (1st axis, 2nd axis, addition axis), maximum, minimum and peak-to-peak values | Current (1st axis, 3rd axis, addition axis) |
| Measuring unit input resolution | Standard : 0.1 μm, 0.5 μm, 1 μm, 5 μm, 10 μm, 1 s, 10 s, 1 min, 10 min Expanded : 100 μm, 50 μm, 25 μm, 20 μm, 2 μm, 0.05 μm, and 1 degree can be added. | |
| Input signal | A/B quadrature signal, Z signal (Conforms to EIA-422) | |
| Display resolution | Measuring unit input resolution or higher and supported inch units Inch: Basic : 0.000005", 0.00001", 0.00005", 0.0002", 0.0005" Inch: Expanded: 0.000002", 0.0001", 0.001", 0.002", 0.005" | |
| Minimum input phase difference | 100 ns | |
| Alarm display | Measuring unit disconnected, Excess speed, Maximum display amount exceeded, Power failure, Error in stored data | |
| Reset | Current value reset, Alarm cancel | |
| Restart | Restart of peak value calculation for each axis/all axes | |
| Preset | It is possible to store/edit up to three values for each axis. | |
| Master calibration function | The master calibration value is relocated when going past the reference point after the power is turned on. | — |
| Datum point operations | It is possible to store/edit one value for each axis (when not using the master calibration function). | |
| Reference point operations | It is possible to store/edit one value for each axis (when not using the master calibration function). | |
| Hold function | Selectable from latch and pause Latch : Display held while latched (Display hold) Pause : Peak calculation stopped while paused (Peak calculation hold) | Display hold |
| Linear compensation | A fixed compensation amount is applied to the measuring unit's count value. Compensation amount Standard: ±600 μm/m (Expanded: ±1000 μm/m) | |
| Scaling | Scaling factor: 0.100000 to 9.999999 Data format : All axes on same line/New line for each axis Peak-to-peak value Transfer rate : 38400/19200/9600/4800/2400/1200 bps Parity : None / Odd / Even Stop bit : 1 or 2 Data length : 8 bits or 7 bits | |
| RS-232C | Timer | OFF/0.2/0.5/1/5/10/30/60/300 seconds |
| | Output data selection | Current value/Maximum value/Minimum value Peak-to-Peak value |
| Power supply | DC 12 V Rating 0.75 A Max. 1 A AC 100 V to 240 V ±10 % When using the AC adaptor PSC-22 (For U.S. only) or PSC-23 (For Europe and other countries) *Option | |
| Power consumption | MAX. 32 VA connected at the AC adaptor. | |
| Operating temperature | 0 to 40 °C (no condensation) | |
| Storage temperature | -20 to 60 °C (no condensation) | |
| Mass | Approx. 1.5 kg | |

Technical information

LT Series Usage Note

I/O connector

The I/O connector on the rear panel of the counter unit has functions for Go/No Go output based on the comparator function, start input, pause input, RS-232C trigger input and reset input.

<Connector pin assignment (LT30,20A,11A,10A)>

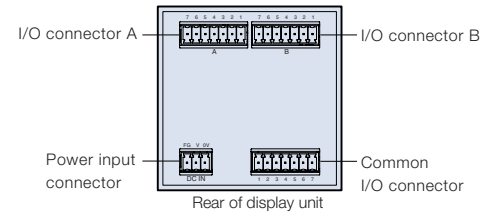

Use a shielded cable for connection to the FG pin on the rear of the display unit. (Prepare a shield cable by yourself.)

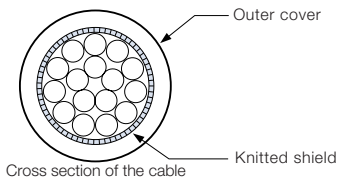

Connector used: MC1.5/7-ST-3.5 (provided) made by Phoenix Contact

Signal
(See "4-3. Function description".)
I/O connector A

| Pin No. | Signal name | IN/OUT | Signal |
|---------|-------------|--------|-----------------------------|
| 1 | GND | - | |
| 2 | NC | - | Connection prohibited |
| 3 | RESET (A) | IN | Reset input (A CH)AB |
| 4 | LO (A) | OUT | Go/No Go output Low (A CH) |
| 5 | GO (A) | OUT | Go/No Go output Go (A CH) |
| 6 | HI (A) | OUT | Go/No Go output High (A CH) |
| 7 | GND | - | |

I/O connector B (not provided for 1-channel models)

| Pin No. | Signal name | IN/OUT | Signal |
|---------|-------------|--------|-----------------------------|
| 1 | GND | - | |
| 2 | NC | - | Connection prohibited |
| 3 | RESET (B) | IN | Reset input (A CH)AB |
| 4 | LO (B) | OUT | Go/No Go output Low (B CH) |
| 5 | GO (B) | OUT | Go/No Go output Go (B CH) |
| 6 | HI (B) | OUT | Go/No Go output High (B CH) |
| 7 | GND | - | |

Installing the display unit

When mounting in a panel

1. Cut out an opening to match the dimensions shown (Fig.2)
2. Insert the display unit into the cut-out opening in the panel from the front.
3. Attach the supplied installation brackets (upper / lower) from the rear.
4. Use fingers to tighten and secure.

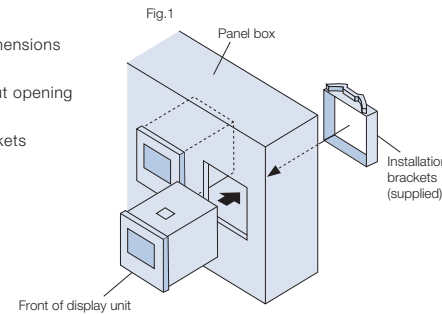

Fig.2 Cut-out dimensions

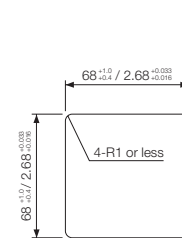
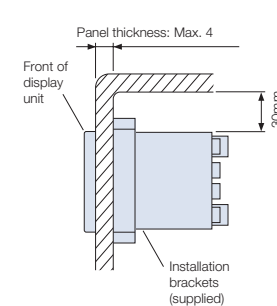

Fig.3



Unit : mm/inch

Note: When attaching the installation brackets to the display unit, leave enough space (min. 30mm) between it and the panel.

Accessories

LZ71 series Expansion boards (for LY71)

The functions of your LY71 counter unit can be expanded simply by inserting the expansion unit into the LY71.

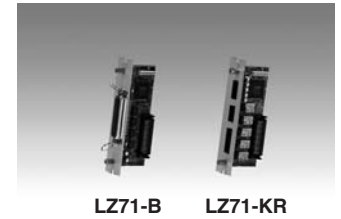

LZ71-B

- BCD output of various data
- Various output modes
- Open collector output

LZ71-KR

- Comparator function for various data
- Switching between 16 sets of data
- Open collector output/relay output

Specifications

| Model | LZ71-B |
|--|---|
| BCD output | 7 digit parallel data (4 bits x 7 digits), sign (1 bit), READY signal (1 bit) Output logic positive and negative logic can be selected individually for the data and sign by the settings. |
| Electrical specifications | Photocoupler output VCE : Recommended DC +12 to 24 V IC : Max. 15 mA/terminal, TOTAL: 300 mA Output connector: 36-pin micro ribbon connector |
| Latch | Selectable from "BCD only latch" and "BCD & display latch" by the initial settings. Input signal : DRQ1 to 3 (Photocoupler: 12 to 24 V) |
| Operating temperature | 0 to 40°C (32 to 104°F) (No condensation) |
| Storage temperature | -20 to 60°C (-4 to 140°F) (20 to 90 % RH, no condensation) |
| Model | LZ71-KR |
| Comparator function | Sets 1 to 4 comparator values for judging the data size. |
| Comparable data | Comparable data Current, maximum, minimum and peak-to-peak values. (Based on the settings) (1st axis, 2nd axis and addition axis) |
| Upper limit and lower limit combinations | Selectable from 16 data sets consisting of 1 to 4 comparator setting values. |
| Judgment outputs | 5-point output signal Photocoupler (voltage resistance: 24 V), I _c = 15 mA 5-point output signal Relay : Panasonic Electric Works, Co., Ltd. ATQ209 24 V DC, 120 V AC, 0.3 A |
| External input | Photo coupler: supports 12 to 24 V |
| Positioning function (1 point) modes | Sets the positioning data and turns the output signal on for 0.5 s when the set value and the current value match. |
| Applicable data | Current value only (1st axis or addition axis) |
| Operating temperature | 0 to 40°C (32 to 104°F) (No condensation) |
| Storage temperature | -20 to 60°C (-4 to 140°F) |

LZ71-B

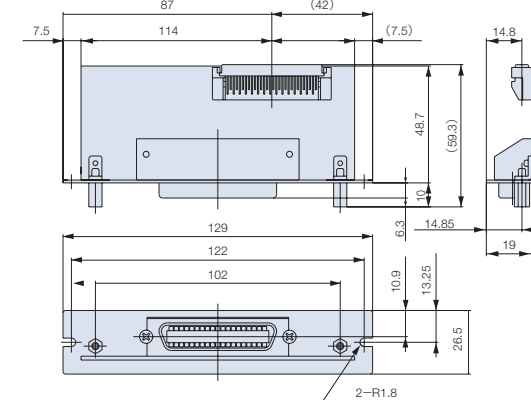

LZ71-KR

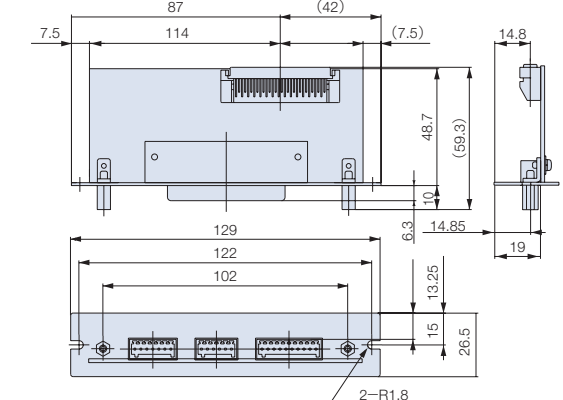

Unit : mm

Other accessories

- Cable connectors for computer connection (for U Series/ LT Series/ LY Series) DZ252 (round 8 pin ↔ D sub 9 pin) (2 m) DZ253A (round 8 pin ↔ D sub 25 pin) (2 m) DZ254 (round 8 pin ↔ unterminated end)

Connection Cables

| Measuring unit | Adapter for LT series | LT series | Interface unit | Adapter for Counter | Connection cable | Counter unit | Interpolators | Extension cables |
|------------------------------|-----------------------|-----------|---|---------------------|---|--------------|--|--|
| DK805A/B, DK805A/B, DK810A/B | — | LT30 | MG (MG10-P1/P2) (MG20-DK) (MG30-B1/B2) (MG41-NC/NE) (MG42-4) Link Cable MZ41-** | — | CE-29-*** ***=-003(0.3m) -01(1m) -05(5m) -10(10m) | LY71, 72 | — | CE-08** **=-01(1m), -03(3m), -05(5m), -10(10m), -15(15m) |
| DK10/25 | | | | | | | | CE-22** (Open-end) **=-01(1m), -03(3m), -05(5m), -10(10m) |
| DK50/100 | | | | | | | | CK-T** (Realize for flexion) CK-T12(1m), T13(3m), T14(5m), T15(10m) |
| DK155PR5/205PR5 | | | | | | | | |
| DK110NLR5 | | | | | | | | |
| DT12N/P | — | LT10A | MG (MG10-P1/P2) (MG20-DT) (MG30-B1/B2) | — | MT13 + CE-29 | LY71, 72 | MT12(for LT20A), MT13(for LT30) MT14(Cable with unterminated) | CE-08** **=-01(1m), -03(3m), -05(5m), -10(10m), -15(15m) |
| DT32N/NV/P/PV | | | | | | | | CK-T12(1m), T13(3m), T14(5m), T15(10m), CK-T10(1m) CK-T105(5m) (Realize for flexion) |
| DT512N/P | | | | | | | | — |
| DG805B/810B | — | LT20A | MG (MG10-P1/P2) (MG20-DG) (MG30-B1/B2) | — | — | LY71, LY72 | MD10A/20B ※D-sub15pin Female | — |
| DG10B/25B | | | | | | | | — |
| DG50B/100B/155B/205B | | | | | | | | — |
| DG-110B | | | | | | | | — |
| DL-B | | | | | | | | — |
| DE-BR | SZ70-2 | LT30 | SZ70-2+ MG (MG10-P1/P2) (MG20-DG) (MG30-B1/B2) | SZ70-1 | — | LY71, LY72 | — | — |

Compatible

| Measuring unit | Adapter for LT series | LT series | Adapter for Counter | Connection cable | Counter unit | Interpolators | Extension cables |
|----------------------|---|---------------|---------------------|------------------|--------------|---------------|---|
| DT32N/NV/P/PV | Interpolator MT12 LZ60-P1/P2 is required to connect to LT100. | LT20 LT100 | — | — | LY51, LY52 | — | CE-08** **=-01(1m), -03(3m), -05(5m), -10(10m), -15(15m) |
| DT512N/P | | | | | | | — |
| DT12N/P | | | | | | | — |
| DT32N/NV/P/PV | — | LT10 | — | — | LY51, LY52 | — | CK-T12(1m), T13(3m), T14(5m), T15(10m) T101(3m) T105(5m) (Realize for flexion) |
| DT512N/P | | | | | | | — |
| DG805B/810B | — | LT11 | — | — | — | — | — |
| DG10B/25B | — | LT20 LT100 | DZ51 | — | LY51, LY52 | — | — |
| DG50B/100B/155B/205B | | | | | | | — |
| DG110B | — | — | — | — | — | — | — |
| DL-B | — | LT20 LT100 | DZ51 | — | LY51, LY52 | — | — |

A description of external form chart of the screw

- When a screw thread is not mentioned in the Dimensions, It is mean numerical value base on standard pitch (National Coarse).
- The screw which conformed to ISO and JIS is enclosed.