



**Gage Block**



**Height Master**



**Reference Gages**

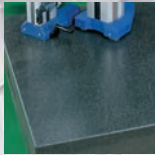

**Granite Surface Plates & Bench Comparator**



**CERA/Steel Combination Gage Block Sets**



**Step Master**



**ZERO CERA BLOCK**



**Ceramic Straight Master**

### INDEX

<b>Gage Blocks</b>	E-2-4	Tap Wrench	E-50
Metric Rectangular Gage Block Set	E-5,6	Scribers	E-51
Inch Rectangular Gage Block Set	E-7	Center Punches	E-51
Micrometer Inspection Gage Block Sets	E-8	Drive Pin Punches	E-51
Individual Metric Rectangular Gage Block	E-9,10	Center Finder	E-52
Individual Inch Rectangular Gage Block	E-11	Pin Vises	E-52
Rectangular Gage Block with CTE	E-12	Wiggler	E-52
Rectangular Gage Block Accessories	E-13-15	Optical Center Punch	E-52
Metric Square Gage Block Set	E-16	Edge & Center Finders	E-53
Inch Square Gage Block Set	E-17	Bench Center	E-53
Individual Metric Square Gage Block	E-18	Digital Protractor	E-54
Individual Inch Square Gage Block	E-19	Digital Hand Tachometers	E-55
Square Gage Block Accessories	E-20,21	<b>Granite Surface Plate</b>	
Ceraston	E-22	Granite Surface Plate Accessories	E-56
Maintenance Kit for Gage Block	E-22	Black Granite Surface Plate	E-57
Step Master	E-23	Steel Stands	E-58
Made-to-order Block & Reference	E-23	Bench Center	E-55
Gage Block Comparator GBCD-250	E-24	Digital Protractor	E-56
Gage Block Comparator GBCD-100A	E-24	Digital Hand Tachometers	E-57
<b>Height Masters</b>	E-25	Datatorq	E-58
Digital Height Master	E-26		
Riser Blocks	E-27		
Auxiliary Block Kit	E-27		
Universal Height Master	E-28		
High Accuracy Check Master HMC-H	E-29		
CERA Straight Master SM-C	E-30		
Square Master	E-31		
<b>Reference Gages</b>			
Standard Scales	E-32		
Working Standard Scales	E-32		
Steel Squares	E-33		
High Precision Square	E-33		
Knife Edge Straight Edge	E-34		
Spring Dividers and Calipers	E-34		
Combination Square Set	E-35,36		
Double Square Set	E-36		
Steel Rules	E-37,38		
Semi-Flexible Rules	E-39		
Hook Rules	E-39		
Pocket Steel Rule	E-39		
Thickness Gages	E-40		
Precision Levels	E-40		
Digital Universal Protractor	E-41		
Universal Bevel Protractor	E-42		
Protractor	E-43		
Bevel Protractor	E-43		
Depth Gage, Adjustable Angle	E-44		
Zero-It	E-44		
Zero-Setter	E-44		
Angle Gages	E-45		
Angle Blocks	E-46		
Adjustable Parallels	E-46		
Radius Gages	E-47		
Pitch Gages	E-47		
Radius Gages-Sets	E-48		
Standard Gages	E-49		
Tap and Drill Gage	E-49		
Drill Point Gage	E-49		
Thread Gage	E-49		
Center Gage	E-50		

# Gage Block

## SERIES 516

### FEATURES

Precision gage blocks are the primary standards vital to dimensional quality control in the manufacture of parts. Mitutoyo offers

a complete selection of gage blocks available in a choice of rectangular or square, metric or inch and steel or CERA (ceramic) types.

### Accuracy

Gage blocks offered by an all-round precision measuring machine manufacturer, Mitutoyo, guarantee such a high accuracy that users can use them without anxiety. Needless to say, Mitutoyo has established a traceability system for our measurement products, up to the Metrology Management Center of the National Institute of Advanced Industrial Science and Technology (AIST) and we have been certified by the Japanese government as an accredited laboratory.

### Wringing

The lapping technique is one of Mitutoyo's specialties. Our advanced lapping technique, developed for more than a half century, enables us to achieve the best flatness and surface roughness needed for gage blocks and realize a great wringing force.

### Abrasion Resistance and Dimensional Stability

High-carbon high-chrome steel is employed to sufficiently satisfy a variety of material characteristics required for gage blocks. A high degree of hardness, obtained by our heat treatment technology and that reassures users, as well as methodically repeated heat treatment, have successfully reduced deterioration change over time to the minimum.

### CERA Blocks

CERA blocks, made of ceramic materials with superior surface quality, that were developed by Mitutoyo's ultra precision machining techniques solve all problems that the steel gage block had.

#### 1. Corrosion-Resistant

Anti-corrosion treatment is not required when handled normally (i.e. with fingers), resulting in simple maintenance and storage.

#### 2. No Burrs Caused by Dents, etc.

Since the CERA Block is very hard, it will not scratch and is highly resistant to burrs. If a burr is formed, it can easily be removed with a ceramic deburring stone (Ceraston).

#### 3. Abrasion Resistant

CERA Blocks have 10 times the abrasion resistance of steel gage blocks.

#### 4. Dimensional Stability

CERA Blocks are free from dimensional change over time.

#### 5. Marking

The black characters, indicating the nominal length, are inscribed by laser and are clearly visible against the white surface of the block.

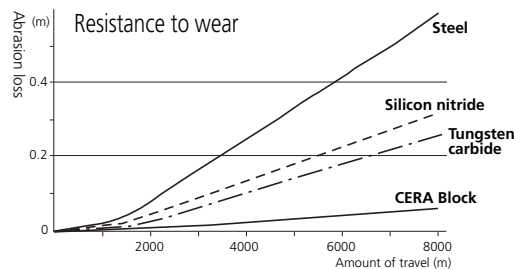

### Selecting Gage Blocks

- Select gage blocks in accordance with the combination range required. If a large length is required, add a long block set.
- Select gage blocks in accordance with the minimum length step required. Add wear block sets if necessary.
- If a set containing a large number of gage blocks is selected, the number of combination gage blocks required for a length is reduced and the number of combinations is increased. The accuracy will be retained and damage will be reduced.
- The specific gage block set for micrometer inspection and caliper inspection is available.
- If using only one length repeatedly, it is a good idea to purchase discrete gage blocks.
- The 2mm-based gage blocks, which take the base of the minimum length step as 2mm, are easy to handle and will not warp, as compared to the 1mm-based gage blocks.

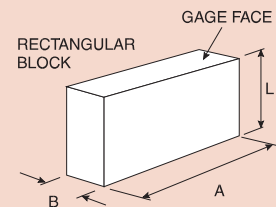

### Rectangular Block

Gage Size	Face Width (A)	Face Depth (B)
Up to 2"	1.181"	.355"
Over .2" up to 40"	1.378"	.355"
Up to 10mm	30mm	9mm
Over 10mm up to 1000mm	35mm	9mm

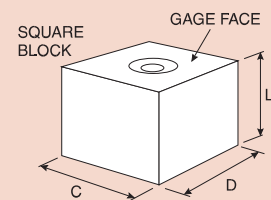

### Square Block

Gage Size	Face Width (C)	Face Depth (D)
Inch (up to 40")	.95"	.95"
Metric (up to 1000mm)	24.1mm	24.1mm

## Grade and Application

Refer to the following table to select the gage block grade according to usage.

	Applications	Grade
Workshop use	• Mounting tools and cutters	AS-1 or AS-2
	• Manufacturing gages • Calibrating instruments	0 or AS-1
Inspection use	• Inspecting mechanical parts, tools, etc.	0 or AS-1
	• Checking the accuracy of gages • Calibrating instruments	00 or 0
Calibration use	• Checking the accuracy of gage blocks for workshop • Checking the accuracy of gage blocks for inspection • Checking the accuracy of instruments	K or 00
Reference use	• Checking the accuracy of gage blocks for calibration • For academic research	K

### Grade AS-1:

These gage blocks are intended for shop floor use to set and calibrate fixtures as well as precision instruments.

### Grade 0:

This grade is used within an inspection area to verify the accuracy of plug and snap gages as well as for setting electronic measuring devices.

### Grade 00:

These higher accuracy gages are intended for use within a controlled environment by skilled inspection staff. Mainly used as reference standards for setting high precision measuring equipment and for the calibration of lower grade gage blocks.

### Grade K:

Gage blocks of this accuracy are intended for use within a temperature controlled inspection room or calibration laboratory. They should be used as masters with certificates against other gage blocks which are calibrated by comparison.

### Combination of a Required Length

Multiple combinations of gage blocks can be used to make a required length. Care should be exercised in the following points.

1. Use as few gage blocks as possible to obtain the required length. (= Select thick gage blocks whenever possible.)
2. Select gage blocks starting with the one that has least significant digit required, and then work up to ones with more significant digits.
3. There are multiple combinations for the integer part of a length. To prevent wear as much as possible, do not always use the same gage blocks.

Example combination

Required length = 45.6785mm

#### For the 1mm-based gage block set (112 pcs.)

```

1.005
1.008
1.17
17.5
+ 25
-----
45.6785mm
    
```

#### For the 2mm-based gage block set (112 pcs.)

```

2.005
2.008
2.17
14.5
+ 25
-----
45.6785mm
    
```

## 6. Anti-magnetic Nature Keeps Away Steel Powders

### 7. High wringing force

An even, dense tissue can maintain a strong wringing force.



### 8. Material of CERA block

Property	Material	CERA Block (ZrO <sub>2</sub> )	Steel (Fe)	Carbide (WC-Co)	Silicon nitride (Si <sub>3</sub> N <sub>4</sub> )
Hardness (HV)		1350	800	1650	1500
Coefficient of thermal expansion (10 <sup>-6</sup> /K)		9.3±0.5	10.8±0.5	5.5±1.0	2
Flexural strength by 3-point bending (MPa)		1270	1960	1960	580
Fracture toughness K1c (MPa•m <sup>1/2</sup> )		7	120	12	6.5
Young's modulus x104 (MPa)		20.6	20.6	61.8	28.4
Poisson's ratio		0.3	0.3	0.2	0.3
Specific gravity		6.0	7.8	14.8	3.2
Thermal conductivity (W/m•k)		2.9	54.4	79.5	16.7

### 9. Closest Expansion Coefficient to Steel

The thermal expansion coefficient of a CERA Block is quite similar to that of a steel gage block.

### 10. Highly Resistant Against Drops and Other Shocks

The CERA Block material is one of the toughest ceramics materials. It is extremely difficult to crack under normal use.

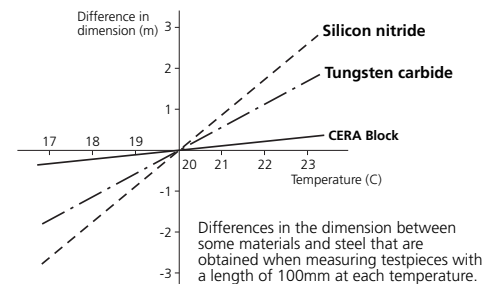

## Features of Square Gage Blocks

### 1. Perfect wringing is possible using the center hole.

After wringing the square gage blocks, an optional tie rod can be inserted through the center hole to fix the blocks using a screw.

### 2. A height reference standard can easily be made.

A precision height reference standard can be made easily and inexpensively using accessories such as the plain jaw and block base.

### 3. A dedicated inspection jig can be easily be made.

A dedicated inspection jig for periodic inspection of instruments can be made easily and inexpensively.

### 4. A wide measuring surface with cross section dimensions of [24.1 x 24.1mm / .95 x .95"] is available.

A square gage block can retain stable orientation both longitudinally and laterally. A wide range of application measurements can be made, including cutting tool positioning, angle measurement with a sine bar, taper measurement with a roller, and inspection of depth micrometers.



## Long and Ultra-Thin Gage Blocks

Mitutoyo offers extra thin gage blocks from 0.10 mm to 0.99 mm (increments of 0.01 mm) as well as long gage blocks up to 1,000 mm as standard products.

# Gage Block

## SERIES 516

### Accuracies of Mitutoyo Gage Blocks

All Mitutoyo gage blocks meet or exceed all known specifications. The flatness, parallelism and surface finish necessary to achieve the required accuracies are the same as or better than government requirements.

### ASME (American Society of Mechanical Engineers) Deviations and Tolerance on Length for Metric and inch Gage Blocks: ASME B89.1.9-2002 (USA)

Nominal Length Range l <sub>n</sub> in inches	Calibration Grade K		Grade 00		Grade 0		Grade AS-1		Grade AS-2	
	Limit Deviations of Length at any Point From Nominal Length ± l <sub>e</sub> μin.	Tolerance for the Variation In Length ± l <sub>v</sub> μin.	Limit Deviations of Length at any Point From Nominal Length ± l <sub>e</sub> μin.	Tolerance for the Variation In Length ± l <sub>v</sub> μin.	Limit Deviations of Length at any Point From Nominal Length ± l <sub>e</sub> μin.	Tolerance for the Variation In Length ± l <sub>v</sub> μin.	Limit Deviations of Length at any Point From Nominal Length ± l <sub>e</sub> μin.	Tolerance for the Variation In Length ± l <sub>v</sub> μin.	Limit Deviations of Length at any Point From Nominal Length ± l <sub>e</sub> μin.	Tolerance for the Variation In Length ± l <sub>v</sub> μin.
l <sub>n</sub> ≤ .05	12	2	4	2	6	4	12	6	24	12
.05 l <sub>n</sub> ≤ .4	10	2	3	2	5	4	8	6	18	12
.45 l <sub>n</sub> ≤ 1	12	2	3	2	6	4	12	6	24	12
1 l <sub>n</sub> ≤ 2	16	2	4	2	8	4	16	6	32	12
2 l <sub>n</sub> ≤ 3	20	2	5	3	10	4	20	6	40	14
3 l <sub>n</sub> ≤ 4	24	3	6	3	12	5	24	8	48	14
4 l <sub>n</sub> ≤ 5	32	3	8	3	16	5	32	8	64	16
5 l <sub>n</sub> ≤ 6	32	3	8	3	16	5	32	8	64	16
6 l <sub>n</sub> ≤ 7	40	4	10	4	20	6	40	10	80	16
7 l <sub>n</sub> ≤ 8	40	4	10	4	20	6	40	10	80	16
8 l <sub>n</sub> ≤ 10	48	4	12	4	24	6	48	10	104	18
10 l <sub>n</sub> ≤ 12	56	4	14	4	28	7	56	10	112	20
12 l <sub>n</sub> ≤ 16	72	5	18	5	36	8	72	12	144	20
16 l <sub>n</sub> ≤ 20	88	6	20	6	44	10	88	14	176	24
20 l <sub>n</sub> ≤ 24	104	6	25	6	52	10	104	16	200	28
24 l <sub>n</sub> ≤ 28	120	7	30	7	60	12	120	18	240	28
28 l <sub>n</sub> ≤ 32	136	8	34	8	68	12	136	20	260	32
32 l <sub>n</sub> ≤ 36	152	8	38	8	76	14	152	20	300	36
36 l <sub>n</sub> ≤ 40	160	10	40	10	80	16	168	24	320	40

Nominal Length Range l <sub>n</sub> in mm	Calibration Grade K		Grade 00		Grade 0		Grade AS-1		Grade AS-2	
	Limit Deviations of Length at any Point From Nominal Length ± l <sub>e</sub> μm	Tolerance for the Variation In Length ± l <sub>v</sub> μm	Limit Deviations of Length at any Point From Nominal Length ± l <sub>e</sub> μm	Tolerance for the Variation In Length ± l <sub>v</sub> μm	Limit Deviations of Length at any Point From Nominal Length ± l <sub>e</sub> μm	Tolerance for the Variation In Length ± l <sub>v</sub> μm	Limit Deviations of Length at any Point From Nominal Length ± l <sub>e</sub> μm	Tolerance for the Variation In Length ± l <sub>v</sub> μm	Limit Deviations of Length at any Point From Nominal Length ± l <sub>e</sub> μm	Tolerance for the Variation In Length ± l <sub>v</sub> μm
l <sub>n</sub> ≤ 0.5	0.30	0.05	0.10	0.05	0.14	0.10	0.30	0.16	0.60	0.30
0.5 l <sub>n</sub> ≤ 10	0.20	0.05	0.07	0.05	0.12	0.10	0.20	0.16	0.45	0.30
10 l <sub>n</sub> ≤ 25	0.30	0.05	0.07	0.05	0.14	0.10	0.30	0.16	0.60	0.30
25 l <sub>n</sub> ≤ 50	0.40	0.06	0.10	0.06	0.20	0.10	0.40	0.18	0.80	0.30
50 l <sub>n</sub> ≤ 75	0.50	0.06	0.12	0.06	0.25	0.12	0.50	0.18	1.00	0.35
75 l <sub>n</sub> ≤ 100	0.60	0.07	0.15	0.07	0.30	0.12	0.60	0.20	1.20	0.35
100 l <sub>n</sub> ≤ 150	0.80	0.08	0.20	0.08	0.40	0.14	0.80	0.20	1.60	0.40
150 l <sub>n</sub> ≤ 200	1.00	0.09	0.25	0.09	0.50	0.16	1.00	0.25	2.00	0.40
200 l <sub>n</sub> ≤ 250	1.20	0.10	0.30	0.10	0.60	0.16	1.20	0.25	2.40	0.45
250 l <sub>n</sub> ≤ 300	1.4	0.10	0.35	0.10	0.70	0.18	1.40	0.25	2.80	0.50
300 l <sub>n</sub> ≤ 400	1.80	0.12	0.45	0.12	0.90	0.20	1.80	0.30	3.60	0.50
400 l <sub>n</sub> ≤ 500	2.20	0.14	0.50	0.14	1.10	0.25	2.20	0.35	4.40	0.60
500 l <sub>n</sub> ≤ 600	2.60	0.16	0.65	0.16	1.30	0.25	2.60	0.40	5.00	0.70
600 l <sub>n</sub> ≤ 700	3.00	0.18	0.75	0.18	1.50	0.30	3.00	0.45	6.00	0.70
700 l <sub>n</sub> ≤ 800	3.40	0.20	0.85	0.20	1.70	0.30	3.40	0.50	6.50	0.80
800 l <sub>n</sub> ≤ 900	3.80	0.20	0.95	0.20	1.90	0.35	3.80	0.50	7.50	0.90
900 l <sub>n</sub> ≤ 1000	4.20	0.25	1.00	0.25	2.00	0.40	4.20	0.60	8.00	1.00

### Mitutoyo Gage Blocks and Inspection Certificates

A Certificate of Inspection is furnished with all Mitutoyo gage blocks with a serial number on the case and an identification number on each block. The deviation of each block is registered. For this inspection, each gage block is measured relative to the upper level master using a gage block comparator. Grade K gage blocks are manufactured by absolute measurement using an interferometer. The gage block set and discrete gage block are supplied with a Certificate of Calibration. The Certificate of Calibration specifies the deviation from the nominal length. (Comparative measurement, however, is performed for all square gage blocks.)

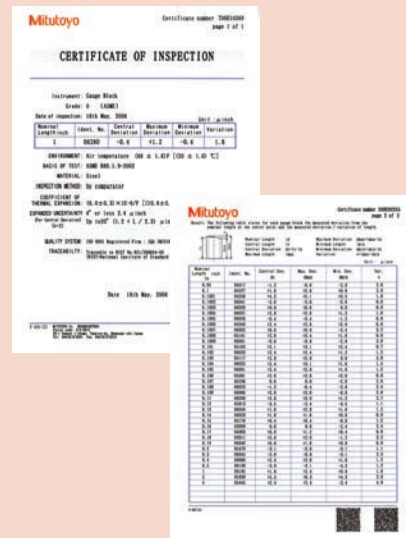

A Certificate of Accuracy, traceable to the NIST, is furnished with each MITUTOYO gage block set and individual block

# Metric Rectangular Gage Block Set

## SERIES 516 — 1mm Base Block Set



Steel 112-block set



Steel 103-block set



Steel 47-block set



CERA 112-block set



CERA 56-block set



CERA/Steel combination  
47-block set

Provided with Inspection Certificate

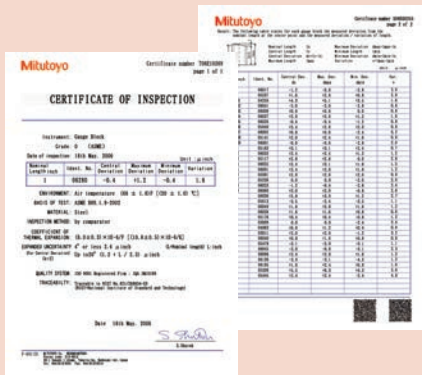

### SPECIFICATIONS

#### 1mm Base Block Set

Blocks per set	Order No.		Grade	Blocks included in set		
	Steel	CERA		Size	Step	Qty.
112	516-531-56	516-541-56	K	1.0005		1
	516-937-26	516-337-26	00	1.001 - 1.009	0.001	9
	516-938-26	516-338-26	0	1.01 - 1.49	0.01	49
	516-939-26	516-339-26	AS-1	0.5 - 24.5	0.5	49
	516-940-26	516-340-26	AS-2	25 - 100	25	4
	103	516-533-56	516-542-56	K	1.005	
103	516-941-26	516-341-26	00	1.01 - 1.49	0.01	49
	516-942-26	516-342-26	0	0.5 - 24.5	0.5	49
	516-943-26	516-343-26	AS-1	25 - 100	25	4
	516-944-26	516-344-26	AS-2			
	87	516-535-56	515-543-56	K	1.001 - 1.009	0.001
87	516-945-26	516-345-26	00	1.01 - 1.49	0.01	49
	516-946-26	516-346-26	0	0.5 - 9.5	0.5	19
	516-947-26	516-347-26	AS-1	10 - 100	10	10
	516-948-26	516-348-26	AS-2			
	56	516-536-56	516-544-56	K	0.5	
56	516-953-26	516-353-26	00	1.001 - 1.009	0.001	9
	516-954-26	516-354-26	0	1.01 - 1.09	0.01	9
	516-955-26	516-355-26	AS-1	1.1 - 1.9	0.1	9
	516-956-26	516-356-26	AS-2	1 - 24	1	24
	47	516-537-56	516-545-56	K	1.005	
47	516-957-26	516-357-26	00	1.01 - 1.09	0.01	9
	516-958-26	516-358-26	0	1.1 - 1.9	0.1	9
	516-959-26	516-359-26	AS-1	1 - 24	1	24
	516-960-26	516-360-26	AS-2	25 - 100	25	4



# Metric Rectangular Gage Block Set

**SERIES 516 — Long Block Set, Wear Block Set**



CERA 8-block set



Steel 8-block set

Provided with Inspection Certificate

## SPECIFICATIONS

### Long Block Set

Blocks per set	Order No.		Grade	Blocks included in set		
	Steel	CERA		ASME	Size	Step
8	—	516-547-56	K	25-200	25	8
	—	516-164-26	00	—	—	—
	516-115-26	516-165-26	0	—	—	—
	516-116-26	516-166-26	AS-1	—	—	—
8	516-540-26	516-546-56	K	125 - 175	25	3
	516-701-26	516-731-26	00	200 - 250	50	2
	516-702-26	516-732-26	0	300 - 500	100	3
	516-703-26	516-733-26	AS-1	—	—	—

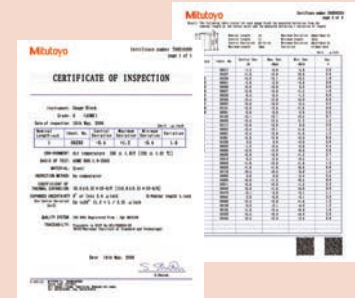

CERA 2-block set



Carbide 2-block

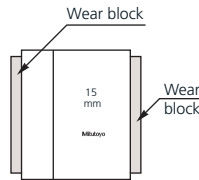

## SPECIFICATIONS

### Wear Block Set

Blocks per set	Order No.*		Grade	Blocks included in set	
	Carbide	CERA		ASME	Size
2	516-807-26	516-832-26	0	1	2
	516-806-26	516-833-26	AS-1	—	—
2	516-803-26	516-830-26	0	2	2
	516-802-26	516-831-26	AS-1	—	—

# Inch Rectangular Gage Block Set

**SERIES 516 — Inch Block Set, Thin Block Set, Long Block Set, Wear Block Set**

## SPECIFICATIONS

### Inch Block Set

Blocks per set	Order No.			Grade	Blocks included in set		
	Steel	CERA	Steel/CERA		Size	Step	Qty.
<b>81</b>	516-549-56	516-557-56	—	K	.1001 – .1009	.0001	9
	516-901-26	516-301-26	—	00	.101 – .149	.001	49
	516-902-26	516-302-26	516-302-27**	0	.05 – .95	.05	19
	516-903-26	516-303-26	—	AS-1	1 - 4	1	4
	516-904-26	516-304-26	—	AS-2			
<b>35</b>	516-550-56	516-558-56	—	K	.10005		1
	516-913-26	516-313-26	—	00	.1001 – .1009	.0001	9
	516-914-26	516-314-26	—	0	.101 – .109	.001	9
	516-915-26	516-315-26	—	AS-1	.11 – .19	.01	9
	516-916-26	516-316-26	—	AS-2	.1 - .3	.1	3
					.5, 1, 2, 4	4	

\*\*CERA blocks are adopted for frequently-used blocks.  
81-block set: All are CERA blocks. Except 2", 3", and 4" are Steel blocks

Provided with Inspection Certificate

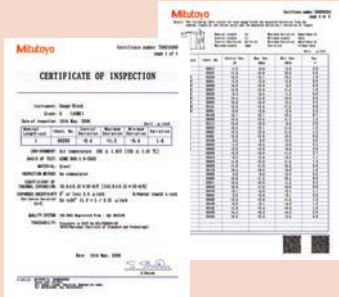

## SPECIFICATIONS

### Thin Block Set

Blocks per set	Order No.		Grade	Blocks included in set		
	Steel	CERA		Size	Step	Qty.
<b>28</b>	516-551-56	—	K	.02005		1
	516-917-26	—	00	.0201 – .0209	.0001	9
	516-918-26	—	0	.021 – .029	.001	9
	516-919-26	—	AS-1	.01 – .09	.01	9
	516-920-26	—	AS-2			
<b>10</b>	516-926-26	—	0	.005 - .050	.005	10
	516-927-26	—	AS-1			

## SPECIFICATIONS

### Long Block Set

Blocks per set	Order No.		Grade	Blocks included in set		
	Steel	CERA		Size	Step	Qty.
<b>8</b>	516-126-26	516-176-26	0	1-8	1	8
	516-127-26	516-177-26	AS-1			
<b>8</b>	—	516-564-56	K	5 - 7	1	3
	—	516-741-26	00	8, 10, 12	2	3
	516-712-26	516-742-26	0	16, 20	4	2
	516-713-26	516-743-26	AS-1			

## SPECIFICATIONS

### Wear Block Set

Blocks per set	Order No.		Grade	Blocks included in set	
	Carbide	CERA		Size	Qty.
<b>2</b>	516-809-26	516-836-26	0	.05	2
	516-808-26	516-837-26	AS-1		
<b>2</b>	516-805-26	516-834-26	0	.1	2
	516-804-26	516-835-26	AS-1		

# Micrometer Inspection Gage Block Sets

## SERIES 516

- Can be fixed a series of gage blocks to be used for micrometer inspection.
- Can be measured in both vertical and horizontal posture.
- Parallelism is measured by attaching the optical parallel (optional accessory) to the GB set.

### SPECIFICATIONS

Metric  Micro Checker (holder only)	
Order No.	516-607
Applicable gage block set	516-106-26, 516-107-26, 516-156-26, 516-157-26
Applicable gage block size (mm)	2.5, 5.1, 7.7, 10.3, 12.9, 15, 17.6, 20.2, 22.8, 25

Inch/Metric  Micro Checker (holder only)	
Order No.	516-608
Applicable gage block set	516-921-26, 516-922-26, 516-923-26, 516-321-26, 516-322-26, 516-323-26
Applicable gage block size (inch)	.105, .210, .315, .420, .5, .605, .815, .920

Metric Block Set 				
Blocks per set	Order No.		Grade	Blocks included in set
	Steel	CERA		
10	516-103-26	516-152-26	0	1.00, 1.25, 1.50, 2, 3, 5, 10, 15, 20, 25mm
	516-101-26	516-153-26	AS-1	
10	516-106-26	516-156-26	0	2.5, 5.1, 7.7, 10.3, 12.9, 15, 17.6, 20.2, 22.8, 25mm • Optical parallel (t = 12mm)
	516-107-26	516-157-26	AS-1	

Inch Block Set 				
Blocks per set	Order No.		Grade	Blocks included in set
	Steel	CERA		
10	516-552-56	516-559-56	K	.105, .210, .315, .420, .500, .605, .710, .815, .920, 1" • Optical parallel (t = .5")
	516-921-26	516-321-26	00	
	516-922-26	516-322-26	0	
	516-923-26	516-323-26	AS-1	
10	516-529-26*	516-319-26*	0	.087, .189, .307, .409, .472, .598, .669, .772, .890, 1" • Optical parallel (t = .5")
9	516-554-56	516-561-56	K	.0625, .100, .125, .200, .250, .300, .500, 1, 2" • Optical parallel (t = .5")
	516-929-26	516-333-26	00	
	516-930-26	516-334-26	0	
	516-931-26	516-335-26	AS-1	
9	—	516-563-56	K	.0625, .100, .125, .200, .250, .300, .500, 1, 2"
	—	516-329-26	00	
	516-934-26	516-330-26	0	
	516-935-26	516-331-26	AS-1	

\* For QuantuMike

### Micro Checker



(Gage Blocks are optional)

# Bore Gage Calibration Kit

## SERIES 516

### SPECIFICATIONS

Blocks per set	Order No.	Grade	Blocks included in set
	Carbide		Size
9	516-120-26	0	.04", .08", .16", .2", .4", .8", 1", 2", 3" 2pcs. of 619970 (plain jaw) and 619004 (160mm holder)



# Individual Metric Rectangular Gage Block

## FEATURES

- If using only one length repeatedly, it is a good idea to purchase discrete gage blocks.
- Each gage block is supplied with a Certificate of Inspection.
- Each Grade K gage block of ASME standard is specially supplied with a Certificate of Calibration which certifies that the gage block was manufactured through interferometry.



## Suffix Number for Selecting Standard and Certificate Provided

ASME	
Grade	Steel, CERA
K	-516**
00	-521*
0	-531*
AS-1	-541*
AS-2	-551*

\* provided with Inspection Certificate  
 \*\* provided with Calibration Certificate and Inspection Certificate

Example: 611821-521  
 0.1mm gage block in grade 00.  
 We make custom length gage block length:  
 0.1-1000mm



Inspection Certificate

## SPECIFICATIONS

Metric Block								
Length (mm)	Order No.		Length (mm)	Order No.		Length (mm)	Order No.	
	Steel	CERA		Steel	CERA		Steel	CERA
0.1	611821	—	0.53	611894	—	0.96	611937	—
0.11	611860	—	0.54	611895	—	0.97	611938	—
0.12	611861	—	0.55	611896	—	0.98	611939	—
0.13	611862	—	0.56	611897	—	0.99	611940	—
0.14	611863	—	0.57	611898	—	0.991	611551	613551
0.15	611822	—	0.58	611899	—	0.992	611552	613552
0.16	611864	—	0.59	611900	—	0.993	611553	613553
0.17	611865	—	0.6	611901	—	0.994	611554	613554
0.18	611866	—	0.61	611902	—	0.995	611555	613555
0.19	611867	—	0.62	611903	—	0.996	611556	613556
0.2	611823	—	0.63	611904	—	0.997	611557	613557
0.21	611868	—	0.64	611905	—	0.998	611558	613558
0.22	611869	—	0.65	611906	—	0.999	611559	613559
0.23	611870	—	0.66	611907	—	1	611611	613611
0.24	611871	—	0.67	611908	—	1.0005	611520	613520
0.25	611824	—	0.68	611909	—	1.001	611521	613521
0.26	611872	—	0.69	611910	—	1.002	611522	613522
0.27	611873	—	0.7	611911	—	1.003	611523	613523
0.28	611874	—	0.71	611912	—	1.004	611524	613524
0.29	611875	—	0.72	611913	—	1.005	611525	613525
0.3	611825	—	0.73	611914	—	1.006	611526	613526
0.31	611876	—	0.74	611915	—	1.007	611527	613527
0.32	611877	—	0.75	611916	—	1.008	611528	613528
0.33	611878	—	0.76	611917	—	1.009	611529	613529
0.34	611879	—	0.77	611918	—	1.01	611561	613561
0.35	611826	—	0.78	611919	—	1.02	611562	613562
0.36	611880	—	0.79	611920	—	1.03	611563	613563
0.37	611881	—	0.8	611921	—	1.04	611564	613564
0.38	611882	—	0.81	611922	—	1.05	611565	613565
0.39	611883	—	0.82	611923	—	1.06	611566	613566
0.4	611827	—	0.83	611924	—	1.07	611567	613567
0.41	611884	—	0.84	611925	—	1.08	611568	613568
0.42	611885	—	0.85	611926	—	1.09	611569	613569
0.43	611886	—	0.86	611927	—	1.1	611570	613570
0.44	611887	—	0.87	611928	—	1.11	611571	613571
0.45	611828	—	0.88	611929	—	1.12	611572	613572
0.46	611888	—	0.89	611930	—	1.13	611573	613573
0.47	611889	—	0.9	611931	—	1.14	611574	613574
0.48	611890	—	0.91	611932	—	1.15	611575	613575
0.49	611891	—	0.92	611933	—	1.16	611576	613576
0.5	611506	613506	0.93	611934	—	1.17	611577	613577
0.51	611892	—	0.94	611935	—	1.18	611578	613578
0.52	611893	—	0.95	611936	—	1.19	611579	613579

Length (mm)	Order No.		Length (mm)	Order No.		Length (mm)	Order No.	
	Steel	CERA		Steel	CERA		Steel	CERA
1.2	611580	613580	2.17	611717	—	13	611623	613623
1.21	611581	613581	2.18	611718	—	13.5	611653	613653
1.22	611582	613582	2.19	611719	—	14	611624	613624
1.23	611583	613583	2.2	611720	—	14.5	611654	613654
1.24	611584	613584	2.21	611721	—	15	611625	613625
1.25	611585	613585	2.22	611722	—	15.5	611655	613655
1.26	611586	613586	2.23	611723	—	16	611626	613626
1.27	611587	613587	2.24	611724	—	16.5	611656	613656
1.28	611588	613588	2.25	611725	—	17	611627	613627
1.29	611589	613589	2.26	611726	—	17.5	611657	613657
1.3	611590	613590	2.27	611727	—	17.6	611854	613854
1.31	611591	613591	2.28	611728	—	18	611628	613628
1.32	611592	613592	2.29	611729	—	18.5	611658	613658
1.33	611593	613593	2.3	611730	—	19	611629	613629
1.34	611594	613594	2.31	611731	—	19.5	611659	613659
1.35	611595	613595	2.32	611732	—	20	611672	613672
1.36	611596	613596	2.33	611733	—	20.2	611855	613855
1.37	611597	613597	2.34	611734	—	20.5	611660	613660
1.38	611598	613598	2.35	611735	—	21	611631	613631
1.39	611599	613599	2.36	611736	—	21.5	611661	613661
1.4	611600	613600	2.37	611737	—	22	611632	613632
1.41	611601	613601	2.38	611738	—	22.5	611662	613662
1.42	611602	613602	2.39	611739	—	22.8	611856	613856
1.43	611603	613603	2.4	611740	—	23	611633	613633
1.44	611604	613604	2.41	611741	—	23.5	611663	613663
1.45	611605	613605	2.42	611742	—	24	611634	613634
1.46	611606	613606	2.43	611743	—	24.5	611664	613664
1.47	611607	613607	2.44	611744	—	25	611635	613635
1.48	611608	613608	2.45	611745	—	25.25	611754	613754
1.49	611609	613609	2.46	611746	—	30	611673	613673
1.5	611641	613641	2.47	611747	—	35	611755	613755
1.6	611516	613516	2.48	611748	—	40	611674	613674
1.7	611517	613517	2.49	611749	—	41.3	611857	613857
1.8	611518	613518	2.5	611642	613642	45	611756	613756
1.9	611519	613519	2.6	611750	—	50	611675	613675
2	611612	613612	2.7	611751	—	60	611676	613676
2.0005	611690	—	2.8	611752	—	70	611677	613677
2.001	611691	—	2.9	611753	—	75	611801	613801
2.002	611692	—	3	611613	613613	80	611678	613678
2.003	611693	—	3.5	611643	613643	90	611679	613679
2.004	611694	—	4	611614	613614	100	611681	613681
2.005	611695	—	4.5	611644	613644	125	611802	613802
2.006	611696	—	5	611615	613615	131.4	611858	613858
2.007	611697	—	5.1	611850	613850	150	611803	613803
2.008	611698	—	5.5	611645	613645	175	611804	613804
2.009	611699	—	6	611616	613616	200	611682	613682
2.01	611701	—	6.5	611646	613646	250	611805	613805
2.02	611702	—	7	611617	613617	300	611683	613683
2.03	611703	—	7.5	611647	613647	400	611684	613684
2.04	611704	—	7.7	611851	613851	500	611685	613685
2.05	611705	—	8	611618	613618	600	611840	—
2.06	611706	—	8.5	611648	613648	700	611841	—
2.07	611707	—	9	611619	613619	750	611842	—
2.08	611708	—	9.5	611649	613649	800	611843	—
2.09	611709	—	10	611671	613671	900	611844	—
2.1	611710	—	10.3	611852	613852	1000	611845	—
2.11	611711	—	10.5	611650	613650			
2.12	611712	—	11	611621	613621			
2.13	611713	—	11.5	611651	613651			
2.14	611714	—	12	611622	613622			
2.15	611715	—	12.5	611652	613652			
2.16	611716	—	12.9	611853	613853			

Metric Wear Block	
Length (mm)	Order No.
	Tungsten carbide
1	612611
2	612612

## DIMENSIONS

Unit: mm

Nominal length:  
0.1mm - 5.5mm

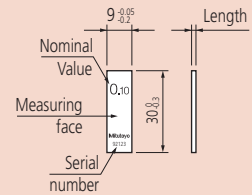

Nominal length:  
6mm - 10mm

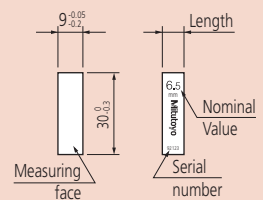

Nominal length:  
10.3mm - 100mm

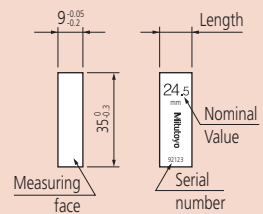

Nominal length 125mm - 1000mm

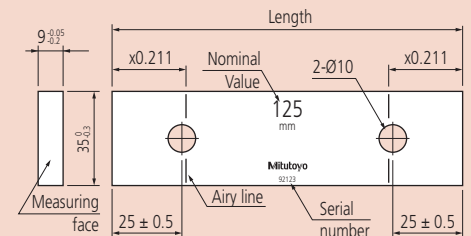

## Suffix Number for Selecting Standard and Certificate Provided

ASME	Grade	Steel, CERA
	K	-516**
	00	-521*
	0	-531*
	AS-1	-541*
	AS-2	-551*

\* provided with Inspection Certificate  
 \*\* provided with Calibration Certificate and Inspection Certificate

Example: 611310-521  
 .1" gage block in grade 00.

We make custom length gage block length:  
 .004 - 20"



Inspection Certificate

## DIMENSIONS

Unit: Inch

Nominal length:  
 .004 - .25"

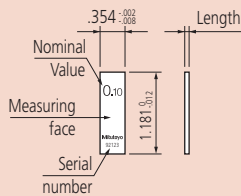

Nominal length:  
 .3 - 4"

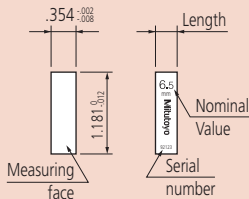

Nominal length:  
 .45 - 4"

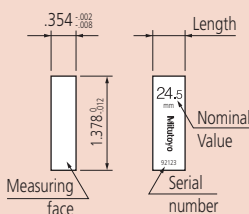

Nominal length 5 - 20"

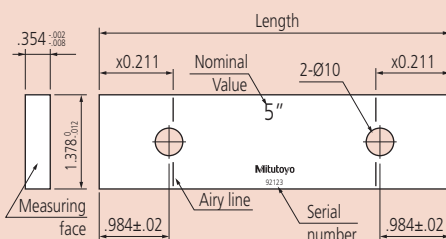

# Individual Inch Rectangular Gage Block

## SPECIFICATIONS

### Inch Block

Length (inch)	Order No.	
	Steel	CERA
.004	611304	—
.005	611305	—
.006	611306	—
.007	611307	—
.008	611308	—
.009	611309	—
.01	611310	—
.011	611311	—
.012	611312	—
.013	611313	—
.014	611314	—
.015	611315	—
.016	611316	—
.017	611317	—
.018	611318	—
.019	611319	—
.02	611320	—
.02005	611240	—
.0201	611231	—
.0202	611232	—
.0203	611233	—
.0204	611234	—
.0205	611235	—
.0206	611236	—
.0207	611237	—
.0208	611238	—
.0209	611239	—
.021	611321	—
.022	611322	—
.023	611323	—
.024	611324	—
.025	611325	—
.026	611326	—
.027	611327	—
.028	611328	—
.029	611329	—
.03	611330	—
.031	611331	—
.03125 (1/32)	611101	613103
.032	611332	—
.033	611333	—
.034	611334	—
.035	611335	—
.036	611336	—
.037	611337	—
.038	611338	—
.039	611339	—
.04	611340	—
.041	611341	—
.042	611342	—
.043	611343	—
.044	611344	—
.045	611345	—
.046	611346	—
.046875 (3/64)	611102	613104
.047	611347	—
.048	611348	—
.049	611349	—
.05	611105	613105

Length (inch)	Order No.	
	Steel	CERA
.06	611106	—
.0625	611303	613303
.07	611107	—
.078125 (5/64)	611103	613100
.08	611108	—
.09	611109	—
.09375 (3/32)	611104	613101
.1	611191	613191
.100025	611111	613110
.10005	611135	613135
.100075	611121	613111
.1001	611121	613121
.1002	611122	613122
.1003	611123	613123
.1004	611124	613124
.1005	611125	613125
.1006	611126	613126
.1007	611127	613127
.1008	611128	613128
.1009	611129	613129
.101	611141	613141
.102	611142	613142
.103	611143	613143
.104	611144	613144
.105	611145	613145
.106	611146	613146
.107	611147	613147
.108	611148	613148
.109	611149	613149
.109375 (7/64)	611110	613102
.11	611150	613150
.111	611151	613151
.112	611152	613152
.113	611153	613153
.114	611154	613154
.115	611155	613155
.116	611156	613156
.117	611157	613157
.118	611158	613158
.119	611159	613159
.12	611160	613160
.121	611161	613161
.122	611162	613162
.123	611163	613163
.124	611164	613164
.125	611165	613165
.126	611166	613166
.127	611167	613167
.128	611168	613168
.129	611169	613169
.13	611170	613170
.131	611171	613171
.132	611172	613172
.133	611173	613173
.134	611174	613174
.135	611175	613175
.136	611176	613176
.137	611177	613177
.138	611178	613178

Length (inch)	Order No.	
	Steel	CERA
.139	611179	613179
.14	611180	613180
.141	611181	613181
.142	611182	613182
.143	611183	613183
.144	611184	613184
.145	611185	613185
.146	611186	613186
.147	611187	613187
.148	611188	613188
.149	611189	613189
.15	611115	613115
.16	611116	613116
.17	611117	613117
.18	611118	613118
.19	611119	613119
.2	611192	613192
.21	611221	613221
.25	611212	613212
.3	611193	613193
.315	611209	613209
.35	611213	613213
.375 (3/8)	611113	613112
.4	611194	613194
.420	611210	613210
.45	611214	613214
.5	611195	613195
.55	611215	613215
.6	611196	613196
.605	611211	613211
.65	611216	613216
.7	611197	613197
.710	611220	613220
.75	611217	613217
.8	611198	613198
.815	611226	613226
.85	611218	613218
.9	611199	613199
.920	611227	613227
.95	611219	613219
1	611201	613201
2	611202	613202
3	611203	613203
4	611204	613204
5	611205	613205
6	611206	613206
7	611207	613207
8	611208	613208
10	611222	613222
12	611223	613223
16	611224	613224
20	611225	613225

### Inch Wear Block

Length (inch)	Order No.
	Tungsten carbide
.05	612105
.1	612191



# Rectangular Gage Block with CTE

## Gage Blocks with Thermal Expansion Coefficient Data

### FEATURES

- Mitutoyo offers top-level gage blocks (steel and ceramic) which are superior to the K class blocks, with their quality supported by Mitutoyo's best technologies.
- Comes with a highly accurate thermal expansion coefficient measured with a high accuracy double-faced interferometer (DFI).
- The high accuracy gage block interferometer (GBI) guarantees a high dimensional accuracy.
- Mitutoyo offers rectangular gage blocks, having nominal values from 100 to 500mm Grade: K class in ASME  
 Uncertainty of thermal expansion coefficient:  $0.035 \times 10^{-6}/K$  ( $k = 2$ )  
 Uncertainty of dimension measurement: 30nm ( $k = 2$ ), for 100mm block

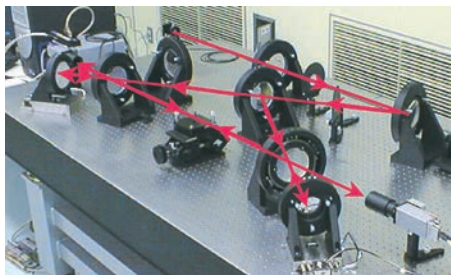

double-faced interferometer (DFI)

### SPECIFICATIONS

Metric Block with CTE		
Length (mm)	Order No. Steel	Order No. CERA
100	611681-51B	613681-51B
125	611802-51B	613802-51B
150	611803-51B	613803-51B
175	611804-51B	613804-51B
200	611682-51B	613682-51B
250	611805-51B	613805-51B
300	611683-51B	613683-51B
400	611684-51B	613684-51B
500	611685-51B	613685-51B

Inch Block with CTE		
Length (inch)	Order No. Steel	Order No. CERA
4	611204-51B	613204-51B
5	611205-51B	613205-51B
6	611206-51B	613206-51B
7	611207-51B	613207-51B
8	611208-51B	613208-51B
10	611222-51B	613222-51B
12	611223-51B	613223-51B
16	611224-51B	613224-51B
20	611225-51B	613225-51B



\* Suffix Number for Selecting Standard and Certificate Provided

ASME	
Grade K	Steel, CERA
	-51B

-51B: provided with JCSS Calibration Certificate and Inspection Certificate

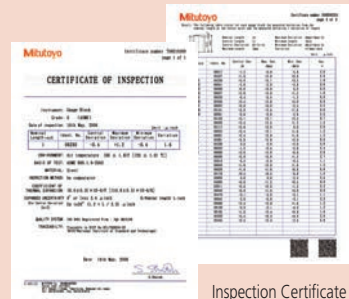

Inspection Certificate

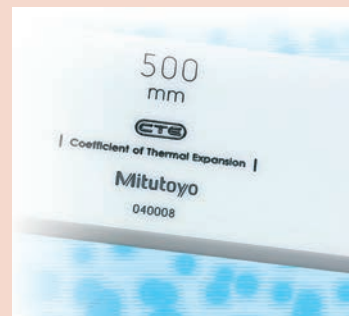

# Rectangular Gage Block Accessories

## SERIES 516 – For Gage Blocks over 100mm

Specially designed for the long gage blocks over 100mm which have two holes on the body for coupling.

### SPECIFICATIONS

#### Accessories for gage blocks over 100mm

Order No. 516-605	Included in set
1 pc.	Holder A (619031)
1 pc.	Holder B (619032)
1 pc.	Holder C (619033)
1 pc.	Holder D (619034)
1 pc.	Holder E (619035)
3 pcs.	Adaptor (619036)
1 pc.	Holder base 35mm (619009)
2 pcs.	Half round jaw 12mm (619013)
2 pcs.	Plain jaw (619018)
1 pc.	Scriber point (619019)

Note: These accessories can be used for inch rectangular gage blocks.



516-605

#### Holder A: 619031

Used for coupling two long gage blocks.

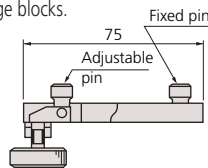

#### Holder B and C:

Used for coupling two long gage blocks together with other gage blocks up to 35mm (Holder B) or 140mm (Holder C). Also used for attaching jaws with two adaptors.

	Order No.	R (max.)	L
Holder B	619032	90mm	126mm
Holder C	619033	200mm	236mm

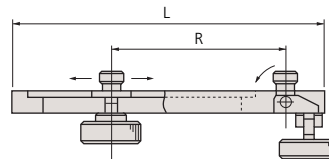

#### Holder D: 619034

Used for attaching to the holder base.

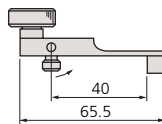

#### Holder E: 619035

Used for attaching to the holder base together with other gage blocks up to 125mm. Used for attaching jaws with one adaptor.

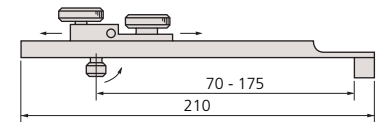

#### Holder base: 619009

Adaptor: 619036

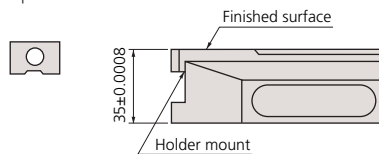

#### Half round jaw: 619013

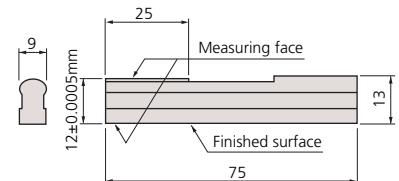

#### Plain jaw: 619018

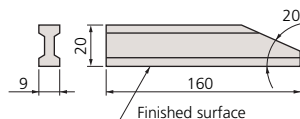

#### Scriber point: 619019

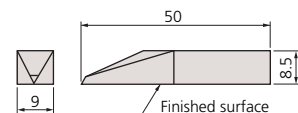

# Rectangular Gage Block Accessories

## SERIES 516

To expand the variety of rectangular gage block (steel and CERA) applications, Mitutoyo offers the gage block accessories set. By assembling the items in the set, you can easily and quickly build up a precision measuring instrument.



516-601



516-602

## SPECIFICATIONS

### Assortment of Accessories

Order No.	Accessories	Metric Set Order No.		Accessory (s) included in a set
		516-601	516-602	
619002	Holder 60mm		•	1 pc.
619003	Holder 100mm	•	•	1 pc.
619004	Holder 160mm	•	•	1 pc.
619005	Holder 250mm	•	•	1 pc.
619009	Holder Base 35mm	•	•	1 pc.
619010	Half round jaw 2mm	•	•	2 pcs.
619011	Half round jaw 5mm	•	•	2 pcs.
619012	Half round jaw 8mm	•	•	2 pcs.
619013	Half round jaw 12mm	•	•	2 pcs.
619014	Half round jaw 20mm	•	•	2 pcs.
619018	Plain jaw 160mm	•	•	2 pcs.
619019	Scriber point	•	•	1 pc.
619020	Center point	•	•	1 pc.
619021	Tram point	•	•	2 pcs.
619022	Triangular straightness edge 100mm	•	•	1 pc.
619023	Triangular straight edge 160mm	•	•	1 pc.
	<b>Total Qty. in set</b>	22 pcs.	14 pcs.	

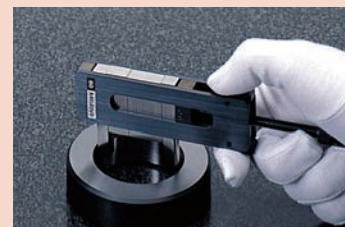

# Rectangular Gage Block Accessories

Holder:  
Used as a clamp if using plain jaws, scriber point, etc.

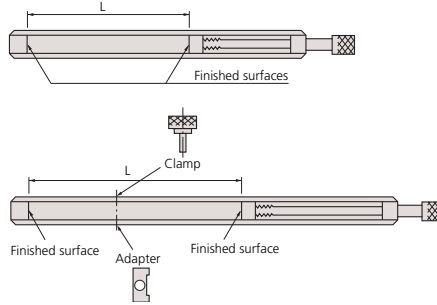

Order No.	L
619002	15 - 61mm
619003	4 - 106mm
619004	62 - 165mm
619005	153 - 256mm

Holder base 35mm: **619009**  
Measures a height on the surface plate and scribes a workpiece if used with the holder.

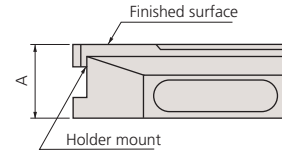

Order No.	A
619009	35±0.005mm

Scriber point: **619019**  
Scribes a workpiece if used with the holder and holder base.

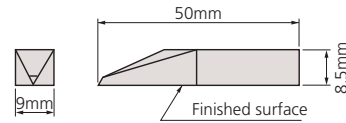

Center point: **619020**  
Scribes a workpiece if used with the holder and holder base.

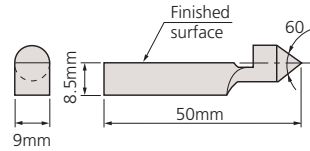

Tram point: **619021**  
Inspects the scale of the height gage, etc., if used with the holder and holder base.

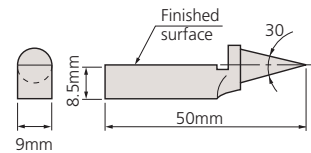

Plain jaw: **619018**  
Measures an outside or inside diameter if used with a pair of jaws and the holder.

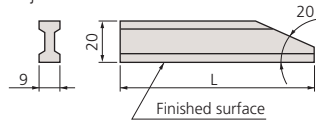

Order No.	L
619018	160mm

Triangular straight edge: Measures parallelism.

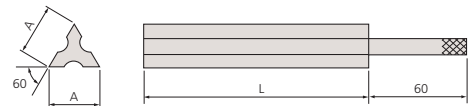

Order No.	L
619022	100mm
619023	160mm

Half round jaw:  
Measures an outside or inside diameter if used with a pair of jaws and the holder.

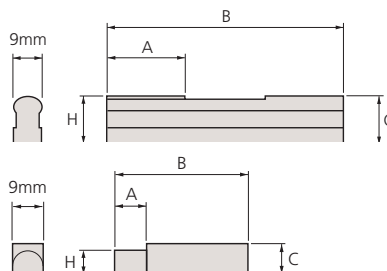

Order No.	H	A	B	C
619010	2±0.0005mm	6mm	40mm	8mm
619011	5±0.0005mm	6mm	50mm	8mm
619012	8±0.0005mm	12mm	60mm	8mm
619013	12±0.0005mm	25mm	75mm	13mm
619014	20±0.0005mm	25mm	125mm	20.5mm

# Metric Square Gage Block Set

## SERIES 516 — Metric Block Set, Long Block Set, Wear Block Set

A Square Gage Block can retain stable orientation both longitudinally and laterally. A wide range of application measurements can be made, including cutting tool positioning, angle measurement with a sine bar, taper measurement with a roller, and inspection of depth micrometers.



Steel 32-block set



Steel 76-block set



Steel 103-block set



Steel 112-block set

## SPECIFICATIONS

### Metric Block Set

Blocks per set	Order No.		Grade	Blocks included in set		
	Steel	CERA		Size	Step	Qty.
112	516-437-26	—	00	1.005	—	1
	516-438-26	—	0	1.001 - 1.009	0.001	9
	516-439-26	—	AS-1	1.01 - 1.49	0.01	49
	516-440-26	—	AS-2	0.5 - 24.5	0.5	49
	—	—	—	25 - 100	25	4
103	516-441-26	—	00	1.005	—	1
	516-442-26	—	0	1.01 - 1.49	0.01	49
	516-443-26	—	AS-1	0.5 - 24.5	0.5	49
	516-444-26	—	AS-2	25 - 100	25	4
	—	—	—	—	—	—
76	516-449-26	—	00	1.005	—	1
	516-450-26	—	0	1.01 - 1.49	0.01	49
	516-451-26	—	AS-1	0.5 - 9.5	0.5	19
	516-452-26	—	AS-2	10 - 40	10	4
	—	—	—	50 - 100	25	3
47	516-457-26	—	00	1.005	—	1
	516-458-26	—	0	1.01 - 1.09	0.01	9
	516-459-26	—	AS-1	1.1 - 1.9	0.1	9
	516-460-26	—	AS-2	1 - 24	1	24
	—	—	—	25 - 100	25	4
32	516-465-26	—	00	1.005	—	1
	516-466-26	—	0	1.01 - 1.09	0.01	9
	516-467-26	—	AS-1	1.1 - 1.9	0.1	9
	516-468-26	—	AS-2	1 - 9	1	9
	—	—	—	10 - 30	10	3
—	—	—	60	—	1	

### Metric Long Block Set

Blocks per set	Order No.		Grade	Blocks included in set		
	Steel	CERA		Size	Step	Qty.
8	516-751-26	—	00	125, 150, 175	25	3
	516-752-26	—	0	200, 250	50	2
	516-753-26	—	AS-1	300, 400, 500	100	3
	516-754-26	—	AS-2	—	—	—

### Metric Wear Block Set

Blocks per set	Order No.		Grade	Blocks included in set		
	Carbide	CERA		Size	Step	Qty.
2	516-820-26	—	0	1	—	2
	516-821-26	—	AS-1	—	—	—
2	516-822-26	—	0	2	—	2
	516-823-26	—	AS-1	—	—	—

Provided with Inspection Certificate

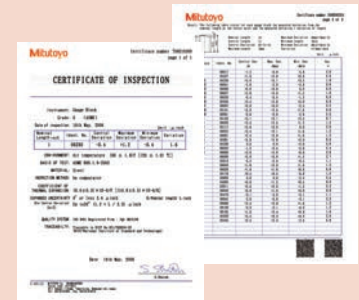



Provided with Inspection Certificate

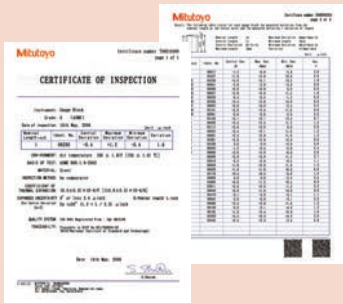

# Inch Square Gage Block Set

**SERIES 516 — Inch Block Set, Long Block Set, Wear Block Set**

## SPECIFICATIONS

### Inch Block Set

Blocks per set	Order No.		Grade	Blocks included in set		
	Steel	CERA		Size	Step	Qty.
<b>81</b>	516-401-26	516-201-26	00	.1001 - .1009	.0001	9
	516-402-26	516-202-26	0	.101 - .149	.001	49
	516-403-26	516-203-26	AS-1	.05 - .95	.05	19
	516-404-26	516-204-26	AS-2	1 - 4	1	4
<b>36</b>	516-421-26	516-221-26	00	.05"		1
	516-422-26	516-222-26	0	.1001 - .1009	.0001	10
	516-423-26	516-223-26	AS-1	.101 - .109	.001	9
	516-424-26	516-224-26	AS-2	.11 - .19	.01	9
				.1 - .5	.1	5
<b>28</b>	516-417-26	—	00	.02005"		1
	516-418-26	—	0	.0201 - .0209"	.0001	9
	516-419-26	—	AS-1	.021 - .029"	.001	9
	516-420-26	—	AS-2	.021 - .029"	.01	9
				.10 - .090"		



Steel 47-block set

### Inch Long Block Set

Blocks per set	Order No.		Grade	Blocks included in set		
	Steel	CERA		Size	Step	Qty.
<b>8</b>	516-762-26	—	0	5 - 7	1	3
	516-763-26	—	AS-1	8, 10, 12	2	3
				16, 20	4	2



Steel 8-block set

### Inch Wear Block Set

Blocks per set	Order No.		Grade	Blocks included in set		
	Carbide	CERA		Size	Step	Qty.
<b>2</b>	516-824-26	516-846-26	0	.05	—	2
	516-825-26	516-847-26	AS-1			
<b>2</b>	516-826-26	516-844-26	0	.1	—	2
	516-827-26	516-845-26	AS-1			



Carbide 2-block set

### 92 pcs. Gage Blocks with accessories set in wooden box

Blocks in set	Order No.	Grade	Blocks included in set			Individual No.	Description	Qty.
			Size	Step	Qty.			
<b>92</b>	516-405-26	0	.0625	.0001	1	619052	Plain Jaw .500"	2
			.078125		1	619051	Half round jaw .250"	2
			.09375		1	619055	Holder base .500"	1
			.100025		1	619057	Flat head screw 1 1/4"	2
			.10005		1	619058	Flat head screw 5/8"	2
			.100075		1	619056	Stud	2
			.109375		1	619066	Knurled head screw	2
			.1001 - .1009		9	619059	Slotted head nut	2
			.101 - .149		49	619062	Tie rod 3"	1
			.05 - .95		4	619063	Tie rod 2 1/4"	1
			.16 - .19		19	619064	Tie rod 1 1/2"	1
			1 4		4	619065	3/4"	1

# Individual Metric Square Gage Block



## SPECIFICATIONS

### Metric Block

Length (mm)	Order No.		Length (mm)	Order No.		Length (mm)	Order No.	
	Steel	CERA		Steel	CERA		Steel	CERA
0.5	614506	—	1.33	614593	—	13	614623	—
1	614611	—	1.34	614594	—	13.5	614653	—
1.0005	614520	—	1.35	614595	—	14	614624	—
1.001	614521	—	1.36	614596	—	14.5	614654	—
1.002	614522	—	1.37	614597	—	15	614625	—
1.003	614523	—	1.38	614598	—	15.5	614655	—
1.004	614524	—	1.39	614599	—	16	614626	—
1.005	614525	—	1.4	614600	—	16.5	614656	—
1.006	614526	—	1.41	614601	—	17	614627	—
1.007	614527	—	1.42	614602	—	17.5	614657	—
1.008	614528	—	1.43	614603	—	18	614628	—
1.009	614529	—	1.44	614604	—	18.5	614658	—
1.01	614561	—	1.45	614605	—	19	614629	—
1.02	614562	—	1.46	614606	—	19.5	614659	—
1.03	614563	—	1.47	614607	—	20	614672	—
1.04	614564	—	1.48	614608	—	20.5	614660	—
1.05	614565	—	1.49	614609	—	21	614631	—
1.06	614566	—	1.5	614641	—	21.5	614661	—
1.07	614567	—	1.6	614516	—	22	614632	—
1.08	614568	—	1.7	614517	—	22.5	614662	—
1.09	614569	—	1.8	614518	—	23	614633	—
1.1	614570	—	1.9	614519	—	23.5	614663	—
1.11	614571	—	2	614612	—	24	614634	—
1.12	614572	—	2.5	614642	—	24.5	614664	—
1.13	614573	—	3	614613	—	25	614635	—
1.14	614574	—	3.5	614643	—	30	614673	—
1.15	614575	—	4	614614	—	40	614674	—
1.16	614576	—	4.5	614644	—	50	614675	—
1.17	614577	—	5	614615	—	60	614676	—
1.18	614578	—	5.5	614645	—	75	614801	—
1.19	614579	—	6	614616	—	100	614681	—
1.2	614580	—	6.5	614646	—	125	614802	—
1.21	614581	—	7	614617	—	150	614803	—
1.22	614582	—	7.5	614647	—	175	614804	—
1.23	614583	—	8	614618	—	200	614682	—
1.24	614584	—	8.5	614648	—	250	614805	—
1.25	614585	—	9	614619	—	300	614683	—
1.26	614586	—	9.5	614649	—	400	614684	—
1.27	614587	—	10	614671	—	500	614685	—
1.28	614588	—	10.5	614650	—			
1.29	614589	—	11	614621	—			
1.3	614590	—	11.5	614651	—			
1.31	614591	—	12	614622	—			
1.32	614592	—	12.5	614652	—			

### Metric Wear Block

Length (mm)	Order No. Tungsten carbide
1	615611
2	615612

Suffix Number for Selecting Standard and Certificate Provided

ASME	
Grade	Steel
K	—
00	-521*
0	-531*
AS-1	-541*
AS-2	-551*

\* provided with Inspection Certificate

Example: 614611-521  
1mm gage block in grade 00.

We make custom length gage block length:  
0.5 - 500mm.



Inspection Certificate

# Individual Inch Square Gage Block

## Suffix Number for Selecting Standard and Certificate Provided

ASME	
Grade	Steel, CERA
K	—
00	-521*
0	-531*
AS-1	-541*
AS-2	-551*

\* provided with Inspection Certificate

Example: 614310-521  
.01" gage block in grade 00.

We make custom length gage block length:  
.01 - 20"



Inspection Certificate

## DIMENSIONS

Nominal length: 0.5mm - 4.5mm  
(.010" - .19")

Unit: mm

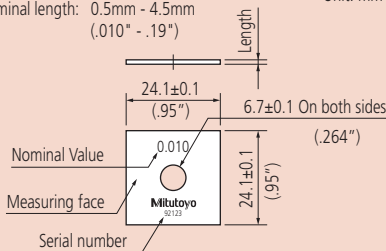

Nominal length: 5mm - 14.5mm  
(.02" - .450")

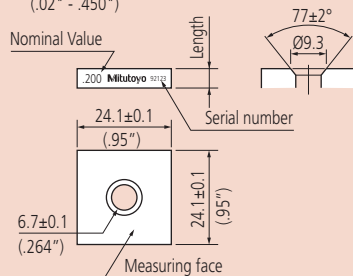

Nominal length: 15mm - 500mm  
(.500" - 20")

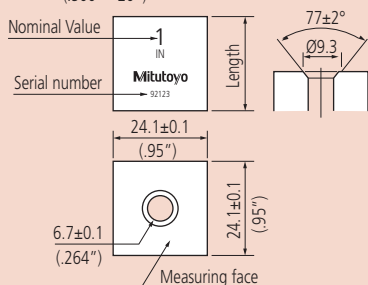

## SPECIFICATIONS

### Inch Block

Length (inch)	Order No.		Length (inch)	Order No.		Length (inch)	Order No.	
	Steel	CERA		Steel	CERA		Steel	CERA
.01	614310	—	.106	614146	616146	.25	614212	616212
.02005	614240	—	.107	614147	616147	.3	614193	616193
.0201	614231	—	.108	614148	616148	.35	614213	616213
.0202	614232	—	.109	614149	616149	.375 (3/8)	614309	—
.0203	614233	—	.109375 (7/64)	614306	—	.4	614194	616194
.0204	614234	—	.11	614150	616150	.45	614214	616214
.0205	614235	—	.111	614151	616151	.5	614195	616195
.0206	614236	—	.112	614152	616152	.55	614215	616215
.0207	614237	—	.113	614153	616153	.6	614196	616196
.0208	614238	—	.114	614154	616154	.65	614216	616216
.0209	614239	—	.115	614155	616155	.7	614197	616197
.02	614320	—	.116	614156	616156	.75	614217	616217
.021	614321	—	.117	614157	616157	.8	614198	616198
.022	614322	—	.118	614158	616158	.85	614218	616218
.023	614323	—	.119	614159	616159	.9	614199	616199
.024	614324	—	.12	614160	616160	.95	614219	616219
.025	614325	—	.121	614161	616161	1	614201	616201
.026	614326	—	.122	614162	616162	2	614202	616202
.027	614327	—	.123	614163	616163	3	614203	616203
.028	614328	—	.124	614164	616164	4	614204	616204
.029	614329	—	.125	614165	616165	5	614205	—
.03	614330	—	.126	614166	616166	6	614206	—
.03125 (1/32)	614301	—	.127	614167	616167	7	614207	—
.04	614340	—	.128	614168	616168	8	614208	—
.046875 (3/64)	614302	—	.129	614169	616169	10	614222	—
.05	614105	616105	.13	614170	616170	12	614223	—
.06	614106	—	.131	614171	616171	16	614224	—
.0625	614303	616303	.132	614172	616172	20	614225	—
.07	614107	—	.133	614173	616173			
.078125 (5/64)	614304	—	.134	614174	616174			
.08	614108	—	.135	614175	616175			
.09	614109	—	.136	614176	616176			
.09375 (3/32)	614305	—	.137	614177	616177			
.1	614191	616191	.138	614178	616178			
.100025	614307	—	.139	614179	616179			
.10005	614135	616135	.14	614180	616180			
.100075	614308	—	.141	614181	616181			
.1001	614121	616121	.142	614182	616182			
.1002	614122	616122	.143	614183	616183			
.1003	614123	616123	.144	614184	616184			
.1004	614124	616124	.145	614185	616185			
.1005	614125	616125	.146	614186	616186			
.1006	614126	616126	.147	614187	616187			
.1007	614127	616127	.148	614188	616188			
.1008	614128	616128	.149	614189	616189			
.1009	614129	616129	.15	614115	616115			
.101	614141	616141	.16	614116	616116			
.102	614142	616142	.17	614117	616117			
.103	614143	616143	.18	614118	616118			
.104	614144	616144	.19	614119	616119			
.105	614145	616145	.2	614192	616192			

### Inch Wear Block

Length (inch)	Order No. Tungsten carbide
.05	615105
.1	615191

# Square Gage Block Accessories

## SERIES 516

To expand the variety of Square Gage Block applications, Mitutoyo offers the Gage Block Accessories Set. By assembling the items in the set, you can easily and quickly build up a precision measuring instrument.

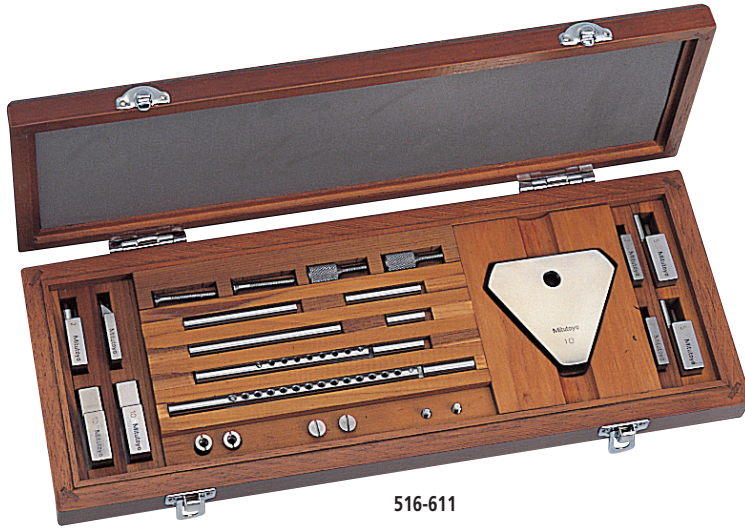

516-611

### SPECIFICATIONS

Metric	
Order No. 516-611	Included in set
2 pcs.	Half round jaw 2mm (619070)
2 pcs.	Half round jaw 5mm (619071)
2 pcs.	Plain jaw (619072)
1 pc.	Center point (619073)
1 pc.	Scriber point (619054)
1 pc.	Block base (619074)
2 pcs.	Flat head screw 1-1/4" (619057)
2 pcs.	Flat head screw 5/8" (619058)
2 pcs.	Slotted head nut (619059)
2 pcs.	Adjustable tie rod 6" (619060)
2 pcs.	Adjustable tie rod 4-1/2" (619061)
1 pc.	Tie rod 3" (619062)
1 pc.	Tie rod 2-1/4" (619063)
1 pc.	Tie rod 1-1/2" (619064)
1 pc.	Tie rod 3/4" (619065)
2 pcs.	Stud (619056)
2 pcs.	Knurled head screw (619066)

Inch	
Order No. 516-612	Included in set
2 pcs.	Half round jaw .125" (619050)
2 pcs.	Half round jaw .25" (619051)
2 pcs.	Plain jaw (619052)
1 pc.	Center point (619053)
1 pc.	Scriber point (619054)
1 pc.	Block base (619055)
2 pcs.	Flat head screw 1-1/4" (619057)
2 pcs.	Flat head screw 5/8" (619058)
2 pcs.	Slotted head nut (619059)
2 pcs.	Adjustable tie rod 6" (619060)
2 pcs.	Adjustable tie rod 4-1/2" (619061)
1 pc.	Tie rod 3" (619062)
1 pc.	Tie rod 2-1/4" (619063)
1 pc.	Tie rod 1-1/2" (619064)
1 pc.	Tie rod 3/4" (619065)
2 pcs.	Stud (619056)
2 pcs.	Knurled head screw (619066)

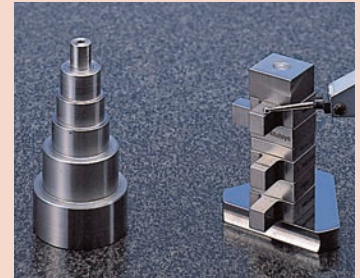
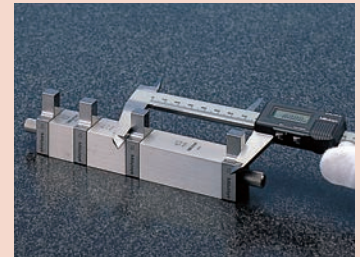

Half round jaw:  
Used to measure an inside or outside diameter.

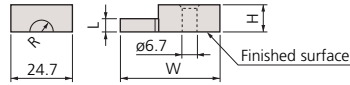

Order No.	R	L	W	H
619070	1.95mm	2mm	33.6mm	5.3mm
619071	4.95mm	5mm	39.9mm	10.3mm
619050	.123"	.125"	33.6mm	5.3mm
619051	.248"	.25"	39.9mm	10.3mm

Plain jaw: 619072 (10mm), 619052 (.5")  
Used to measure an inside or outside diameter.

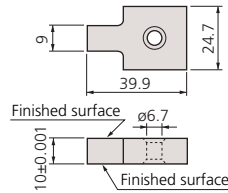

Center point: 619073 (2mm), 619053 (.1")  
Used to scribe a workpiece.

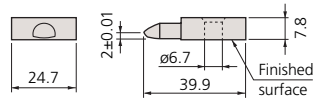

Scriber point: 619054  
Used to scribe a workpiece.

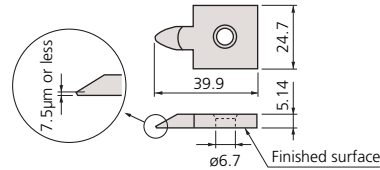

Base: 619074 (10mm), 619055 (.5")  
Used as clamps by inserting them into the center hole of a square gage block.

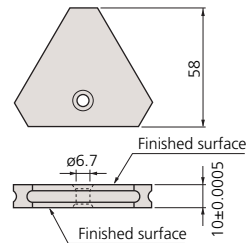

Stud: 619056

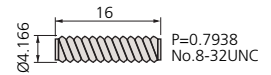

Flat head screw

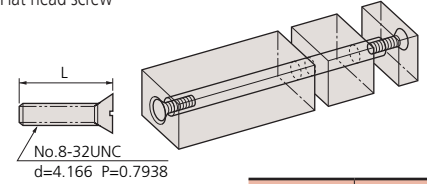

Order No.	L
619057	31.6mm
619058	15.8mm

Slotted head nut: 619059

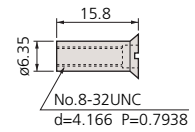

Knurled head screw: 619066

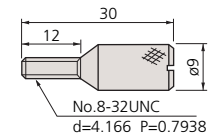

Tie rod

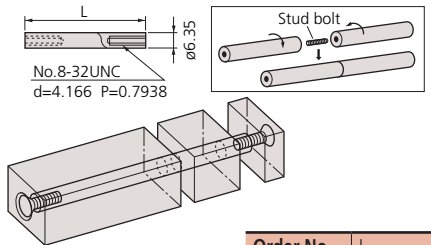

Order No.	L
619065	19mm
619064	38mm
619063	57mm
619062	76mm

Adjustable tie rod

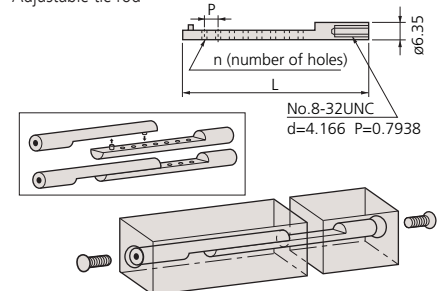

Order No.	L	P	n
619060	124.5mm	6.35mm	14
619061	86.5mm	6.35mm	8

# Ceraston

## Accessory for Gage Blocks

### FEATURES

- Alumina-ceramic grinding stone for removing burrs from hard materials such as ceramics that ordinary grinding stones cannot handle.
- Can be used both for steel gage blocks and CERA Blocks.

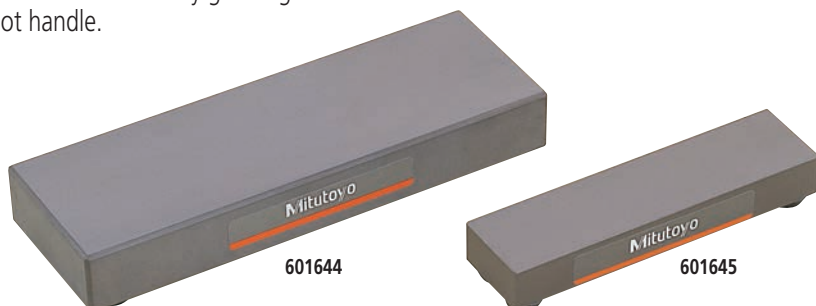

### SPECIFICATIONS

Order No.	Dimensions (W x D x H)	Mass
601645	100 x 25 x 12mm	110g
601644	150 x 50 x 20mm	530g

# Maintenance Kit for Gage Block

## SERIES 516

### FEATURES

- Includes all necessary maintenance tools for daily care and storage of gage blocks.
- Supplied in a fitted wooden case for portable use.



### SPECIFICATIONS

Order No.	Assortment of tools and accessories
516-650E	Ceraston (601645): Used for removing burrs on the measuring surface
	Optical flat (600003): Used for checking whether burrs exist.
	Tweezers (600004): Used for handling thin gage blocks.
	Blower brush (600005): Used for blowing out dust on the measuring surface.
	Cleaning paper (600006): Used for wiping off rust preventive oil and contamination.
	Artificial leather mat (600007): Used as a gage block mat.
	Reagent bottle (600008): Bottle of wiping solution (100mL)
	Gloves



### Removing burrs

- (1) Wipe any dust and oil films from the gage block and the Ceraston (or Arkansas stone) using a solvent.
- (2) Place the gage block on the Ceraston so that the measuring face that has burrs is on the abrasive surface of the stone. While applying light pressure, move the gage block to and fro about ten times (Fig. 1). Use a block rubber for thin gage blocks to apply even pressure (Fig. 2).
- (3) Check the measuring face for burrs with an optical flat. If the burrs have not been removed, repeat step (2). If burrs are too large, they may not be removed with a grinding stone. If so, discard the gage block.

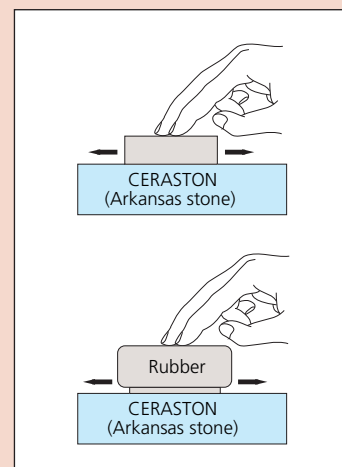

Note: The abrasive surface of a Ceraston must be made flat by lapping it from time to time. After lapping the Ceraston, the lapping powder must be completely removed from the surface to prevent the surface of the gage block from being scratched. Mitutoyo does not handle the Arkansas stone.



# Step Master

**SERIES 516**

## FEATURES

Step master is a master gage used for the z-axis (vertical direction) calibration of optical instruments.

- Each adjacent step is measured down to 0.01μm by using an interferometer within ±0.20μm allowance.
- Steel and ceramic types are available.

## Dimension

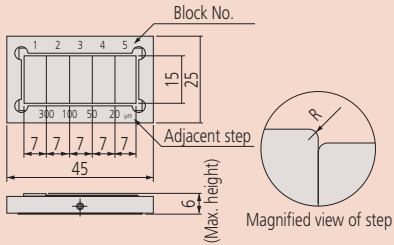

**516-498**  
Ceramic type



**516-199**  
Steel type



## SPECIFICATIONS

### Metric

Order No.	Step value between adjacent blocks				Remarks
	No. 1 - No. 2	No. 2 - No. 3	No. 3 - No. 4	No. 4 - No. 5	
<b>516-198</b>	10μm	5μm	2μm	1μm	Steel type
<b>516-199</b>	300μm	100μm	50μm	20μm	Steel type
<b>516-498</b>	10μm	5μm	2μm	1μm	Ceramic type
<b>516-499</b>	300μm	100μm	50μm	20μm	Ceramic type

# Made-to-order Block & Reference

## Available Dimension

Nominal size: .004 to 20" / 0.1 to 1000mm (steel)  
.1 to 20" / 0.5 to 500mm (ceramic)

Nominal pitch: 0.0005mm (up to 100mm)  
0.001mm (over 100mm)

Minimum section dimension:  
Approx. .24 x .24" / 6 x 6mm

Maximum section dimension:  
Approx. 5.5 x 5.5" / 140 x 140mm (steel)  
Approx. 6.3" Dia. / ø160mm (steel, cylindrical)  
Approx. 3.94 x 1.97" / 100 x 50mm (ceramic)  
Approx. .24" Dia. / ø60mm (ceramic, cylindrical)

Accuracy: Gage Block Grade level

Special materials of low expansion glass and low expansion ceramic are available.

## FEATURES

- Mitutoyo can provide Gage Blocks and reference gages to you size and design.

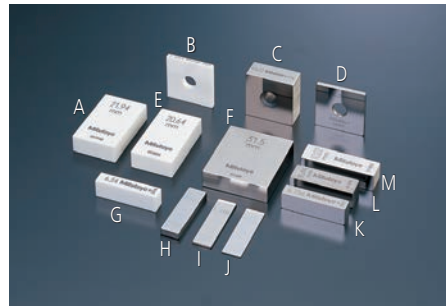

- A: Ceramic rectangular gage block (21.94mm)
- B: Ceramic square gage block (2.1005mm)
- C: Steel square gage block (10.72mm)
- D: Steel square gage block (2.2065mm)
- E: Ceramic rectangular gage block (20.64mm)
- F: Steel rectangular gage block (31.5mm)
- G: Ceramic rectangular gage block (6.34mm)
- H: Steel rectangular gage block (3.603mm)
- I: Steel rectangular gage block (1.1505mm)
- J: Steel rectangular gage block (0.555mm)
- K: Steel rectangular gage block (6.156mm)
- L: Steel rectangular gage block (9.694mm)
- M: Steel rectangular gage block (10.02mm)

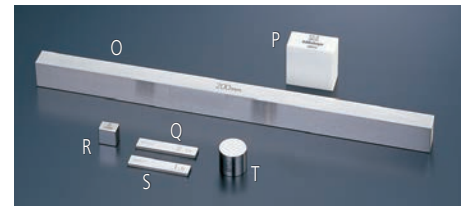

- O: Steel Long rectangular block (15 x 10 x 200mm)
- P: Ceramic square block (24.1 x 24.1 x 12.3mm)
- Q: Steel thin rectangular block (30 x 6 x 1.9mm)
- R: Steel square block (9 x 9 x 6mm)
- S: Steel thin rectangular block (30 x 6 x 2.1mm)
- T: Steel cylindrical block (ø13.08 x 12mm)



- U: Cylindrical reference block for depth micrometer (ø60 x 150mm)
- V: Ceramic reference plate (50 x 50 x 50mm, flatness 0.3μm)
- W: Ceramic stepped block (30 x 18 x 5mm, step: 0.15mm)

# Gage Block Comparator GBCD-250

**SERIES 565 — Manual Type Comparator with Dual Gage Heads**

## FEATURES

- Gage blocks between 0.1mm and 250mm can be easily compared with the standard gage block on the GBCD-250.
- The differential dual gaging heads assure the operator of a high-accuracy measurement with ease of use.

## SPECIFICATIONS

Inch/Metric	
Model No.	GBCD-250
Order No.	565-150A
Range	0.1mm - 250mm / .004 - 10"
Resolution	0.00001mm (0.01 $\mu$ m) / .000001"
Accuracy in narrow range (20°C)	$\pm(0.03+0.3L/1000)\mu\text{m}^*$ L = Gage block length (mm)
Measuring units	Laser Hologage (upper), Mu-checker (lower)
Operating condition	Temperature: 20°C $\pm$ 1°C Humidity: 58%RH $\pm$ 15%RH
Data output	Via SPC output port
Dimensions (W x D x H)	Main unit: 455 x 318 x 691mm Display unit: 345 x 397 x 187mm
Mass	Main unit: Approx. 50kg Display unit: Approx. 9kg

\*Uncertainty of measurement is 95% (not including the calibration error of the standard gage block).



## Optional Accessories

- 962723: Gage head calibration kit  
 02ASD130: Square gage block holder kit  
 02ASF040: Heat protection shield  
 02ASD100: Gage block set for accuracy inspection PC System  
 02ASG610A: GBPAK-M\*  
 \* Included: Software  
 Foot Switch (937179T)  
 MUX-10F (264-002A)  
 Connecting cable (936937)

# Gage Block Comparator GBCD-100A

**SERIES 565 — Automatic Type Comparator with Dual Gage Heads**

## SPECIFICATIONS

Model No.	GBCD-100A
Order No.	565-160A
Resolution	0.00001mm (0.01 $\mu$ m) / .000001"
Range	0.5mm - 100mm / .02 - 4"
Measuring unit	Differential (dual-head) type Mu-Checker
Accuracy in narrow range (20°C)	$\pm(0.03+0.3L/1000)\mu\text{m}^*$ L = Gage block length (mm) *Uncertainty of measurement is 95% (not including the calibration error of the standard gage block).
Measuring force	Upper gage head: 1N (100gf) Lower gage head: 0.6N (60gf)
Air requirement	400kPa (4kgf/cm <sup>2</sup> )
Operating condition	Temperature: 20°C $\pm$ 1°C Humidity: 58%RH $\pm$ 15%RH
Dimensions (W x D x H)	Main unit: 710 x 366 x 783mm Electronic unit: 160 x 410 x 382mm
Mass	Main unit: 120kg Electronic unit: 14kg



## Standard Accessories

GBPAK-A (software)

## Optional Accessories

- 962723: Gage block set for probe calibration  
 962764: Gage block holder for probe calibration  
 611615-02: 5mm gage block (glade 0) for origin setting  
 243989: Auxiliary stage (size: 360 x 253mm)  
 218-007: Work bench PC System

The GBCD-100A Automatic Gage Block Comparator is an easy-to-operate dual-head type gage block inspecting system. It automatically compares workpieces with a standard gage block and determines accuracies of such as central length, maximum length, minimum length, and parallelism through the operation of an optional personal computer.





### Technical Data

Graduation: .00001" or 0.001mm  
 Counter resolution: .001" or 0.01mm  
 Character Height: .16" / 4mm  
 Micrometer Head  
 Travel stroke: 1" or 20mm  
 Pitch: .025"/rev or 0.5mm/rev  
 Hysteresis: .00004" or 1µm  
 Provided with inspection certificate.

### Standard Accessories

Reference Block: 11mm for 515-322  
 Reference Block: .3" for 515-310, 515-311

### Optional Accessories

515-112: Auxiliary block kit for bore gage (mm)  
 515-119: Auxiliary block kit for bore gage (for 515-310)  
 515-121: Auxiliary block kit for bore gage (for 515-311)  
 \_\_\_\_\_: Riser block

### Reading

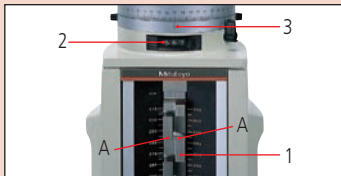

#### Height A

1. Scale 280. mm  
 2. Counter 5.67 mm  
 3. Thimble 0.000 mm

285.670 mm



# Height Master

## SERIES 515

### FEATURES

- Models with staggered arrangement of block stack have two measuring faces on the same level, one facing up and the other down (except for 515-310).
- Each Height Master is supplied with a gage block for zero-setting.
- Supplied in fitted wooden case.



515-322



515-310

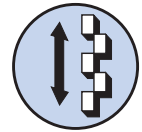

Staggered 20mm blocks (movable)



Vertical orientation



Riser block

### SPECIFICATIONS

#### Metric

Range (H)	Order No.	Block step	Graduation	Block Pitch Accuracy	Parallelism of Block	Micrometer Head Accuracy	Mass (kg)
5 < H ≤ 310mm	515-322	20mm (staggered)	0.001mm	±1.5µm	1µm	±1µm	23

#### Inch

Range (H)	Order No.	Block step	Graduation	Block Pitch Accuracy	Parallelism of Block	Micrometer Head Accuracy	Mass (kg)
.2" < H ≤ 12.2"	515-310	.5" (straight)	.00001"	±.00005"	.00004"	±.00005"	23
.2" < H ≤ 12.2"	515-311	1" (staggered)	.00001"	±.00005"	.00004"	±.00005"	23

# Digital Height Master

## SERIES 515

### FEATURES

- Standard model with a digital display, featuring all essential specifications required for versatile height standard.
- With SPC output.
- Each Height Master is supplied with a gage block for zero setting.



515-374

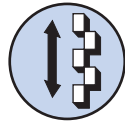

Staggered 20mm blocks (movable)



Vertical orientation



Riser block



### Technical Data

Resolution (LCD): .0001" or 0.001mm  
 Graduation: .0001" or 0.002mm  
 Character Height .21" / 5.4mm

### Micrometer Head

Travel Stroke: 1" or 20mm  
 Pitch: .025"/rev or 0.5mm/rev  
 Hysteresis: .0001" For all inch models  
 0.002mm for 300mm models  
 0.0025mm for 450 & 600mm models  
 Battery: SR44 (2 pcs.), **938882**  
 Battery life: Approx. 1.8 years under normal use

### Function

Zero-setting, Presetting, ABS/INC switching, Data hold, Data output, inch/mm conversion (on inch/metric models only)  
 Alarm: Low voltage, Counting value composition error

### Standard Accessories

Reference Block: 11mm for Metric Height Master  
 Reference Block: .6" for for Inch Height Master  
 Provided with inspection certificate.

### Optional Accessories

- 515-111:** Auxiliary block kit for bore gage (mm)
- 515-120:** Auxiliary block kit for bore gage (inch)
- : Riser block (see page E-27.)
- 959149:** SPC cable (40" / 1m)
- 959150:** SPC cable (80" / 2m)
- 050019:** Fitted Mohogany case for 12" / 300mm model
- 050059:** Fitted Mohogany case for 18" / 450mm model  
24" / 600mm model

## SPECIFICATIONS

### Metric

Range (H)	Order No.	Block step	Resolution	Block Pitch Accuracy	Parallelism	Micrometer Head Accuracy	Mass (kg)
10 < H ≤ 310mm	<b>515-374</b>	20mm (staggered)	0.001mm	±1.5µm	2µm	±2µm	9.5
10 < H ≤ 460mm	<b>515-376</b>	20mm (staggered)	0.001mm	±2.5µm	2.5µm	±2µm	13.6
10 < H ≤ 610mm	<b>515-378</b>	20mm (staggered)	0.001mm	±3.5µm	2.5µm	±2.5µm	16.0

### Inch/Metric

Range (H)	Order No.	Block step	Resolution	Block Pitch Accuracy	Parallelism	Micrometer Head Accuracy	Mass (kg)
.5" < H ≤ 12"	<b>515-375</b>	1" (staggered)	.0001" / 0.001mm	±.0001"	.00005"	±.0001"	9.5
.5" < H ≤ 18"	<b>515-377</b>	1" (staggered)	.0001" / 0.001mm	±.0001"	.0001"	±.0001"	13.6
.5" < H ≤ 24"	<b>515-379</b>	1" (staggered)	.0001" / 0.001mm	±.0001"	.0001"	±.0001"	16.0

# Riser Blocks

## SERIES 515

### FEATURES

- These riser blocks are specially designed for standard/Digimatic height masters.



### SPECIFICATIONS

Metric			
Height	Order No.	Accuracy of height	Mass (kg)
150mm	515-113	$\pm 0.6\mu\text{m}$	5.7
300mm	515-114	$\pm 1.0\mu\text{m}$	11.3
600mm	515-115	$\pm 2.0\mu\text{m}$	31

Inch			
Height	Order No.	Accuracy of height	Mass (kg)
6"	515-116	$\pm 20\mu\text{in}$	5.7
12"	515-117	$\pm 40\mu\text{in}$	11.3
24"	515-118	$\pm 80\mu\text{in}$	31

# Auxiliary Block Kit

## SERIES 515 — for Bore Gage

### FEATURES

- Used for efficient zero-setting of dial bore gages and tubular inside micrometers (18 - 150mm) on a Height Master.

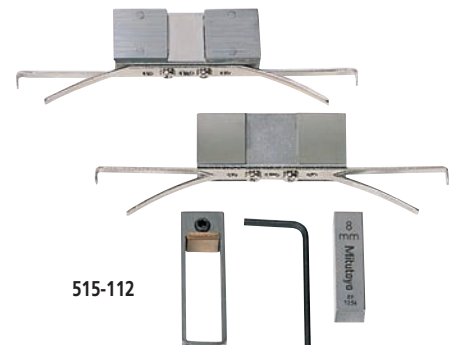

Bore gage zero-setting



### SPECIFICATIONS

Metric	
Order No.	Applicable height master
515-110	Universal Height Master
515-111	Digimatic Height Master
515-112	Height Master

Inch	
Order No.	Applicable height master
515-119	Universal Height Master, Height Master (515-310)
515-120	Digimatic Height Master
515-121	Height Master (515-311)

# Universal Height Master

**SERIES 515 — Usable in Vertical and Horizontal Orientations**

## FEATURES

- The Universal Height Master is designed for both vertical and horizontal orientations, providing a wide range of applications such as accuracy checking of machine tool table movements.
- Fitted wooden case supplied.

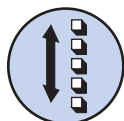
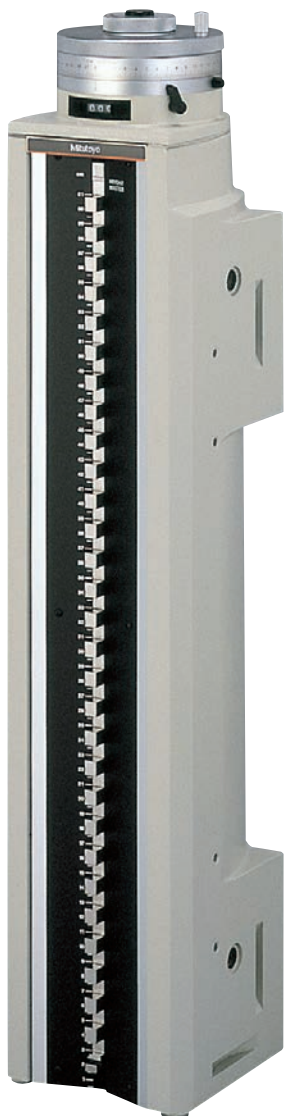

Single-row 10mm blocks (movable)



Vertical orientation

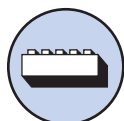

Horizontal orientation



Riser block

515-520

## SPECIFICATIONS

### Metric

Range (R)	Order No.	Block step	Graduation	Block Pitch Accuracy	Parallelism of Block	Micrometer Head Accuracy	Mass (kg)
$5 < R \leq 610\text{mm}$	<b>515-520</b>	10mm (straight)	0.001mm	$\pm 1.5\mu\text{m}$	$1.0\mu\text{m}$	$\pm 1.2\mu\text{m}$	42
$5 < R \leq 1010\text{mm}$	<b>515-523</b>	10mm (straight)	0.001mm	$\pm 3.5\mu\text{m}$	$2.5\mu\text{m}$	$\pm 1.5\mu\text{m}$	63.5

### Inch

Range (R)	Order No.	Block step	Graduation	Block Pitch Accuracy	Parallelism of Block	Micrometer Head Accuracy	Mass (kg)
$.2" < R \leq 18.2"$	<b>515-512</b>	.5" (straight)	.00001"	$\pm .00005"$	.00006"	$\pm .00004"$	42
$.2" < R \leq 24.2"$	<b>515-510</b>	.5" (straight)	.00001"	$\pm .0001"$	.00006"	$\pm .00004"$	50
$.2" < R \leq 40.2"$	<b>515-513</b>	.5" (straight)	.00001"	$\pm .00015"$	.00008"	$\pm .00006"$	63.5



## Technical Data

Graduation: 0.001mm or .00001"  
 Counter Resolution: .001" or 0.01mm  
 Character Height: .16" / 4mm  
 Block arrangement: Straight arrangement

### Micrometer Head

Travel stroke: 1" or 20mm  
 Pitch: .025"/rev or 0.5mm/rev  
 Hysteresis: .00004" / 1.2 $\mu\text{m}$  up to 24.2" / 610mm  
 .00006" / 1.5 $\mu\text{m}$  for 40.2" / 1010mm

Block pitch accuracy:  $\pm 1.5\mu\text{m}$  ( $0 < R \leq 310\text{mm}$ )  
 $\pm 2.5\mu\text{m}$  ( $310 < R \leq 610\text{mm}$ )  
 $\pm 3.5\mu\text{m}$  ( $610 < R \leq 1010\text{mm}$ )

Parallelism of blocks:  $1.0\mu\text{m}$  ( $0 < R \leq 310\text{mm}$ )  
 $2.5\mu\text{m}$  ( $310 < R \leq 1010\text{mm}$ )

Provided with inspection certificate.

## Optional Accessories

- 900574:** Supporting base for vertical operation  
 Mass: 3kg  
 (\*supplied as a standard for **515-523** and **515-513**)
- 515-112:** Auxiliary block kit for bore gage (mm)  
**515-119:** Auxiliary block kit for bore gage (inch)

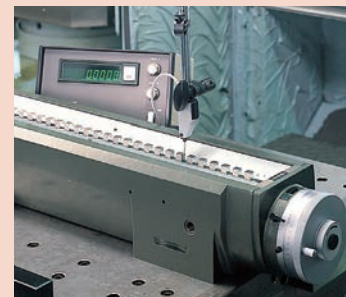

Using in horizontal orientation



Supporting base



# High Accuracy Check Master HMC-H

## SERIES 515

### Technical Data

Measuring range (R): Refer to the list of specifications.  
 Block pitch accuracy:  $\pm 1.2\mu\text{m}$  ( $0 < R \leq 310\text{mm}$ )  
 $\pm 1.8\mu\text{m}$  ( $310 < R \leq 610\text{mm}$ )  
 $\pm 2.5\mu\text{m}$  ( $610 < R \leq 1010\text{mm}$ )  
 $\pm 4.0\mu\text{m}$  ( $1010 < R \leq 1510\text{mm}$ )  
 Parallelism of blocks:  $1.0\mu\text{m}$  ( $0 < R \leq 450\text{mm}$ )  
 $1.5\mu\text{m}$  ( $450 < R \leq 1010\text{mm}$ )  
 $2.0\mu\text{m}$  ( $1010 < R \leq 1510\text{mm}$ )  
 Provided with inspection certificate.

### FEATURES

- Designed to check the accuracy of table movements of machine tools and calibrate CMMs. Permanently wrung stack of gage blocks is housed in a rigid frame.
- Can be used in either vertical and horizontal orientation.
- Fitted wooden case supplied.

### Specifications for Ceramic Check Master:

- Each measuring block is made of zirconia-based ceramic that requires no anti-corrosion treatment for measuring faces.
- Free from deterioration and dimensional changes over time.

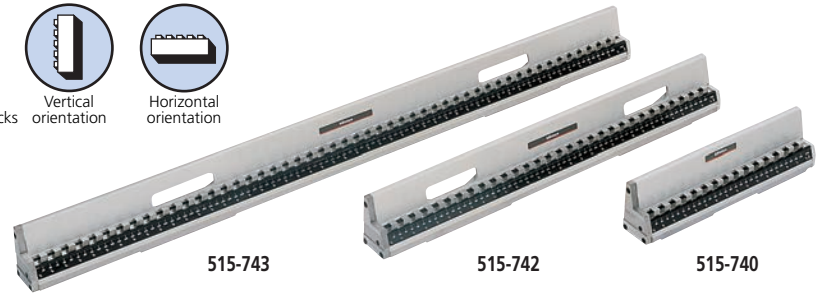
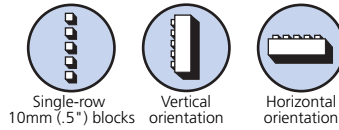

### SPECIFICATIONS

Range (R)	Order No.		Pitch		Accuracy of block pitch for the range shown below as measured from the bottom block				Length	Parallelism	Mass (kg)
	Steel	Ceramic	P	P	up to 300mm	300-600mm	600-1000mm	1000-1500mm			
300mm	515-740	515-760	20mm	10mm	$\pm 1.2\mu\text{m}$	—	—	—	331mm	$1\mu\text{m}$	3.6
450mm	515-741	515-761	20mm	10mm	$\pm 1.2\mu\text{m}$	$\pm 1.8\mu\text{m}$	—	—	482mm	$1\mu\text{m}$	5.4
600mm	515-742	515-762	20mm	10mm	$\pm 1.2\mu\text{m}$	$\pm 1.8\mu\text{m}$	—	—	631mm	$1.5\mu\text{m}$	7.2
1000mm	515-743	515-763	20mm	10mm	$\pm 1.2\mu\text{m}$	$\pm 1.8\mu\text{m}$	$\pm 2.5\mu\text{m}$	—	1037mm	$1.5\mu\text{m}$	12.0
1500mm	515-744	515-764	20mm	10mm	$\pm 1.2\mu\text{m}$	$\pm 1.8\mu\text{m}$	$\pm 2.5\mu\text{m}$	$\pm 4.0\mu\text{m}$	1546mm	$2\mu\text{m}$	18.0

### Inch

Range (R)	Order No.		Pitch		Accuracy of block pitch for the range shown below as measured from the bottom block				Length	Parallelism	Mass (kg)
	Steel	Ceramic	P	P	up to 12"	12-24"	24-40"	40-60"			
12"	515-730	515-750	1"	.5"	$\pm 50\mu\text{in}$	—	—	—	13.0"	$40\mu\text{in}$	3.4
18"	515-731	515-751	1"	.5"	$\pm 50\mu\text{in}$	$\pm 70\mu\text{in}$	—	—	19.0"	$40\mu\text{in}$	5.2
24"	515-732	515-752	1"	.5"	$\pm 50\mu\text{in}$	$\pm 70\mu\text{in}$	—	—	25.0"	$60\mu\text{in}$	6.9
40"	515-733	515-753	1"	.5"	$\pm 50\mu\text{in}$	$\pm 70\mu\text{in}$	$\pm 100\mu\text{in}$	—	41.0"	$60\mu\text{in}$	11.5
60"	515-734	515-754	1"	.5"	$\pm 50\mu\text{in}$	$\pm 70\mu\text{in}$	$\pm 100\mu\text{in}$	$\pm 158\mu\text{in}$	61.5"	$80\mu\text{in}$	17.3

### Optional Accessories

**601167:** Supporting base for vertical operation  
 (\*supplied as a standard for 515-523 and 515-513)

Dimensions: 14.2"(W) x 8.7"(D) x 8.3"(H)  
 360mm(W) x 220mm(D) x 210mm(H)  
 Mass: 3kg

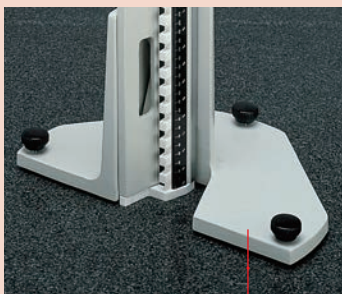

Supporting base

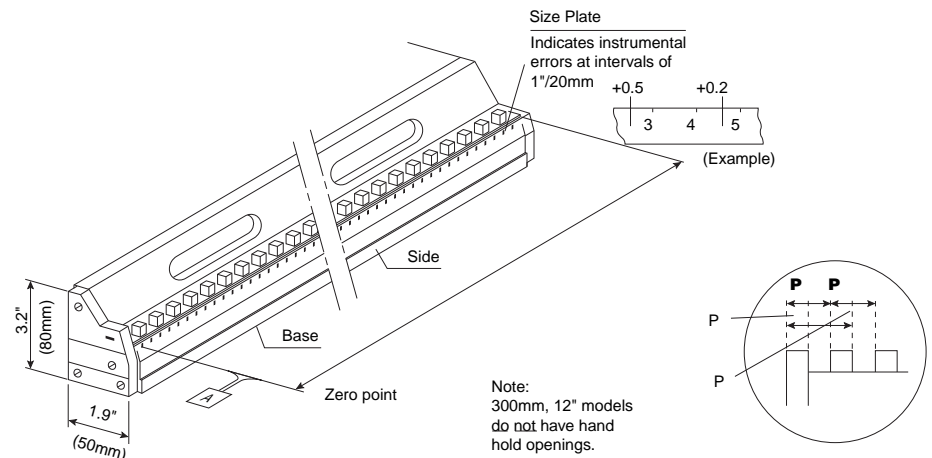

# CERA Straight Master SM-C

## SERIES 311 — Straightness Measuring Instrument

### FEATURES

CERA Straight master is a master gage used for the straightness inspection of each axis movement such as a CMM, machine tool, semiconductor related equipment and form measuring machine.

- Made from Alumina ceramic
- 50mm/2" pitch gradation scales
- Precision lapped measuring surface
- Double faced type is lapping the double face which can be used for straightness in horizontal and vertical as a reference square.
- Lightweight
- Supplied with fitted wooden case.



### SPECIFICATIONS

Metric		Inch		High accuracy model		
Nominal length	Order No.*	Nominal length	Order No.*	Straightness	Size (L x H x W)	Mass
400mm	311-302-33	16"	311-322-33	0.3μm	440 x 35 x 50mm	1.8kg
700mm	311-305-33	28"	311-325-33	0.5μm	740 x 35 x 50mm	3kg
1000mm	311-307-33	40"	311-327-33	1.0μm	1040 x 45 x 80mm	8kg
1300mm	311-309-33	52"	311-329-33	1.5μm	1340 x 45 x 80mm	10kg

Metric		Inch		Ultra high accuracy model		
Nominal length	Order No.*	Nominal length	Order No.*	Straightness	Size (L x H x W)	Mass
400mm	311-332-33	16"	311-342-33	0.2μm	440 x 35 x 50mm	1.8kg
700mm	311-335-33	28"	311-345-33	0.4μm	740 x 35 x 50mm	3kg
1000mm	311-337-33	40"	311-347-33	0.5μm	1040 x 45 x 80mm	8kg
1300mm	311-339-33	52"	311-349-33	0.7μm	1340 x 45 x 80mm	10kg

Double faced type



### SPECIFICATIONS

Metric		Inch		Double faced model		
Nominal length	Order No.*	Nominal length	Order No.*	Straightness	Size (L x H x W)	Mass
400mm	311-352-33	16"	311-362-33	0.3μm	440 x 45 x 80mm	3.2kg
700mm	311-355-33	28"	311-365-33	0.5μm	740 x 45 x 80mm	5.5kg
1000mm	311-357-33	40"	311-367-33	1.0μm	1040 x 45 x 80mm	8kg
1300mm	311-359-33	52"	311-369-33	1.5μm	1340 x 45 x 80mm	10kg

### Technical Data

Provided with inspection certificate.

### Cross section

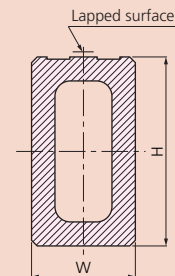

### Double faced type

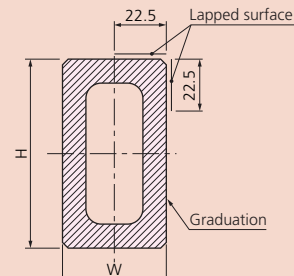

# Square Master

## SERIES 311 — Squareness / Straightness Measuring Instrument

### Technical Data

Squareness: Refer to the list of specifications  
 Straightness: Refer to the list of specifications  
 Dial test indicator provided  
 Range: 0.2mm  
 Graduation: 0.002mm  
 Accuracy: 3µm

### Optional Accessory

—: Riser blocks (see page E-27.)\*  
**517-665:** Granite square, 45 (W) x 140 (D) x 280 (H) mm  
**900571:** Adjustable holder  
**900551:** Extension holder  
**900565:** Feeler\*\*  
 \*Not available for 450mm model.  
 \*\*Adapter (**902803**) is required for metric model.

### Adjustable holder

No.900571

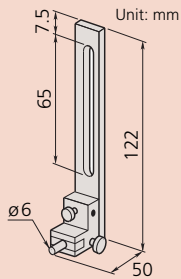

### Extension holder

No.900551

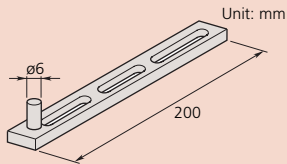

### Feeler

No.900565

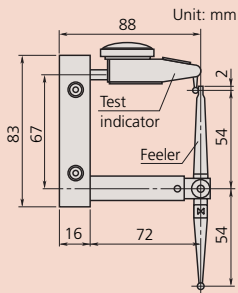

### FEATURES

- Squareness (perpendicularity) and straightness measurements can be performed accurately and efficiently by moving a lever.
- With a dial test indicator for reading displacements.
- Its own squareness is adjustable for high accuracy measurement.



311-215



311-225



311-245

### SPECIFICATIONS

Metric				
Vertical travel	Order No.	Squareness	Straightness	Mass (kg)
150mm	<b>311-215</b>	3µm	2µm	13.7
250mm	<b>311-225</b>	6µm	2.5µm	16.2
450mm	<b>311-245</b>	9µm	3.5µm	24

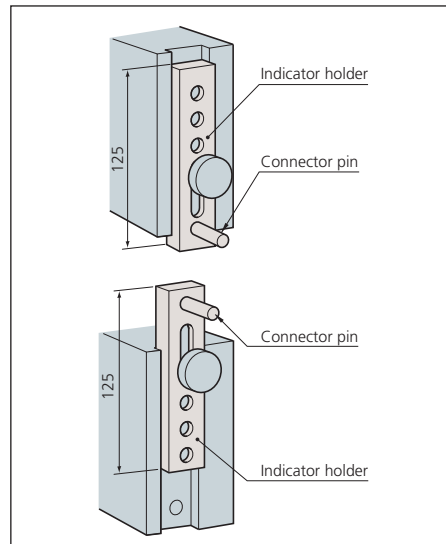

# Standard Scales

**SERIES 182 — Made of Low Expansion Glass**

## FEATURES

- High precision glass scales manufactured under Mitutoyo's leading-edge Linear Scale production technology.
- High accuracy is guaranteed to be used as a standard for calibrating graduated scales.



## DIMENSIONS

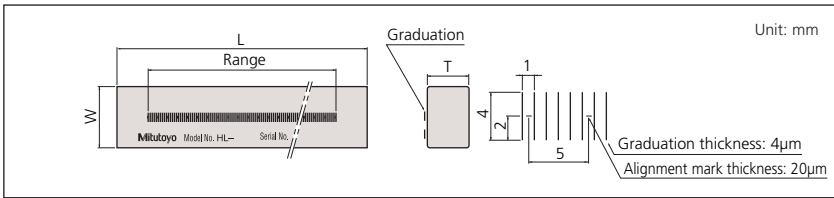

## Technical Data

Accuracy (at 20°C):  $(0.5+L/1000)\mu\text{m}$ ,  
 L = Measured length (mm)  
 Glass material: Low expansion glass  
 Thermal expansion coefficient:  $8 \times 10^{-6}/\text{K}$   
 Graduation: 1mm  
 Graduation thickness: 4µm  
 Mass: 0.75kg (250mm), 1.8kg (500mm)

## SPECIFICATIONS

### Metric

Range	Order No.	L	W	T
250mm	<b>182-501-50</b>	280mm	20mm	10mm
250mm	<b>182-501-60*</b>	280mm	20mm	10mm
500mm	<b>182-502-50</b>	530mm	30mm	20mm
500mm	<b>182-502-60*</b>	530mm	30mm	20mm

\*with English JCSS certificate.

# Working Standard Scales

**SERIES 182**

## FEATURES

- High precision glass scales manufactured under Mitutoyo's leading-edge Linear Scale production technology.
- Ideal for checking magnification accuracy of profile projectors and microscopes, and the table feeding accuracy of measuring equipment.

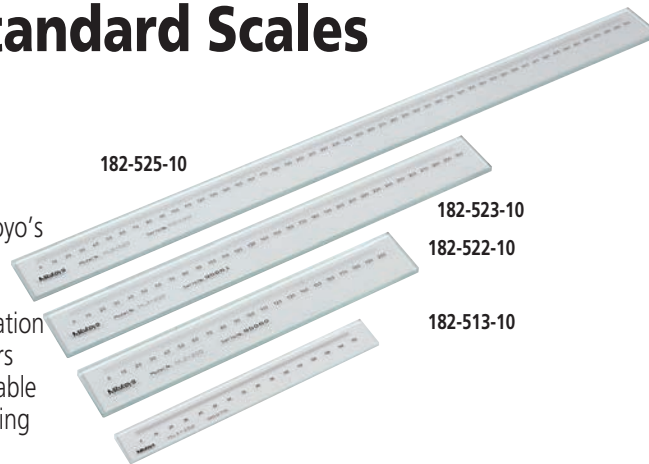

## DIMENSIONS

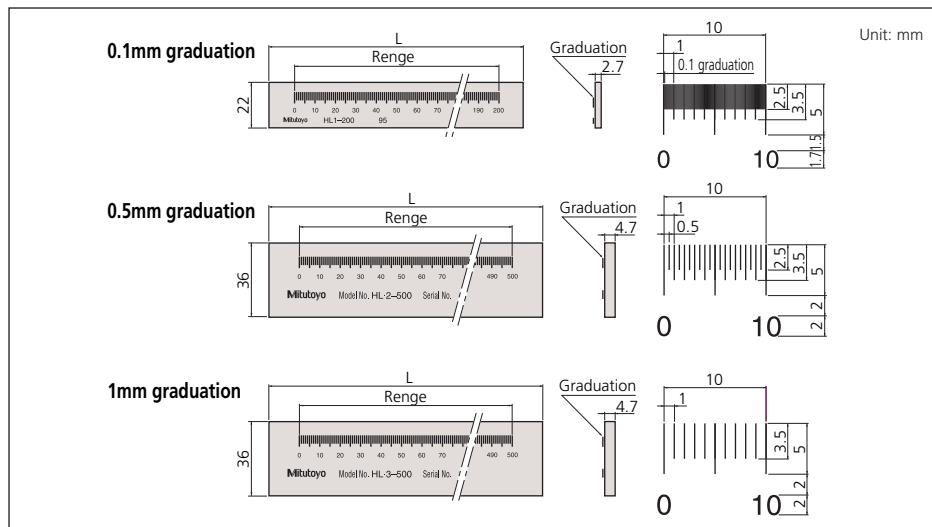

## Technical Data

Accuracy (at 20°C):  $(1.5+2L/1000)\mu\text{m}$ ,  
 L = Measured length (mm)  
 Glass material: Sodium glass  
 Thermal expansion coefficient:  $8.5 \times 10^{-6}/\text{K}$   
 Graduation: 0.1mm (thickness: 20µm)  
 0.5mm (thickness: 50µm)  
 1mm (thickness: 100µm)

## SPECIFICATIONS

### Metric

Range	Order No.	Graduation	L	Mass
50mm	<b>182-511-10</b>	0.1mm	75mm	0.23kg
100mm	<b>182-512-10</b>	0.1mm	125mm	0.24kg
150mm	<b>182-513-10</b>	0.1mm	175mm	0.35kg
200mm	<b>182-514-10</b>	0.1mm	225mm	0.36kg
100mm	<b>182-521-10</b>	0.5mm	130mm	0.27kg
200mm	<b>182-522-10</b>	0.5mm	230mm	0.32kg
300mm	<b>182-523-10</b>	0.5mm	330mm	0.57kg
400mm	<b>182-524-10</b>	0.5mm	430mm	0.71kg
500mm	<b>182-525-10</b>	0.5mm	530mm	0.86kg
250mm	<b>182-531-10</b>	1mm	280mm	0.55kg
500mm	<b>182-532-10</b>	1mm	530mm	0.86kg
750mm	<b>182-533-10</b>	1mm	780mm	1.22kg
1000mm	<b>182-534-10</b>	1mm	1030mm	1.54kg



# Steel Squares

## SERIES 916

Regular type and beveled-edge type steel squares.

All edges are hardened and precision ground. (Only blade is hardened on engineers Square)

### SPECIFICATIONS

#### Beveled Edge Squares

Inch

Size	Order No.	Outside Dim.	Squareness
2"	916-100	2 x 1.6"	.00010"
3"	916-101	3 x 2"	.00011"
4"	916-102	4 x 2.75"	.00012"
6"	916-103	6 x 4"	.00014"
8"	916-104	8 x 5"	.00018"

#### Regular Squares

Inch

Size	Order No.	Outside Dim.	Squareness
3"	916-401	2.9 x 1.9"	.00026"
4"	916-402	3.9 x 2.7"	.00028"
6"	916-403	5.9 x 3.9"	.00032"
8"	916-404	7.8 x 5.1"	.00036"
10"	916-405	9.8 x 6.5"	.00040"
12"	916-406	11.8 x 7.8"	.00044"
16"	916-407	15.7 x 9.8"	.00052"
20"	916-408	19.6 x 11.8"	.00059"
30"	916-409	29.7 x 15.7"	.00080"
40"	916-410	39.3 x 19.6"	.00116"

#### Regular Squares "Engineers Square"

Size	Order No.	Outside Dim.	Squareness
2"	916-590	2.70 x 1.98"	.00063"
3"	916-591	3.73 x 2.38"	.00063"
4"	916-592	4.65 x 2.97"	.00063"
6"	916-593	6.85 x 3.93"	.00063"
9"	916-594	10.50 x 6.30"	.0008"
12"	916-595	13.63 x 8.25"	.001"
18"	916-596	20.25 x 10.50"	.0012"
24"	916-597	26.83 x 13.35"	.0015"
2, 3, 4, 6" Set	916-598		
4, 6, 9, 12" Set	916-599		

#### Beveled Edge Squares with Beam

Inch

Size	Order No.	Outside Dim.	Squareness
3"	916-421	3 x 2"	.000091"
4"	916-422	4 x 2.75"	.000094"
6"	916-423	6 x 4"	.00010"
8"	916-424	8 x 5"	.00011"

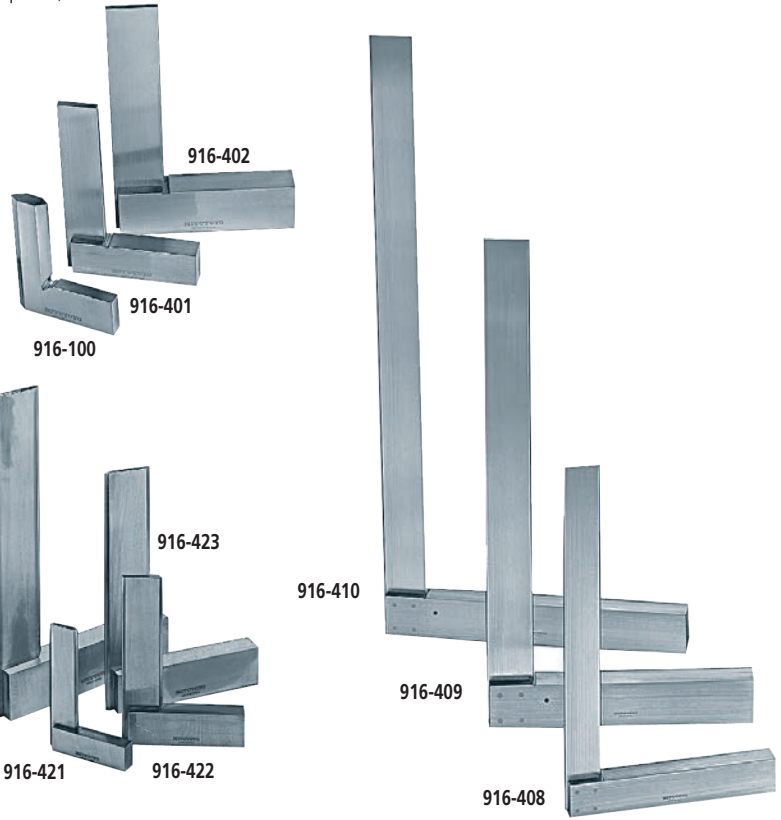

# High Precision Square

## SERIES 311

### FEATURES

The High Precision Square is a gage used for inspecting the travel straightness and axial perpendicularity of moving elements on equipment such as machine tools, CMMs, form measuring machines and semiconductor related equipment.

- Four precision-lapped reference surfaces.
- Better than 1µm/300mm straightness and perpendicularity.

### SPECIFICATIONS

Metric

Order No.	Dimension (W x L x T)	Mass
311-111	90 x 110 x 25mm	1.5kg
311-112	160 x 210 x 25mm	5.0kg
311-113	260 x 310 x 30mm	14.0kg

\* 311-113 is supplied with a removable handle.

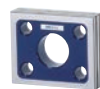

311-111



311-112



311-113

# Knife Edge Straight Edge

## SERIES 528

The test edge is approximately .004" in thickness, a cross section of which has radius to provide a straight line contact with the work surface. Straightness is  $\pm .00005$ ".

For ease of inspection, the blade is dyed in black, and the upper edge is covered with a grip plate. The acute angle is 30 degrees.

### SPECIFICATIONS

Length	Order No.	Remarks
4"	528-102	with protective cover
6"	528-103	with protective cover
8"	528-104	with protective cover
10"	528-105	with protective cover

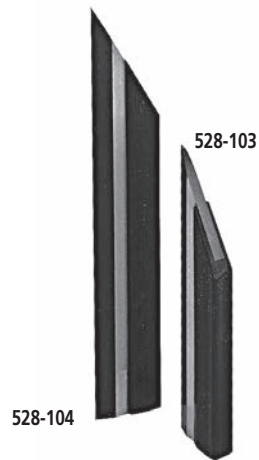

# Spring Dividers and Calipers

## SERIES 950

### FEATURES

- Spring Divider — Fully hardened and tempered joints, spring, washers and divider points.
- Outside Spring Caliper — Contact ends fully rounded to give accurate dimensions.
- Inside Spring Caliper — Ends fully rounded to give accurate contact with a workpiece.

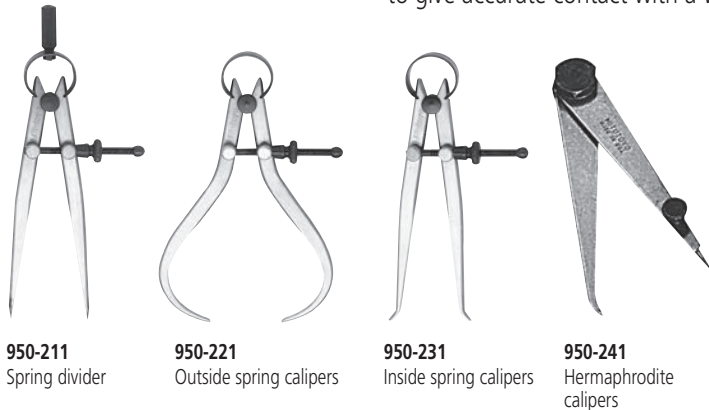

950-211  
Spring divider

950-221  
Outside spring calipers

950-231  
Inside spring calipers

950-241  
Hermaphrodite calipers

### SPECIFICATIONS

Range	Order No.			
	Spring divider	Outside spring calipers	Inside spring calipers	Hermaphrodite calipers
4" (100mm)	950-211	950-221	950-231	950-241
6" (150mm)	950-212	950-222	950-232	950-242
8" (200mm)	950-213	950-223	950-233	
10" (250mm)	950-214	950-224	950-234	
12" (300mm)	950-215	950-225	950-235	
6" (150mm)	—	—	950-236*	—

\* Quick nut model.

# Combination Square Set

## SERIES 180

### Technical Data

- Square head:** Used to set the rule at 90 degrees or 45 degrees to edge of a workpiece.
- Center head:** Used to locate centers of round workpieces
- Protractor head:** Used to set the rule at a desired angle to an edge of a workpiece. Also used for measuring angles.

### FEATURES

- Measuring head are attached to the graduated steel rule (blade), allowing versatile measurements on various types of workpieces
- The measuring head come hardened or cast iron-not-hardened
- Economy sets not including a protractor head are also available

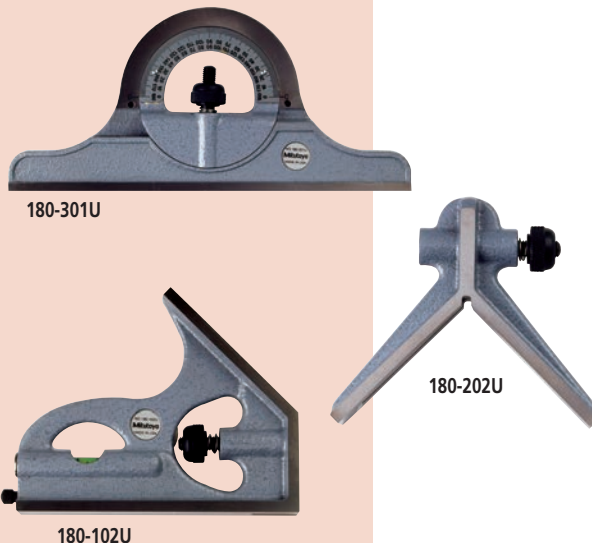
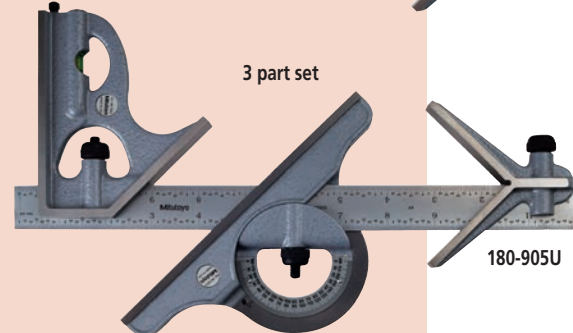
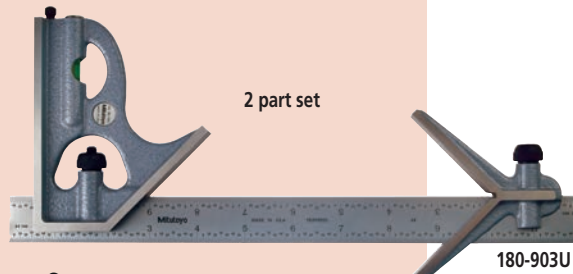
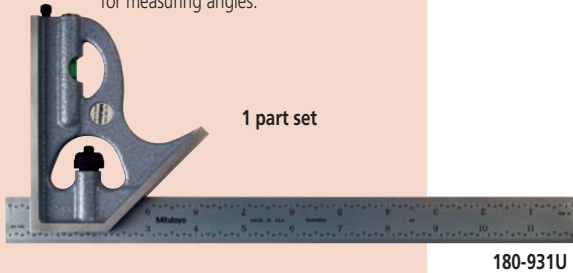

### SPECIFICATIONS

Head Only		Hardened
Order No.	Description	
180-102U	Square Head for 12"/300mm to 24"/600mm	
180-202U	Center Head for 12"/300mm to 24"/600mm	

Head Only		Cast iron-not hardened
Order No.	Description	
180-112U	Square Head for 12"/300mm to 24"/600mm	
180-212U	Center Head for 12"/300mm to 24"/600mm	
180-301U	Protractor Head for 12"/300mm to 24"/600mm	
180-113U	Double Square Head for 4"/100mm and 6"/150mm	

### Inch/Metric Hardened Combination Square Sets

Set No.	Blade		Square Head	Center Head	Protractor Head	
	Size	Type				
180-903U	12"	4R	180-501U	180-102U	180-202U	-
180-904U	12"	16R	180-502U	180-102U	180-202U	-
180-905U	12"	4R	180-501U	180-102U	180-202U	180-301U*
180-906U	12"	16R	180-502U	180-102U	180-202U	180-301U*
180-907U	12"/300mm	E/M	180-503U	180-102U	180-202U	180-301U*
180-910U	300mm	Metric	180-505U	180-102U	180-202U	180-301U*
180-931U	12"	4R	180-501U	180-102U	-	-
180-932U	12"	16R	180-502U	180-102U	-	-
180-933U	12"/300mm	E/M	180-503U	180-102U	-	-
180-934U	300mm	Metric	180-505U	180-102U	-	-

\*Cast iron-not hardened

### Inch/Metric Cast iron-not hardened Combination Square Sets

Set No.	Blade		Square Head	Center Head	Protractor Head	
	Size	Type				
180-803U	12"	4R	180-501U	180-112U	180-212U	-
180-804U	12"	16R	180-502U	180-112U	180-212U	-
180-805U	12"	4R	180-501U	180-112U	180-212U	180-301U
180-806U	12"	16R	180-502U	180-112U	180-212U	180-301U
180-807U	12"/300mm	E/M	180-503U	180-112U	180-212U	180-301U
180-810U	300mm	Metric	180-505U	180-112U	180-212U	180-301U
180-831U	12"	4R	180-501U	180-112U	-	-
180-832U	12"	16R	180-502U	180-112U	-	-
180-833U	12"/300mm	E/M	180-503U	180-112U	-	-
180-834U	300mm	Metric	180-505U	180-112U	-	-

\*Cast iron-not hardened

# Combination Square Set

## SERIES 180

### FEATURES

- Three measuring heads are attached to the stainless steel rule (blade), allowing versatile measurements on various types of workpieces.
- The measuring heads are hardened.
- Economy sets not including a protractor head are also available.

### Technical Data

- Square head: Used to set the rule at 90 degrees or 45 degrees to an edge of a workpiece.
- Center head: Used to locate centers of round workpieces
- Protractor head: Used to set the rule at a desired angle to an edge of a workpiece. Also used for measuring angles.

### SPECIFICATIONS

Inch / Metric		Blades only	
Order No.	Length	Graduations	Accuracy (length)
180-406U	4"	8, 16, 32, 64ths (4R)	+0.004" (+0.1mm) -0.0035" (-0.09mm)
180-407U	4"	32, 64, 50, 100ths (16R)	
180-408U	4" x 100mm	32, 64ths, 1, 0.5mm	
180-409U	100mm	1, .5, 1, 0.5mm	
180-401U	6"	8, 16, 32, 64ths (4R)	
180-402U	6"	32, 64, 50, 100ths (16R)	
180-403U	6" x 150mm	32, 64ths, 1, 0.5mm	
180-405U	150mm	1, .5, 1, 0.5mm	
180-501U	12"	8, 16, 32, 64ths (4R)	+0.005" (+0.13mm) -0.0035" (-0.09mm)
180-502U	12"	32, 64, 50, 100ths (16R)	
180-503U	12" x 300mm	32, 64ths, 1, 0.5mm	
180-505U	300mm	1, .5, 1, 0.5mm	
180-701U	18"	8, 16, 32, 64ths (4R)	
180-702U	18"	32, 64, 50, 100ths (16R)	
180-703U	18" x 450mm	32, 64ths, 1, 0.5mm	
180-705U	450mm	1, .5, 1, 0.5mm	
180-601U	24"	8, 16, 32, 64ths (4R)	+0.007" (+0.18mm) -0.0035" (-0.09mm)
180-602U	24"	32, 64, 50, 100ths (16R)	
180-603U	24" x 600mm	32, 64ths, 1, 0.5mm	
180-605U	600mm	1, .5, 1, 0.5mm	



180-501U

# Double Square Set

## SERIES 180

Inch Cast iron-not hardened square sets

Set Order No.	Blade		Double Square Head	
	Size	Type		
180-808U	4"	4R	180-406U	180-113U
180-809U	6"	4R	180-401U	180-113U

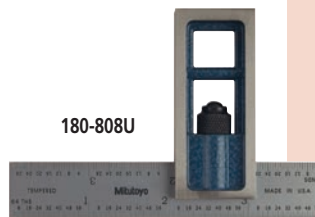

180-808U

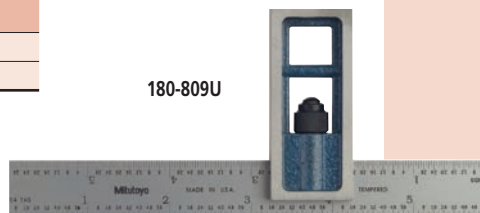

180-809U

# Steel Rules

## SERIES 182

### FEATURES

- Clear graduations on satin-chrome finish.
- Stainless tempered.



182-125



182-110

### SPECIFICATIONS

#### Wide Rigid Rules (thickness 3/64")

Order No.	Black Chrome Rule Order No.	Size	Graduations				Width	Accuracy (Length)
182-101	182-109	6"(4R)	1/8	1/16	1/32	1/64th	3/4"	+0.004" / -0.0035" (+0.1mm / -0.09mm)
182-102	182-112	6"(16R)	1/32	1/64	1/50	1/100th	3/4"	
182-103	182-110	6"(5R)	1/32	1/64	1/10	1/100th	3/4"	
182-104	182-113	6"(3R)	1/32	1/64	1/10	1/50th	3/4"	
182-105	182-114	6" x 150mm	1/32	1/64	1mm	0.5mm	3/4"	
182-106	—	6" x 150mm	1/50	1/100	1mm	0.5mm	3/4"	
182-107	—	6" x 150mm	1/10	1/100	1mm	0.5mm	3/4"	
182-108	—	6" x 150mm	1/10	1/50	1mm	0.5mm	3/4"	
182-111	182-115	150mm	1mm	0.5mm	1mm	0.5mm	19mm	
182-112	182-127	12"(4R)	1/8	1/16	1/32	1/64th	1"	
182-122	182-129	12"(16R)	1/32	1/64	1/50	1/100th	1"	
182-123	182-128	12"(5R)	1/32	1/64	1/10	1/100th	1"	
182-124	—	12"(3R)	1/32	1/64	1/10	1/50th	1"	
182-125	182-130	12" x 300mm	1/32	1/64	1mm	0.5mm	1"	
182-126	—	12" x 300mm	1/50	1/100	1mm	0.5mm	1"	
182-131	182-132	300mm	1mm	0.5mm	1mm	0.5mm	25mm	
182-241	182-146	18"(4R)	1/8	1/16	1/32	1/64	13/16"	+0.006" / -0.0035" (+0.15mm / -0.09mm)
182-142	182-148	18"(16R)	1/32	1/64	1/50	1/100th	13/16"	
182-143	182-147	18"(5R)	1/32	1/64	1/10	1/100th	13/16"	
182-144	—	18"(3R)	1/32	1/64	1/10	1/50th	13/16"	
182-145	—	18" x 450mm	1/32	1/64	1mm	0.5mm	13/16"	
182-151	—	450mm	1mm	0.5mm	1mm	0.5mm	30mm	
182-161	182-166	24"(4R)	1/8	1/16	1/32	1/64	13/16"	+0.007" / -0.0035" (+0.18mm / -0.09mm)
182-162	182-168	24"(16R)	1/32	1/64	1/50	1/100th	13/16"	
182-163	182-167	24"(5R)	1/32	1/64	1/10	1/100th	13/16"	
182-164	—	24"(3R)	1/32	1/64	1/10	1/50th	13/16"	
182-165	—	24" x 600mm	1/32	1/64	1mm	0.5mm	13/16"	
182-171	—	600mm	1mm	0.5mm	1mm	0.5mm	30mm	
182-401	—	36"(4R)	1/8	1/16	1/32	1/64	1 1/4"	
182-403	—	36"(16R)	1/32	1/64	1/50	1/100th	1 1/4"	
182-405	—	36"(5R)	1/32	1/64	1/10	1/100th	1 1/4"	
182-406	—	36" x 900mm	1/32	1/64	1mm	0.5mm	1 1/4"	
182-402	—	48"(4R)	1/8	1/16	1/32	1/64	1 1/4"	+0.008" / -0.004" (+0.2mm / -0.1mm)
182-404	—	48"(16R)	1/32	1/64	1/50	1/100th	1 1/4"	
182-407	—	48" x 1219.2mm	1/32	1/64	1mm	0.5mm	1 1/4"	

# Steel Rules

## SERIES 182

### FEATURES

- Clear graduations on satin-chrome finish.
- Stainless tempered.



182-265

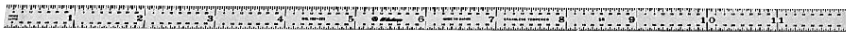

182-223

### SPECIFICATIONS

#### Full-Flexible Rules (thickness 1/64")

Order No.	Black Chrome Rule Order No.	Size	Graduations				Width	Accuracy (Length)
182-201	182-212	6"(4R)	1/8	1/16	1/32	1/64th	1/2"	+0.004" / -0.0035" (+0.1mm / -0.09mm)
182-202	182-214	6"(16R)	1/32	1/64	1/50	1/100th	1/2"	
182-203	182-213	6"(5R)	1/32	1/64	1/10	1/100th	1/2"	
182-204	182-215	6"(3R)	1/32	1/64	1/10	1/50th	1/2"	
182-205	182-216	6" x 150mm	1/32	1/64	1mm	0.5mm	1/2"	
182-206	—	6" x 150mm	1/50	1/100	1mm	0.5mm	1/2"	
182-207	—	6" x 150mm	1/10	1/100	1mm	0.5mm	1/2"	
182-208	—	6" x 150mm	1/10	1/50	1mm	0.5mm	1/2"	
182-211	182-209	150mm	1mm	0.5mm	1mm	0.5mm	12mm	+0.005" / -0.0035" (+0.13mm / -0.09mm)
182-221	182-217	12"(4R)	1/8	1/16	1/32	1/64th	1/2"	
182-222	182-219	12"(16R)	1/32	1/64	1/50	1/100th	1/2"	
182-223	182-218	12"(5R)	1/32	1/64	1/10	1/100th	1/2"	
182-224	—	12"(3R)	1/32	1/64	1/10	1/50th	1/2"	
182-225	182-220	12" x 300mm	1/32	1/64	1mm	0.5mm	1/2"	
182-226	—	12" x 300mm	1/50	1/100	1mm	0.5mm	1/2"	
182-231	182-210	300mm	1mm	0.5mm	1mm	0.5mm	12mm	
182-141	182-246	18"(4R)	1/8	1/16	1/32	1/64	3/4"	+0.006" / -0.0035" (+0.15mm / -0.09mm)
182-242	182-248	18"(16R)	1/32	1/64	1/50	1/100th	3/4"	
182-243	182-247	18"(5R)	1/32	1/64	1/10	1/100th	3/4"	
182-244	—	18"(3R)	1/32	1/64	1/10	1/50th	3/4"	
182-245	—	18" x 450mm	1/32	1/64	1mm	0.5mm	3/4"	
182-251	—	450mm	1mm	0.5mm	1mm	0.5mm	18mm	
182-261	182-266	24"(4R)	1/8	1/16	1/32	1/64	3/4"	+0.007" / -0.0035" (+0.18mm / -0.09mm)
182-262	182-268	24"(16R)	1/32	1/64	1/50	1/100th	3/4"	
182-263	182-267	24"(5R)	1/32	1/64	1/10	1/100th	3/4"	
182-264	—	24"(3R)	1/32	1/64	1/10	1/50th	3/4"	
182-265	—	24" x 600mm	1/32	1/64	1mm	0.5mm	3/4"	
182-271	—	600mm	1mm	0.5mm	1mm	0.5mm	18mm	

#### Flexible Rules

182-411	—	36"(4R)	1/8	1/16	1/32	1/64	3/4"	+0.007" / -0.0035" (+0.18mm / -0.09mm)
182-413	—	36"(16R)	1/32	1/64	1/50	1/100th	3/4"	
182-415	—	36"(5R)	1/32	1/64	1/10	1/100th	3/4"	
182-416	—	36" x 900mm	1/32	1/64	1mm	0.5mm	3/4"	+0.008" / -0.004" (+0.2mm / -0.1mm)
182-412	—	48"(4R)	1/8	1/16	1/32	1/64	3/4"	
182-414	—	48"(16R)	1/32	1/64	1/50	1/100th	3/4"	

# Semi-Flexible Rules

## SERIES 182

### FEATURES

- Engraved on frontside only



182-304

### SPECIFICATIONS

Inch/Metric								
Order No.	Size	Graduations					Width	Accuracy (Length)
182-301	4" x 100mm	1/2mm	1mm	1/32	1/64	1/16th	5/8"	+0.004" / -0.0035"
182-302	6" x 150mm	1/2mm	1mm	1/32	1/64	1/16th	5/8"	(+0.1mm / -0.09mm)
182-303	8" x 200mm	1/2mm	1mm	1/32	1/64	1/16th	5/8"	
182-304	10" x 250mm	1/2mm	1mm	1/32	1/64	1/16th	5/8"	+0.005" / -0.0035"
182-305	12" x 300mm	1/2mm	1mm	1/32	1/64	1/16th	5/8"	+0.13mm / -0.09mm)
182-307	20" x 500mm	1/2mm	1mm	1/32	1/64	1/16th	5/8"	+0.007" / -0.0035" (+0.18mm / -0.09mm)
182-309	40" x 1000mm	1/2mm	1mm	1/32	1/64	1/16th	5/8"	+0.008" / -0.004" (+0.2mm / -0.1mm)

# Hook Rules

## SERIES 182

### FEATURES

- Hardened and tempered tool steel.
- Hard chrome finish.
- Furnished with adjustable hook.



182-421

### SPECIFICATIONS

Order No.	Size	Graduations					Width	Accuracy (Length)
182-421	6" (4R)	1/8	1/16	1/32	1/64	3/4"	+0.004" / -0.0035"	
182-422	12" (4R)	1/8	1/16	1/32	1/64	1"	+0.005" / -0.0035"	
182-423	18" (4R)	1/8	1/16	1/32	1/64	1-1/8"	+0.006" / -0.0035"	
182-424	24" (4R)	1/8	1/16	1/32	1/64	1-1/8"	+0.007" / -0.0035"	

# Pocket Steel Rule

## SERIES 950

### FEATURES

- Engraved on frontside only.
- Backside: Inch/Metric equivalents



950-300

### SPECIFICATIONS

Order No.	Size	Graduation		Width	Accuracy (Length)
950-300	6" x 150mm	1mm	1/64ths	1/2"	+0.004" / -0.0035" (+0.1mm / -0.09mm)
950-301	6"	1/32nds	1/64ths	1/2"	+0.004" / -0.0035"

# Thickness Gages

## SERIES 950, 184

### FEATURES

- Metric thickness gages are available with tapered leaves.
- Each leaf is marked with its thickness.
- Each leaf is detachable if necessary.

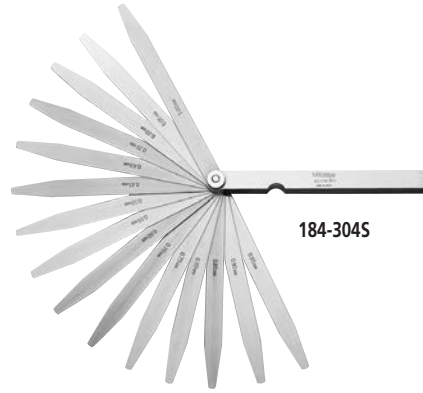

### SPECIFICATIONS

Inch				
Range	Order No.	Type of Blade	Blade Length	Composition of leaves
.002" - .035" (26 leaves)	950-251	Straight 1/2" width	3"	.002 thru .018" by .001" step plus .022, .024, .025, .028, .030, .032, .035"
.0015" - .025" (26 leaves)	950-252	Tapered 1/4" width at tip	3"	.002 thru .025" by .001" step plus .0015, .0025"
.0015" - .200" (15 leaves)	950-254	Straight 1/2" width	3"	.0015, .002, .003, .004, .006, .008, .010, .012, .015, .020, .030, .040, .075, .100, .200"
.0015" - .200" (13 leaves)	950-255	Straight 1/2" width	4.5"	.0015, .002, .003, .004, .006, .008, .010, .020, .030, .040, .075, .100, .200"
.0015" - .015" (8 leaves)	950-256	Straight 1/2" width	6"	.0015, .002, .003, .004, .008, .010, .012, .015"

Metric				
Range	Order No.	Type of Blade	Blade Length	Composition of leaves
0.05 - 1mm	184-313S	Straight 13mm width	100mm	28 leaves: 0.05 - 0.15mm by 0.01mm, 0.2 - 1mm by 0.05mm
	184-303S		150mm	
0.05 - 1mm	184-304S	Straight 13mm width	150mm	20 leaves: 0.05 - 1mm by 0.05mm
0.05 - 1mm	184-305S	Straight 13mm width	100mm	13 leaves: 0.05 - 0.3mm by 0.05mm, 0.4 - 1mm by 0.1mm
			150mm	
0.05 - 0.8mm	184-306S	Straight 13mm width	100mm	10 leaves: 0.05 - 0.2mm by 0.05mm, 0.3 - 0.8mm by 0.1mm
	184-308S		150mm	
0.03 - 0.5mm	184-307S	Straight 13mm width	100mm	13 leaves: 0.03 - 0.1mm by 0.01mm, 0.2 - 0.5mm by 0.1mm, 0.15mm
			150mm	
	184-302S		150mm	13 leaves: 0.03 - 0.1mm by 0.01mm, 0.2 - 0.5mm by 0.1mm, 0.15mm

### Technical Data

Accuracy of Leaves Thickness	Tolerance
<b>Nominal Thickness</b>	
Metric	
0.01mm to less than 0.06mm:	±0.003mm
0.06mm to less than 0.10mm:	±0.004mm
0.10mm to less than 0.35mm:	±0.005mm
0.35mm to less than 0.65mm:	±0.008mm
0.65mm to less than 3.0mm:	±0.01mm
Inch	
.0015 to less than .007":	±.0002"
.007 to less than .015":	±.0003"
.015 to less than .025":	±.0004"
.026 to less than .030":	±.00045"
.031 to less than .040":	±.0005"
.041 to less than .075":	±.00055"
.076 to less than .100":	±.0006"
.101 to less than .200":	±.00065"
.200" and over :	±.00075"

# Precision Levels

## SERIES 960

### FEATURES

- High precision longitudinal and transverse vials make it possible to check or level surfaces.

### SPECIFICATIONS

Order No.	Sensitivity	Accuracy	Dimensions (W x D x H)
960-703	0.02mm/m	±0.006mm	200 x 44 x 200mm

Order No.	Sensitivity	Accuracy	Dimensions		
			W	D	H
960-611	.0012"/12"	±.0006"	7.87"	1.73"	1.50"
960-612	.0006"/12"	±.0003"	7.87"	1.73"	1.50"
960-613	.00024"/12"	±.00017"	7.87"	1.73"	1.50"



960-611

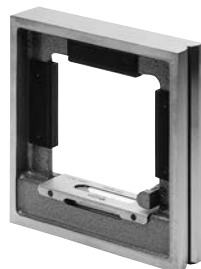

960-703



# Digital Universal Protractor

## SERIES 187

### Technical Data

Range:	-360° to +360°
Tolerance:	±2' (±0.03°)
Repeatability:	1'
Resolution:	1' (0.01°)
Battery:	Lithium Battery
Battery life:	2,000 hours

### Function

Presetting

### Standard Accessories

12" Blade (Code No. 187-103)  
 Battery (CR2032) (Part No. 055AA217)  
 Clamp box for Inch Height Gage (Part No. 950749)  
 Plastic Case

### Optional Accessories

187-104	6" blade
187-105	Acute angle attachment
950750	Clamp box for Metric Height Gage
905338	Connecting cable (40" / 1m)
905409	Connecting cable (80" / 2m)

### FEATURES

- Data output function make it easy to see the statistical data.
- Can be attached to height gages, gage holder (950750, metric)
- Setting preset value.
- Removable blade.



### SPECIFICATIONS

Code No.	187-552
Model	BP-D300E
Blade	12" (187-103)
Display	LCD - 5 digit, (-) sign, character height 6.5mm
Measuring range	-360° ~ +360°
Resolution	1' (0.01°)
Accuracy	± 2' (±0.03°)
Repeatability	1' (0.01°)
Mass	1.45 lbs (659g)
Dust / Water protection level	IP40
Function	Zero, Direction select, Data output / Data hold, Preset, Switchable Seagesimal or Decimal Notation
Max. response speed	3 rps
Battery	Lithium battery (CR2032) 1 pc. (Part No. 055AA217)
Battery life	2,000 hours
Alarm	Battery voltage low, Over speed error (Err)
Temperature	Operation temperature: 0 to 40°C Storage temperature: -10 to 60°C

### DIMENSIONS

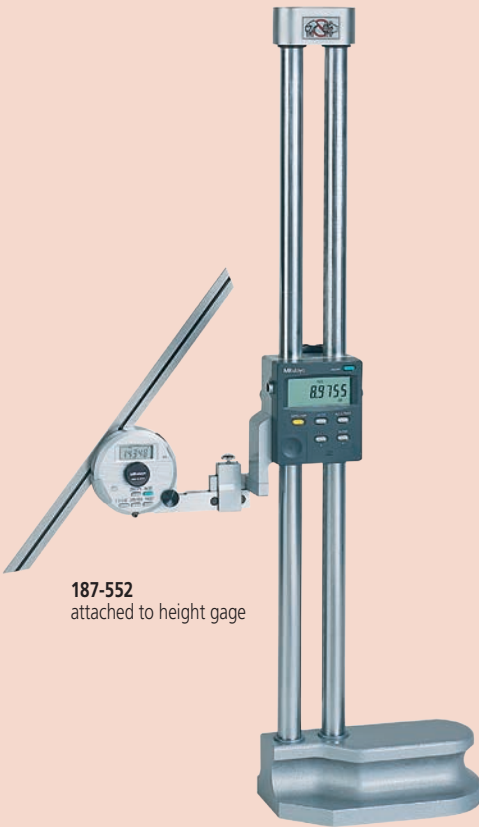
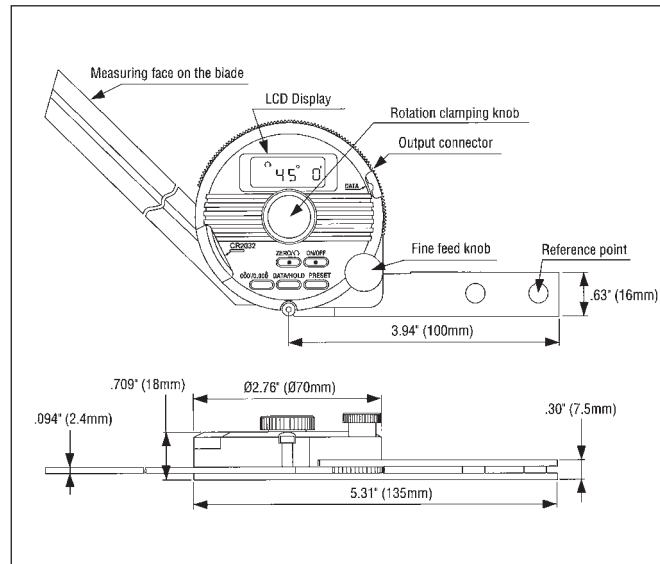

187-552  
attached to height gage

# Universal Bevel Protractor

## SERIES 187

### FEATURES

- High-precision angle gage for accurate angle measurement of machines, molds, and jigs.
- Can be attached to height gages.

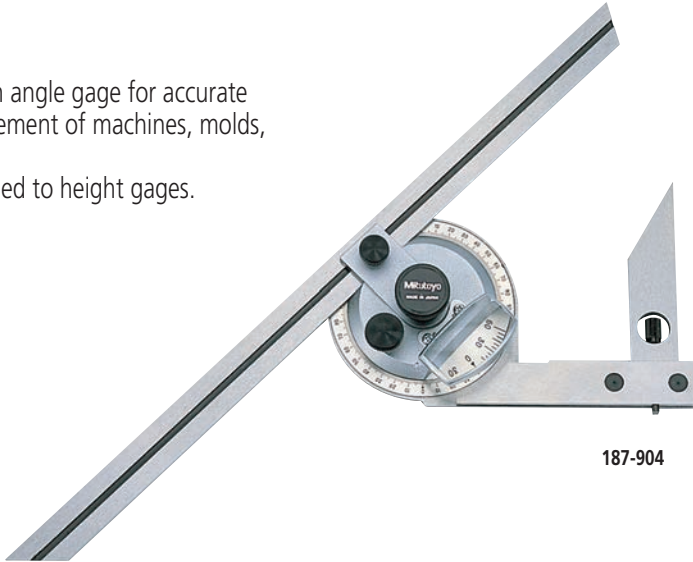

187-904

### Technical Data

Graduation:	5min. (0° - 90° - 0°)
Accuracy	
Vernier	±5'
Straightness	[.00016" + (.00005xL/2)]"
Parallelism	[.00016" + (.00005xL/2)]"
L = Length in inch	
Diameter:	2.56" / 70mm

### SPECIFICATIONS

#### Universal Bevel Protractors

Graduation			
Order No.	Dial	Vernier	Remarks
187-904	1°	5 min	with 6" blade (187-104) and Clamp box for Inch Height Gages (950749)
187-906	1°	5min	with 12" blade (187-103) and Clamp box for Inch Height Gages (950749)

#### Universal Bevel Protractor Accessories and Parts

Order No.	Remarks
187-103	12" Blade.
187-104	6" Blade.
187-105	Acute angle attachment
950749	Clamp box for Inch Height Gages
950750	Clamp box for Metric Height Gages

### DIMENSIONS

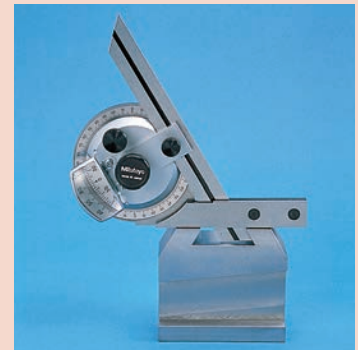
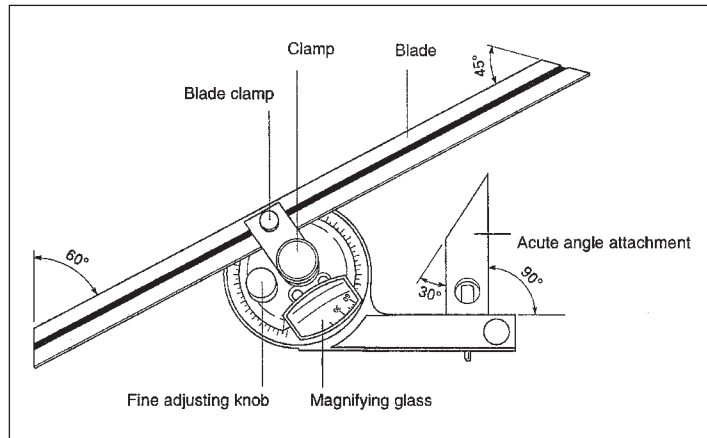

# Protractor

## SERIES 968

Basegular Base Protractor's scale plate and indicator blade are made entirely of stainless steel. (968-201) (968-202 and 986-203 Satin chrome finish). With 6" arm.

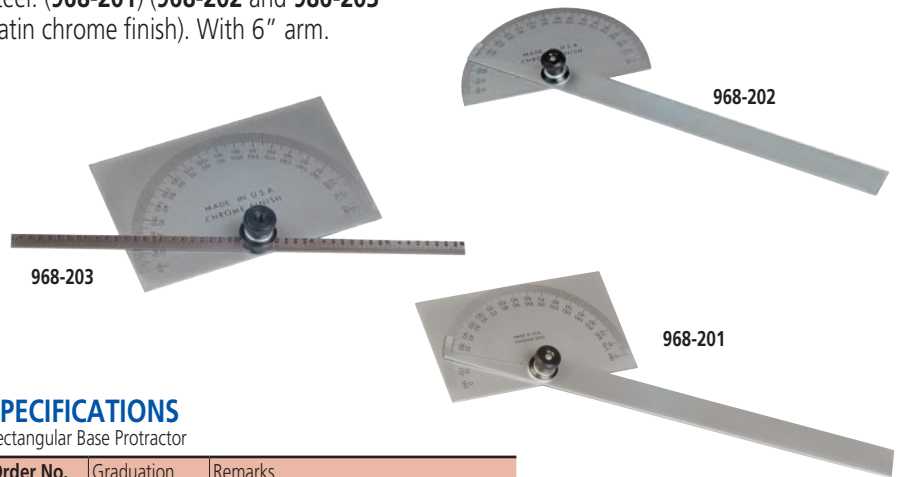

### SPECIFICATIONS

Rectangular Base Protractor

Order No.	Graduation	Remarks
968-201	1°	Protractor Graduation: 0°-90°, 90°-180°, 180°-90°, 90°-0°
968-202	1°	Semi-Circle: 0°-180°, 180°-0°
968-203*		Rectangle: 0°-180°, 180°-0°

\*6" Arm with graduation rule.

### DIMENSIONS

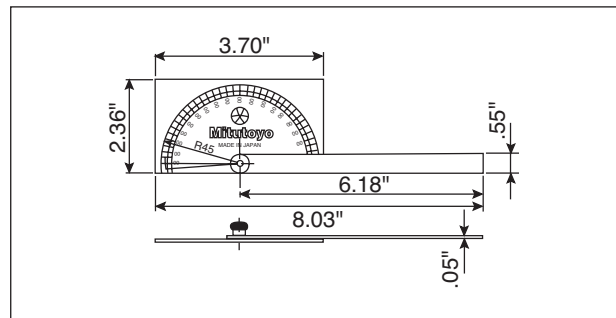

# Bevel Protractor

## SERIES 187

### Technical Data

Graduation: 5 min. (0° - 90° - 0°)  
Blade edge angle: 30° and 60°  
Diameter: 2.56" / 70mm

### FEATURES

- Consists of three sheets of stainless steel, the middle one of which is made for angle measurements.

### SPECIFICATIONS

Order No.	Graduation	Remarks
187-201	1° / 5 min	Center black knob locks the blade position Protractor Graduation: 0°-90°, 90°-0°

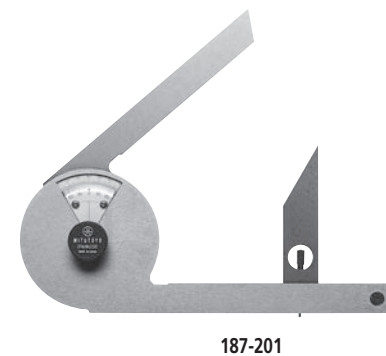

# Depth Gage, Adjustable Angle

## SERIES 950

### FEATURES

- Head made of hardened steel.
- Base surface measures 2-1/2" x 1/8" thick.
- Includes 6" rule: 7/32" wide and .041" thick.
- Includes 6" rod: 3/32" diameter.

### SPECIFICATIONS

Order No.	Protractor Graduation	Rule Graduation
950-271	30°, 45°, 60°	1/32", 1/64"



# Zero-It

## SERIES 950

"Zero-It" is specially designed for MITUTOYO Test Indicators with Dovetails, and functions as a quick and practical work positioning device.

Attach "Zero-It" directly to the collet, then zero in the work position by reading MITUTOYO

Test Indicator. The hardened clamping post consists of three ODs, from top, 1/4", 3/8" and 1/2", and has hardness of approximately 58 to 60 Rockwell C.

### SPECIFICATIONS

Order No.	Coarse	Fine
950-110	10°	3/8"

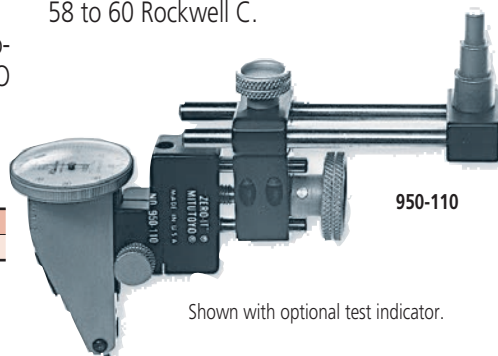

Shown with optional test indicator.

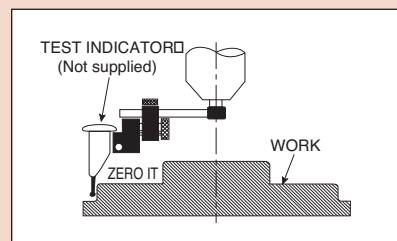

# Zero-Setter

## SERIES 950

Fast and sure establishment of "0" reference point with built-in indicator.

Spring loaded setting face to safe guard against damage from over run.

Body dia. 1.44" (36.5mm)

Wooden case included.

### SPECIFICATIONS

Order No.	Height	Graduation
950-111	1"	.0005"
950-112	25mm	0.01mm



950-111

# Angle Gages

**SERIES 186**

## FEATURES

- Manufactured from stainless steel, satin finished.
- 18 individual gages for easy use.
- Eight gaging surfaces per gage.
- Precision finished edges for accurate checking.
- Each gage checks primary, 1/2 primary and complementary angles.
- Sharp cornered workpieces can be checked at all 8 angles except below 50° on primary angle 2.
- Quick and accurate inspection of angles and I.D. or O.D. chamfers—in or out of the machine.
- Positioning of lathe tools for chamfers.
- Inspecting angles on ground form tools and cutters.
- Fast set-ups and fixturing of workpieces.
- Eliminates time consuming measuring set-ups.



186-910

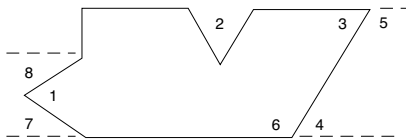

Angles 1, 2, 3, 4 are primary  
Angles 5, 6, are complementary  
Angles 7, 8 are 1/2 primary

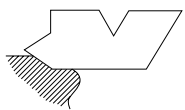

Gaging of angles of adjoining inside/outside diameters or flat surfaces.

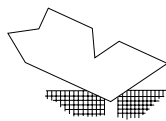

Gaging of the countersink angles of drilled and tapped holes.

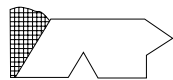

Gaging of primary and complementary angles from a surface plate.

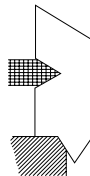

Gaging of I.D. and O.D. chamfers. Included angles are easily verified.

## SPECIFICATIONS

Set Order No.	Description	No. of Leaves
186-910	Angle Gage Set w/case	18

## Individual Part No.

Inch				
Part No.	Primary Angle	1/2 Primary Angle	Accuracy	Complementary Angle
051000*	5°	2° 30'	±5'	175°
051001*	10°	5°	±5'	170°
051002*	15°	7° 30'	±5'	165°
051003	20°	10°	±5'	160°
051004	35°	12° 30'	±5'	155°
051005	30°	15°	±5'	150°
051006	35°	17° 30'	±5'	145°
051007	40°	20°	±5'	140°
051008	45°	22° 30'	±5'	135°
051009	50°	25°	±5'	130°
051010	55°	27° 30'	±5'	125°
051011	60°	30°	±5'	120°
051012	65°	32° 30'	±5'	115°
051013	70°	35°	±5'	110°
051014	75°	37° 30'	±5'	105°
051015	80°	40°	±5'	100°
051016	85°	42° 30'	±5'	95°
051017	90°	45°	±5'	90°
051018	Vinyl Case			

\* Angle 2 omitted

# Angle Blocks

## SERIES 981

### SPECIFICATIONS

Order No.	Angle	Accuracy	Remarks
010001	1/4°	±20 sec	Hardened steel over HRC 55 Precision ground throughout
010002	1/2°		
010003	1°		
010004	2°		
010005	3°		
010006	4°		
010007	5°		
010008	10°		
010009	15°		
010010	20°		
010011	25°		
010012	30°		
010013	45°, 45°, 90°	± 40 sec	
010014	30°, 60°, 90°		



981-102

Set Order No.	Remarks
981-101	10 pc. Set (Order No. 010003-010012)
981-102	12 pc. Set (Order No. 010001-010012)
981-103	2 pc. Set (Order No. 010013-010014)

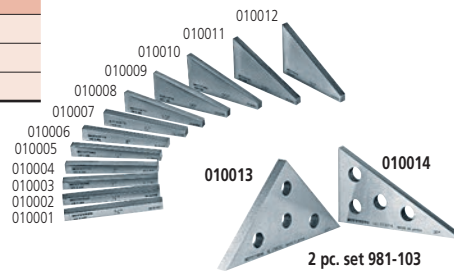

2 pc. set 981-103

# Adjustable Parallels

## SERIES 985

### FEATURES

- Consists of two precision ground pieces which slide smoothly on each other.
- Locked into position by set screws.
- Can be quickly inserted into openings and expanded to exact size, then measured with a micrometer.

### SPECIFICATIONS

Order No.	Remarks
985-130	4 pcs. Adjustable Parallel Set 3/8 – 1-15/16"
985-131	6 pcs. Adjustable Parallel Set 3/8 – 2-1/4"
985-132	Adjustable Parallel 3/8 – 1/2"
985-133	Adjustable Parallel 1/2 – 11/16"
985-134	Adjustable Parallel 11/16 – 15/16"
985-135	Adjustable Parallel 15/16 – 1-5/16"
985-136	Adjustable Parallel 1-5/16 – 1-3/4"
985-137	Adjustable Parallel 1-3/4 – 2-1/4"

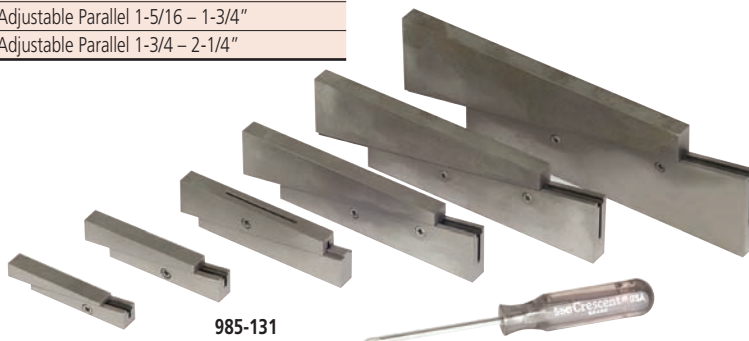

985-131

# Radius Gages

## SERIES 186

### FEATURES

- Radius size is stamped on each gage.
- Both concave and convex radius gages become a pair.
- With a locking clamp.

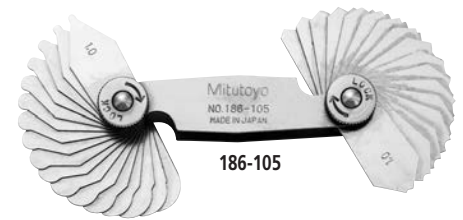

### SPECIFICATIONS

#### Metric

Range	Order No.	Composition of leaves	Remarks
0.4 - 6mm	<b>186-110</b>	18 leaves: 0.4, 0.8, 1, 1.2, 1.5, 1.6mm, 1.75 - 3mm by 0.25mm, 3.5 - 6mm by 0.5mm	90° arc
0.5 - 13mm	<b>186-902</b>	26 leaves: 0.5 - 13mm by 0.5mm	90° arc
1 - 7mm	<b>186-105</b>	34 pairs: 1 - 3mm by 0.25mm 3.5 - 7mm by 0.5mm	180° arc
7.5 - 15mm	<b>186-106</b>	32 pairs: 7.5 - 15mm by 0.5mm	180° arc
15.5 - 25mm	<b>186-107</b>	15 pairs: 15.5 - 20mm by 0.5mm, 21 - 25mm by 1mm	180° arc

#### Inch

Range	Order No.	Composition of leaves	Remarks
1/32" - 17/64"	<b>186-103</b>	16 leaves: 1/32" - 17/64" by 64ths	90° arc
1/32" - 1/4"	<b>186-101</b>	15 pairs: 1/32" - 1/4" by 64ths	180° arc
17/64" - 1/2"	<b>186-102</b>	16 pairs: 17/64" - 1/2" by 64ths	180° arc
9/32" - 33/64"	<b>186-104</b>	16 leaves: 9/32" - 33/64" by 64ths	90° arc

# Pitch Gages

## SERIES 188, 950

### FEATURES

- Thread pitch size is stamped on each gage.
- Metric, Unified, and Whitworth screw pitch gages.

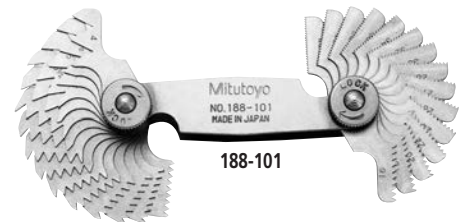

### SPECIFICATIONS

#### Metric Screw Pitch Gages (60°)

Range	Order No.	Composition of leaves
0.25 - 2.5mm	<b>188-153</b>	28 leaves: 0.25, 0.30, 0.35, 0.40, 0.45, 0.50, 0.55, 0.60, 0.65, 0.70, 0.75, 0.80, 0.85, 0.90, 1.00, 1.10, 1.20, 1.25, 1.30, 1.40, 1.50, 1.60, 1.70, 1.75, 1.80, 1.90, 2.00, 2.50 mm
0.35 - 6mm	<b>188-130</b>	22 leaves: 0.35, 0.4, 0.45, 0.5, 0.6, 0.7, 0.75, 0.8, 1, 1.25, 1.5, 1.75, 2, 2.5, 3, 3.5, 4, 4.5, 5, 5.5, 6mm and 60° angle gage
0.4 - 7mm	<b>188-122</b>	21 leaves: 0.4, 0.5, 0.7, 0.75, 0.8, 0.9, 1, 1.25, 1.5, 1.75, 2, 2.5, 3, 3.5, 4, 4.5, 5, 5.5, 6, 6.5, 7mm
0.4 - 7mm	<b>188-121</b>	18 leaves: 0.4, 0.5, 0.75, 1, 1.25, 1.5, 1.75, 2, 2.5, 3, 3.5, 4, 4.5, 5, 5.5, 6, 6.5, 7mm

#### Unified Screw Pitch Gages (60°)

Range	Order No.	Composition of leaves
4 - 42 TPI	<b>188-111</b>	30 leaves: 4, 4 1/2, 5, 5 1/2, 6, 7, 8, 9, 10, 11, 11 1/2, 12, 13, 14, 15, 16, 18, 20, 22, 24, 26, 27, 28, 30, 32, 34, 36, 38, 40, 42 TPI
4 - 84 TPI	<b>950-253</b>	51 leaves: 4, 4 1/2, 5, 5 1/2, 6, 7, 8, 9, 10, 11, 11 1/2, 12, 13, 14, 15, 16, 18, 20, 22, 24, 26, 27, 28, 30, 32, 34, 36, 38, 40, 42, 44, 46, 48, 50, 52, 54, 56, 58, 60, 62, 64, 66, 68, 70, 72, 74, 76, 78, 80, 82, 84 TPI

Note: Metric and Unified Pitch Gage Set (**188-151**) is available. It consists of **188-122** (Metric) and **188-111** (Unified).

#### Metric and Unified Screw Pitch Gage Set (60°)

Range	Order No.	Composition of leaves
0.4 - 7mm / 4 - 42 TPI	<b>188-151</b>	51 leaves: Set of 188-122 and 188-111
0.5 - 6mm / 4 - 56 TPI	<b>188-152</b>	28 leaves: 4, 6, 8, 10, 11, 11-1/2, 12, 13, 16, 20, 28, 32, 40, 56 TPI 0.50, 0.75, 1.00, 1.23, 1.50, 1.75, 2.00, 2.50, 3.00, 3.50, 4.00, 4.50, 5.00, 6.00 mm

#### Whitworth Screw Pitch Gages (55°)

Range	Order No.	Composition of leaves
4 - 42 TPI	<b>188-101</b>	30 leaves: 4, 4 1/2, 5, 5 1/2, 6, 7, 8, 9, 10, 11, 11 1/2, 12, 13, 14, 15, 16, 18, 20, 22, 24, 26, 27, 28, 30, 32, 34, 36, 38, 40, 42 TPI
4 - 60 TPI	<b>188-102</b>	28 leaves: 4, 4 1/2, 5, 6, 7, 8, 9, 10, 11, 12, 13, 14, 16, 18, 19, 20, 22, 24, 25, 26, 28, 30, 32, 34, 36, 40, 48, 60 TPI

**Mitutoyo**

# Radius Gages-Sets

## SERIES 186

### FEATURES

#### Decimal Radius Gages to 1" Fractional Radius Gages to 1"

MITUTOYO Radius Gages are recommended for checking or laying out concave or convex radii. An individual gage for each dimension makes it possible to verify radius or fillet dimensions easier, faster and more accurately in machining, layout, inspection and pattern-making work. The measuring surfaces are precisely finished with smooth, accurate edges. The Radius Gages are available separately or in six handy sets. Each Radius Gage has five measuring locations, and it is identified with its particular radius dimensions. The gages have a satin or dull-chrome finish.

The Holding Cases, provided to protect the sets of Radius Gages, have indexed pockets to facilitate the selection of the proper size gage. A 4" long holder is furnished with Set No. 186-901 to make it possible to check radii in confined or hard-to-reach locations.



186-901

### SPECIFICATIONS

Order No.	No. of Leaves	Sizes	Remarks
186-901	25	1/64"–17/64" by 64ths and 9/32"–1/2" by 32nds	Holder
186-903	17	1/64"–17/64" by 64ths	
186-904	8	9/32"–1/2" by 32nds	
186-905	8	9/16"–1" by 16ths	Holder
186-906	26	.010–.030" by .005" .040–.100" by .010" .120–.300" by .020" .350–.500" by .050"	Holder
186-907	10	.550–1" by .050"	

Accuracy: ±.0016" / 0.04mm

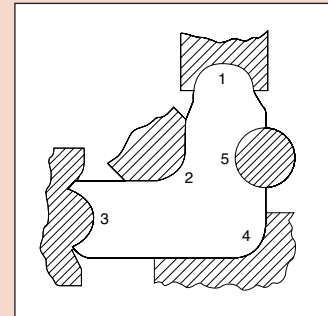

5 concave and convex radii per each leaf.

#### Decimal

Radius	Part No.	Radius	Part No.
.010"	211798	.240"	211816
.015"	211799	.260"	211817
.020"	211800	.280"	211818
.025"	211801	.300"	211819
.030"	211802	.350"	211820
.040"	211803	.400"	211821
.050"	211804	.450"	211822
.060"	211805	.500"	211823
.070"	211806	.550"	211824
.080"	211807	.600"	211825
.090"	211808	.650"	211826
.100"	211809	.700"	211827
.120"	211810	.750"	211828
.140"	211811	.800"	211829
.160"	211812	.850"	211830
.180"	211813	.900"	211831
.200"	211814	.950"	211832
.220"	211815	1.000"	211833

#### Fraction

Radius	Part No.	Radius	Part No.
1/64"	201441	5/16"	201459
1/32"	201442	11/32"	201460
3/64"	201443	3/8"	201461
1/16"	201444	13/32"	201462
5/64"	201445	7/16"	201463
3/32"	201446	15/32"	201464
7/64"	201447	1/2"	201465
1/8"	201448	9/16"	211790
9/64"	201449	5/8"	211791
5/32"	201450	11/16"	211792
11/64"	201451	3/4"	211793
3/16"	201452	13/16"	211794
13/64"	201453	7/8"	211795
7/32"	201454	15/16"	211796
15/64"	201455	1"	211797
1/4"	201456		
17/64"	201457		
9/32"	201458		



# Standard Gages

## SERIES 950

### FEATURES

- Made of high quality steel.
- Satin chrome finish.

### SPECIFICATIONS

**Inch**

Order No.	Type	Size
950-202	American Standard Wire Gage	Gage Range 0-36
950-203	U.S. Standard Wire Gage	Gage Range 0-36



950-202



950-203

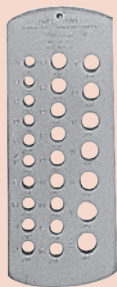

950-209



950-204

# Tap and Drill Gage

## SERIES 950

### FEATURES

- Each drill gage is marked with drill size in fractions and decimals.
- Satin chrome finish.
- Tap and drill gage shows the correct tap drill for National Fine or National Coarse thread series.
- Approximate plate size is 6-3/8" x 2-1/2" x 5/64".

### SPECIFICATIONS

**Inch/Metric**

Order No.	Type	Size
950-200	Twist Drill and Drill Rod Gage	61-80 Twist Drill and Drill Rod
950-204	Drill Gage / Mach. Screw Gage	Tap Size 2-56 to 1/4-28
950-206	Fractional Drill Gage	Drill Size 1/16" to 1/2"
950-207	Metric Drill Gage	1.5 to 12.5mm 30 holes
950-208	Metric Drill Gage	1.0 to 5.9mm 57 holes
950-209	A to Z Alphabet Drill Gage	Drill size A to Z
950-276	Twist Drill and Drill Rod Gage	1-60 Twist Drill and Drill Rod

# Drill Point Gage

## SERIES 950

### FEATURES

- For measuring properly grounded 59° drill tips.
- Rule and slide made of steel.
- Satin chrome finish.

- Slide graduated in 32nds.
- End clip is adjustable and removable.
- Versatile - Can be used as Rule, Hook Rule, Try Square, Depth Gage or Caliper, and for Layout

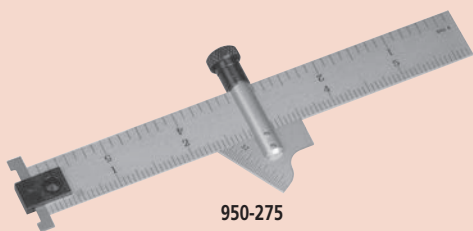

950-275

### SPECIFICATIONS

Order No.	Size	Rule Graduation
950-275	6"	1/8, 1/16, 1/32, 1/64

# Thread Gage

## SERIES 950

### FEATURES

Used for grinding and setting tools when cutting acme threads whose side have an inclination of 14-1/2° (29° included angle)

### SPECIFICATIONS

Order No.	Description
950-257	29° Acme screw thread gage



950-257

# Center Gage

## SERIES 950

### FEATURES

- Hardened with lapped edges and notches.
- Meets requirements of the American National and US 60° Standards.

- Scales with 14ths and 20ths graduations provided on one side, 24ths and 32nds on reverse side.

### SPECIFICATIONS

Inch	
Order No.	Type
950-201	Center Gage

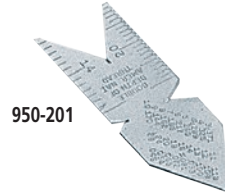

# Tap Wrench

## SERIES 985

### FEATURES

#### T-Handle Cam Lock Tap Wrenches

- Widest Range Available for Tap Size (1/8 - 1/2") (M3-M12)
- Patented Revolutionary Cam Lock System
- Quick Action Clamping for Easy Replacement
- Tap will Never Release During Use
- Heavy Duty Design for Extra Long Life
- Capable of Handling Extreme Torque
- Can Also be Used as a Hand Drill for Sizes 1/16 - 5/16"

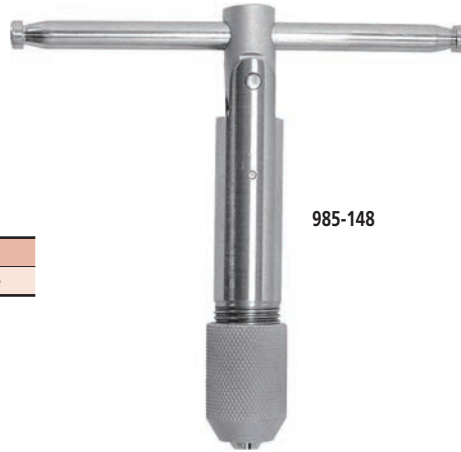

### SPECIFICATIONS

Order No.	Clamping Capacity	Remarks
985-148	1/8" - 1/2" (M3-M12)	Cam Lock Type

Patent No. 6,945,145



# Scribers

## SERIES 985

MITUTOYO provides a full line of scribers to accommodate every shop need. All the scribers, with the exception of the **985-105**, have tungsten-carbide tips. The **985-105** has a diamond tip.

### SPECIFICATIONS

Order No.	Length	Replacement Point
985-101	6.75"	No. 050561
985-102	6.12"	—
985-103	8.87"	—
985-104*	5.75"	No. 050562
985-105*	5.12"	No. 050563

\* Retractable



985-138

# Center Punches

## SERIES 985

### SPECIFICATIONS

Order No.	Length	Replacement Point	Remarks
985-112	5.25"	No. 050565	.68" (DIA), Plastic housing
985-113	6.0"	No. 050566	1.0" (DIA), Plastic housing
985-114	3.0"	—	.31" (DIA)
985-115	4.0"	—	.39" (DIA)
985-116	4.3"	—	.59" (DIA)
985-117	5.0"	—	.67" (DIA)
885-138	4.0", 1/16" dia. punch is 3"	—	5 pcs set 1/16", 5/64", 3/32", 9/64", 5/32"



985-114

985-112

985-113

# Drive Pin Punches

## SERIES 985

### SPECIFICATIONS

Order No.	Length	Remarks
985-118	8"	5pcs. Extra long Drive Pin Punch Set 1/8, 3/16, 1/4, 5/16, 3/8"
985-119	4"	8pcs. Drive Pin Punch Set 1/16, 3/32, 1/8, 5/32, 3/16, 7/32, 1/4, 5/16"
985-120	4"	8pcs. Brass Drive Pin Punch Set 1/16, 3/32, 1/8, 5/32, 3/16, 7/32, 1/4, 5/16"



985-119

# Center Finder

**SERIES 985**

## FEATURES

- Accurately and quickly locates center on round workpieces.
- Satin chrome finish

## SPECIFICATIONS

Order No.	Remarks
985-144	Center finder

- Place tool in drill chuck or collet and line up pointer with line scribed on shaft.



# Pin Vises

**SERIES 985**

## FEATURES

- Made of alloy steel, black oxide finish
- Collets grip firmly when chuck is tightened
- Knurled finger grip
- Range of Set 0 - .188"

## SPECIFICATIONS

Order No.	Remarks
985-143	4 pcs. pin vise set

- Supplied in plastic punch
- Ideal for holding small tools, rods, wires, taps, etc.

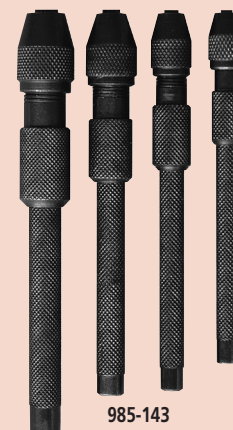

# Wiggler

**SERIES 985**

## FEATURES

- Made from precision ground tool steel
- Includes offset indicator holder and improved chuck design for holding attachments
- Attachments readily interchangeable

## SPECIFICATIONS

Order No.	Remarks
985-142	5 pcs. set

- Tool adapts to countless applications
- Attachments snap into chuck and clamp to ball swivel joint which permits adjustments to angular positions or true concentricity

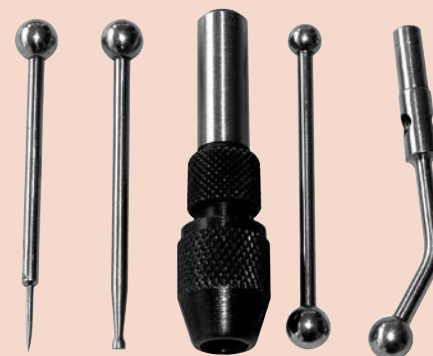

# Optical Center Punch

**SERIES 985**

## FEATURES

- Efficient, precision punching of hole centers
- Center dot & circle for targeting the punch
- Magnifies without distortion or parallax

## SPECIFICATIONS

Order No.	Remarks
985-139	9X Acrylic Lens



# Edge & Center Finders

## FEATURES

The Edge and Center Finders are hardened and ground on all surfaces.

## SPECIFICATIONS

Order No.	Shank (DIA)	Tip (DIA)	Remarks
050101	3/8" (.375")	.20"	Edge Type
050102	1/2" (.50")	.20"	Edge Type
050103	3/8" (.375")	.20"	Center Type
050104	1/2" (.50")	.20"	Center Type
050105	.375"/10mm	10mm	Edge Type
050106	10mm	10mm	Edge Type
050109	1/2" (.50")	.50"	Edge Type
050110	1/2" (.50")	.20", .50"	Double Edge Finder

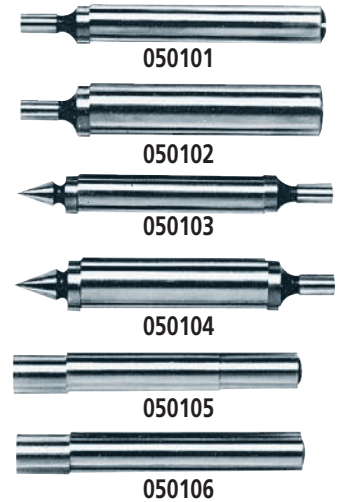

# Bench Center

## SERIES 967

### FEATURES

- Used with a dial test indicator (optional), the Bench Center provides precision measurement of concentricity verification on cylindrical workpieces.
- With an indicator clamp. (Holding stem diameter: 9.53mm / .375")

Order No.: 967-201M

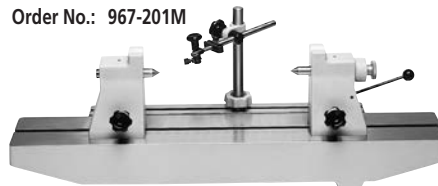

### DIMENSIONS

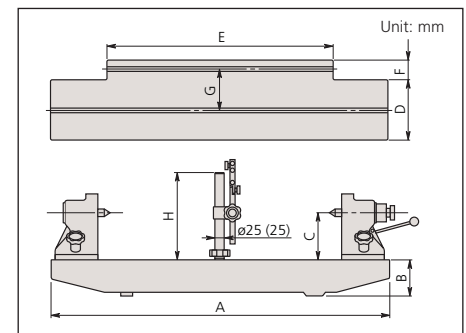

Order No.	A	B	C	D	E	F	G	H
967-203-10	310	40	50	70	178	41	60	134.5
967-201-10	500	45	75	80	370	36	60	194.5
967-204-10	700	80	100	140	500	65	110	194.5
967-202-10	900	100	125	160	600	50	104	230

### SPECIFICATIONS

Order No.	Center-to-Center	Workpiece Capacity Diameter	Max. Weight Hold	Parallelism of Centers	Flatness of Surface	Attachment Diameter	Mass (kg)
967-203-10	5.9" / 150mm	3.8"	17.5 lbs. (8kg)	.0002"	.0004"	Ø3/8"	7
967-201-10	11.8" / 300mm	5.8"	35 lbs. (16kg)	.0002"	.0006"	Ø3/8"	13
967-204-10	17.7" / 450mm	7.8"	44 lbs. (20kg)	.0002"	.0007"	Ø3/8"	60
967-202-10	23.6" / 600mm	9.8"	66 lbs. (30kg)	.00024"	.0008"	Ø3/8"	70

### Technical Data

Maximum workpiece dia.: 300mm  
 Maximum workpiece height: 150mm  
 Mass: 13kg

### Optional Accessories:

**56AAJ988** Special attachment for mounting **967-201-10** in vertical position.

**56AAJ987** Special attachment for mounting **967-203-10** in vertical position.

# Digital Protractor

## SERIES 950

### FEATURES

These Digital Protractors present inclination values on an easy-to-read liquid crystal display. The measurements are generated by an electronic gravity sensor and processed by the latest low-power electronic circuit technology.

- Full 360° range (90° x 4).
- Machined aluminum frame.
- Alternate reference (zero).
- Reading hold.
- Simple calibration requiring no special fixtures.
- Display remains upright to view at all angles. (950-317, Pro 360 Model).
- RS232C output. (950-318 Pro 3600 Model).
- Supplied in fitted carrying case.



Front View

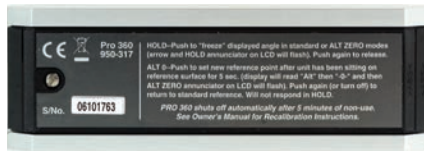

950-317 Back View



950-318 Back View

### SPECIFICATIONS

Order No.	950-317	950-318
Model	Pro 360	Pro 3600
Range	360° (90°x4)	360° (90°x4)
Resolution	0.1°	0.01° (0° to 9.99°) 0.1° (10° to 90°)
Accuracy	±0.1° Level ±10°, Plumb ±10° ±0.2° Maximum error	±0.05° (0° to 10°) ±0.1° (80° to 90°) ±0.2° (10° to 80°)
Repeatability	±0.1°	±0.05°
Cross Axis Error	Minimal	Minimal
Battery Life	500 Hrs. Standard 9-Volt Battery	500 Hrs. Standard 9-Volt Battery
Temperature Operation	-5°C to 50°C (23° to 122°F)	-5°C to 50°C (23° to 122°F)
Storage	-20°C to 65°C (-4°F to 149°F)	-20°C to 65°C (-4°F to 149°F)
Weight	289g (10.2oz.)	295g (10.4oz.)
Output	N/A	RS-232C Compatible
Standard Accessories	Plastic Case	Plastic Case

±Represents clockwise or counter-clockwise slope.

### DIMENSIONS

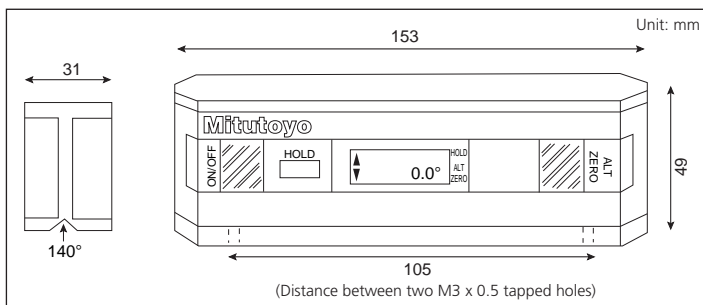

### Optional Accessories

- 64PPP795 Magnetic base
- 50AAA983A RS-232C Output cable w/foot switch

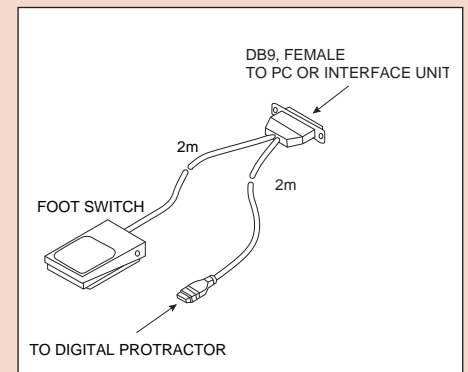

50AAA983A RS-232C Output cable w/foot switch 10P-25P

# Digital Hand Tachometers

## SERIES 982

### FEATURES

- New Digital Hand Tachometers are compact and easy to handle.
- NIST Certification is supplied with each Digital Hand Tachometer.
- Model PH-200LC (982-552) has laser Diode Detection and a combination of Contact and Non-Contacts measurement.
- Supplied with plastic carrying case.



982-551



982-552

### DIMENSIONS

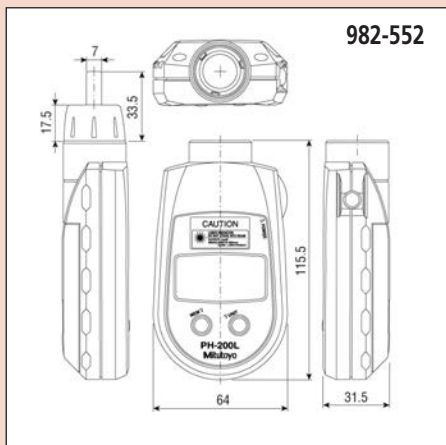
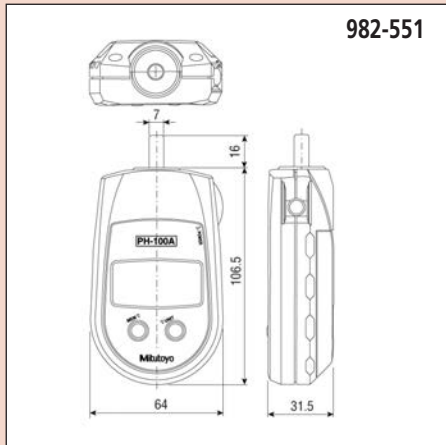

### SPECIFICATIONS

Order No.	982-551	982-552
Model No.	PH-100A	PH-200LC
Revolution per minute	1.0 – 25,000 rpm	—
Rotation speed	—	Non-contact: 6.0 – 99,999 rpm; Contact: 6.0 – 25,000 rpm
Measuring accuracy Revolution Surface, Speed, Length	1.0 – 599.9rpm: ±1rpm, 600.0 – 25,000 rpm: ±0.006% and ±0.5 digit ±0.4% and 1 digit	6.0 – 599.9 rpm: ±1rpm, 600.0 – 99,999 rpm ±0.006% and ±0.5 digit ±0.4% and ±1 digit
Detection	Optical coupler, 20 pulses per revolution	Laser diode
Outside dimensions	4.83" L x 2.52" W x 1.24" H (122.5mm x 64mm x 31.5mm)	4.55" L x 2.52" W x 1.24" H Overall length with contact adapter: 149mm
Mass	170 g	160 g
Power	Battery: AA 3 pcs.	Battery: AA 3 pcs.

### Optional Accessories For Digital Hand Tachometers

Order No.	Description	Dimension	Drawing
010049	Cone Adapter, Standard	D = 1/2"	
010050	Cone Adapter, 5/8"	D = 5/8"	
010051	Cone Adapter, 3/4"	D = 3/4"	
010052	Cone Adapter, 1-1/4"	D = 1-1/4" d = 1/2"	
010053	Funnel Adapter, Standard	D = 1/2"	
010054	Funnel Adapter, 3/4"	D = 3/4"	
010055	Measuring Wheel FPM (6" cir), Standard	D = 1.91"	
010056	Measuring Wheel FPM (12" cir)	D = 3.82"	
010057	Measuring Wheel YPM (0.1 yard cir)	D = 1.15"	
010058	Measuring Wheel MPM (0.1 meter cir)	D = 1.25"	
010059	Reflective Tabs 1/2" square (35 pcs)		
010060	Extension Shaft (3" length)		

# Granite Surface Plate Accessories

## SERIES 517

These accessories made from the same high quality black granite as Mitutoyo surface plates, allow extra flexibility in work holding and positioning.

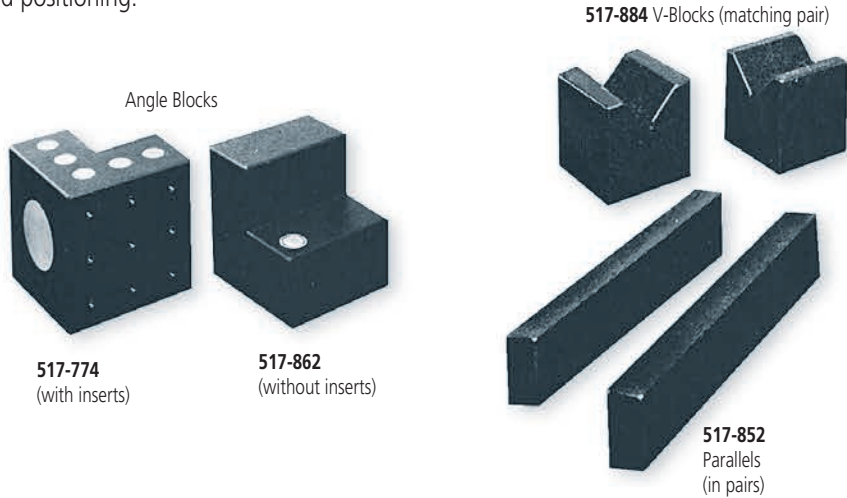

## SPECIFICATIONS

### Angle Blocks with or without inserts

Grade	Laboratory*			Master**			Case
	2 Face	4 Face		2 Face	4 Face		
		no inserts	w/ inserts		no inserts	w/ inserts	
4 x 4 x 4"	<b>517-767</b>	<b>517-761</b>	<b>517-773</b>	<b>517-867</b>	<b>517-861</b>	<b>517-873</b>	<b>050021</b>
6 x 6 x 6"	<b>517-768</b>	<b>517-762</b>	<b>517-774</b>	<b>517-868</b>	<b>517-862</b>	<b>517-874</b>	<b>050022</b>

\*Laboratory overall accuracy: .000025" per 6".

\*\*Master overall accuracy: .000050" per 6".

### Parallels Pair

Grade	Accuracy	Laboratory		Master			Case
		2 Face	4 Face	Accuracy	2 Face	4 Face	
.75 x 1 x 6"	.00003"	<b>517-755</b>	<b>517-750</b>	.00006"	<b>517-855</b>	<b>517-850</b>	<b>050027</b>
.75 x 1.5 x 9"	.00004"	<b>517-756</b>	<b>517-751</b>	.00008"	<b>517-856</b>	<b>517-851</b>	<b>050028</b>
1 x 2 x 12"	.00006"	<b>517-757</b>	<b>517-752</b>	.0001"	<b>517-857</b>	<b>517-852</b>	<b>050029</b>

### V-Blocks Matching Pair

V-1 type have matching accuracy on "V" from the bottom face only.

V-5 type have four face matching accuracy plus "V".

Grade	Laboratory*		Master**		Case
	V-1	V-5	V-1	V-5	
2 x 2 x 2.5"	<b>517-787</b>	<b>517-783</b>	<b>517-887</b>	<b>517-883</b>	<b>050039</b>
3 x 3 x 3"	<b>517-788</b>	<b>517-784</b>	<b>517-888</b>	<b>517-884</b>	<b>050040</b>
6 x 6 x 6"	<b>517-789</b>	<b>517-785</b>	<b>517-889</b>	<b>517-885</b>	<b>050022X2</b>

\*Laboratory overall accuracy: .00005" per 6".

\*\*Master overall accuracy: .0001" per 6"



# Black Granite Surface Plate

## SERIES 517

### FEATURES

- Natural granite seasoned for thousands of years is free from deterioration or dimensional change over time.
- Granite surface plate has many advantages over cast iron surface plates:  
Twice as hard as cast iron.  
Minimal changes in dimension due to temperature changes.  
Free from wringing, so there is no interruption of work.  
Free from burrs or protrusions because of the fine grain structure and insignificant

- stickiness; this ensures a high degree of flatness over a long service life and causes no damage to other parts or instruments.
- Trouble-free operation for use with magnetic materials.
- Long life and rust-free, resulting in low maintenance costs.
- MITUTOYO Granite Surface Plates meet or exceed Federal Specification GGG-P-463c. Each Surface Plate is shipped with a Certificate of Accuracy which guarantees its accuracy and verifies its traceability to the National Institute of Standards and Technology.
- All plates from 48" x 108" and larger are Machine Base Gray Granite. Smaller plates are Black Granite.
- Surface Plates, to size of specifications other than standard, available on special order.
- Surface Plates, with the bolt screws, available on special order.
- All MITUTOYO Surface Plates shipped F.O.B. Escondido, California.

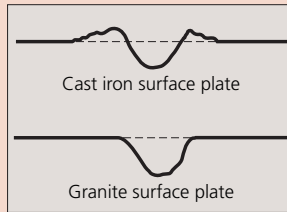

### SPECIFICATIONS

**Inch** 100 lbs.-Load / sq. ft. no ledge

Size	AA Laboratory Grade				A Inspection Grade				B Shop Grade			
	H	Acc.	Order No.	Wt.	H	Acc.	Order No.	Wt.	H	Acc.	Order No.	Wt.
8 x 12"	3"	50	517-700	30	2"	100	517-800	25	2"	200	517-900	25
9 x 12"	3"	50	517-701	40	3"	100	517-801	40	2"	200	517-901	30
12 x 12"	3"	50	517-702	50	3"	100	517-802	50	3"	200	517-902	50
12 x 18"	4"	50	517-703	100	4"	100	517-803	100	4"	200	517-903	100
18 x 18"	4"	50	517-704	150	4"	100	517-804	150	3"	200	517-904	100
18 x 24"	4"	65	517-705	200	4"	130	517-805	200	4"	260	517-905	200
24 x 24"	5"	70	517-706	310	4"	140	517-806	259	3"	280	517-906	200
24 x 30"	5"	75	517-707	400	5"	150	517-807	400	4"	300	517-907	300
24 x 36"	6"	85	517-708	600	5"	170	517-808	500	4"	340	517-908	400
24 x 48"	8"	150	517-709	1000	6"	300	517-809	800	5"	600	517-909	650
30 x 36"	6"	100	517-710	800	5"	200	517-810	600	5"	400	517-910	600
30 x 48"	8"	150	517-711	1300	6"	300	517-811	1000	6"	600	517-911	1000
30 x 60"	12"	200	517-712	1900	10"	500	517-812	1535	8"	1000	517-912	1150
36 x 36"	6"	100	517-713	900	5"	200	517-813	780	5"	400	517-913	700
36 x 48"	8"	150	517-714	1500	6"	300	517-814	1200	6"	600	517-914	1200
36 x 60"	12"	200	517-715	2850	10"	400	517-815	2350	8"	800	517-915	1900
36 x 72"	12"	250	517-716	3400	10"	500	517-816	2850	8"	1000	517-916	2300
48 x 48"	8"	200	517-717	2025	6"	400	517-817	1525	6"	800	517-917	1500
48 x 60"	12"	250	517-718	3800	10"	500	517-818	3150	8"	1000	517-918	2525
48 x 72"	12"	300	517-719	4500	10"	600	517-819	3800	8"	1200	517-919	3050
48 x 84"	14"	350	517-720	6150	12"	700	517-820	5325	10"	1400	517-920	4450
48 x 96"	14"	400	517-721	7000	12"	800	517-821	6050	10"	1600	517-921	5150
48 x 108"	14"	500	517-722	7900	12"	1000	517-822	6830	10"	2000	517-922	5700
48 x 120"	18"	700	517-723	11300	16"	1400	517-823	10160	14"	2800	517-923	8800
48 x 144"	18"	800	517-724	13500	16"	1600	517-824	12200	14"	3200	517-924	10500
60 x 60"	14"	250	517-725	5500	12"	500	517-825	4800	10"	1000	517-925	4000
60 x 72"	14"	350	517-726	6600	12"	700	517-826	5750	10"	1400	517-926	4900
60 x 96"	14"	500	517-727	8800	12"	1000	517-827	7600	10"	2000	517-927	6500
60 x 120"	16"	700	517-728	11050	14"	1400	517-828	11100	12"	2800	517-928	9800
60 x 144"	18"	900	517-729	16950	16"	1800	517-829	15100	14"	3600	517-929	14200
72 x 72"	14"	400	517-730	8000	12"	800	517-830	7000	10"	1600	517-930	5700
72 x 96"	16"	500	517-731	12025	14"	1000	517-831	10800	12"	2000	517-931	9200
72 x 120"	16"	700	517-732	15070	14"	1400	517-832	13400	12"	2800	517-932	11400
72 x 144"	18"	1000	517-733	20300	16"	2000	517-833	18100	14"	4000	517-933	15900

**Inch** 50 lbs.-Load / sq. ft. no ledge

Size	AA Laboratory Grade				A Inspection Grade				B Shop Grade			
	H	Acc.	Order No.	Wt.	H	Acc.	Order No.	Wt.	H	Acc.	Order No.	Wt.
8 x 12"	2"	50	<b>517-740</b>	25	2"	100	<b>517-840</b>	25	2"	200	<b>517-940</b>	25
12 x 18"	3"	50	<b>517-741</b>	80	3"	100	<b>517-841</b>	80	2"	200	<b>517-941</b>	60
18 x 24"	4"	65	<b>517-742</b>	200	3"	130	<b>517-842</b>	165	2"	260	<b>517-942</b>	100
24 x 36"	5"	85	<b>517-743</b>	500	4"	170	<b>517-843</b>	400	3"	340	<b>517-943</b>	300
36 x 48"	6"	150	<b>517-746</b>	1200	5"	300	<b>517-846</b>	1000	4"	600	<b>517-946</b>	800

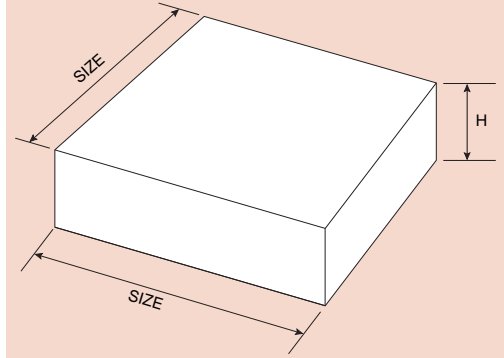

## Steel Stands

Steel Stands for supporting Black Granite Surface Plates, at working levels, are available either stationary or with casters. Sizes and weights are given below.



### SPECIFICATIONS

Size	Stationary		With Casters	
	Order No.	Wt.	Order No.	Wt.
12 x 18"	<b>517-950</b>	42lbs	<b>517-950-1</b>	46lbs
18 x 18"	<b>517-951</b>	46lbs	<b>517-951-1</b>	50lbs
18 x 24"	<b>517-952</b>	50lbs	<b>517-952-1</b>	56lbs
24 x 24"	<b>517-954</b>	65lbs	<b>517-954-1</b>	69lbs
24 x 30"	<b>517-955</b>	70lbs	<b>517-955-1</b>	74lbs
24 x 36"	<b>517-956</b>	73lbs	<b>517-956-1</b>	77lbs
24 x 48"	<b>517-957</b>	90lbs	<b>517-957-1</b>	94lbs
30 x 36"	<b>517-960</b>	85lbs	<b>517-960-1</b>	89lbs
30 x 48"	<b>517-961</b>	95lbs	<b>517-961-1</b>	99lbs
30 x 60"	<b>517-962</b>	105lbs	<b>517-962-1</b>	109lbs
36 x 36"	<b>517-963</b>	95lbs	<b>517-963-1</b>	99lbs
36 x 48"	<b>517-964</b>	105lbs	<b>517-964-1</b>	109lbs
36 x 60"	<b>517-965</b>	160lbs	<b>517-965-1</b>	164lbs
36 x 72"	<b>517-966</b>	180lbs	<b>517-966-1</b>	184lbs
48 x 48"	<b>517-967</b>	190lbs	<b>517-967-1</b>	194lbs
48 x 60"	<b>517-968</b>	200lbs	<b>517-968-1</b>	204lbs
48 x 72"	<b>517-969</b>	205lbs	<b>517-969-1</b>	209lbs
48 x 84"	<b>517-970</b>	320lbs	<b>517-970-1</b>	324lbs
48 x 96"	<b>517-971</b>	335lbs	<b>517-971-1</b>	339lbs
48 x 108"	<b>517-972</b>	350lbs	<b>517-972-1</b>	354lbs
48 x 120"	<b>517-973</b>	365lbs	<b>517-973-1</b>	369lbs
48 x 144"	<b>517-974</b>	430lbs	<b>517-974-1</b>	434lbs
60 x 60"	<b>517-975</b>	245lbs		
60 x 72"	<b>517-976</b>	340lbs		
60 x 96"	<b>517-977</b>	375lbs		
60 x 120"	<b>517-978</b>	455lbs		
60 x 144"	<b>517-979</b>	480lbs		
72 x 72"	<b>517-980</b>	380lbs		
72 x 96"	<b>517-981</b>	465lbs		
72 x 120"	<b>517-982</b>	510lbs		
72 x 144"	<b>517-983</b>	530lbs		

Note: The total height of stand and granite plate is 36". If ordering only stand, stand height will be made according to a Grade A granite plate thickness.