



A Full Line Up of Powerful Servos to Meet the Demands of Your Application!

Compumotor began manufacturing brushless servo motors with the release of the SM series in the spring of 1995. Since that time, we have continued to expand our product offering and have manufacturing plants in California and Italy.

Innovation in Design

Compumotor utilizes two distinct technologies in the manufacturing of brushless servo motors. The Slotless Design and the Bridged Stator Design both reduce motor manufacturing costs while providing performance advantages to the user.

The slotless design eliminates all detent torque in the motor, providing superior performance in applications requiring smooth, low speed operation. This design also results in higher rotor inertia, providing an advantage in applications involving high inertia loads.

The bridged stator design results in extremely high torque-to-

inertia ratios, providing a performance advantage in applications requiring high accelerations. The bridged stator design also greatly reduces detent torque and mechanical noise when compared to a conventional slotted motor.

Compumotor can also provide an integrated planetary gearhead for use with our brushless servo motors. Our unique design integrates the pinion of the gearhead into the motor shaft, reducing total package length by almost two inches.

Standards or Specials in 10 Days

Compumotor's brushless servo motors are manufactured in our modern JIT manufacturing facility. Highly evolved manufacturing philosophies provide levels of service and product availability previously unattainable in the servo motor industry.

Compumotor's lead times average less than ten days for all standard and custom servo motors.

SM Series



- Size 16 and 23
- 0.8 to 11.3 in-lb. continuous torque
- Slotless design
- Rugged housing (IP65 option)
- Connection options

SE Series



- Size 16 and 23
- 0.8 to 10.1 in-lb. continuous torque
- Slotless design
- Plastic encoder cover
- Short package length

BE Series



- Size 16, 23 and 34
- 1.4 to 46 in-lb. continuous torque
- Bridged stator design
- 2000-line encoder standard
- Connection options

M Series



- Size 105, 145 and 205mm
- Up to 90 Nm of power
- Brushless construction
- Encoder feedback and resolver

Planetary Gearheads



- Size 16, 23, 34 and 92
- Integrated pinion design
- Shortest package length available

NeoMetric & J Series



- 70 mm and 92 mm
- 6 to 61 in-lb. continuous torque
- Bridged stator design
- Rugged housing (IP65 option)
- Connection options

SL Series



- Size 42, 63, 102 and 140mm
- 20 to 350 lbs continuous force
- Slotless design
- High speeds
- High precision

Custom Designed Servo Motors for Your Specific Application!

Compumotor offers a broad range of standard options with all of our brushless servo motor families. Our numerous shaft, feedback and connection options will fulfill the needs of most of our customers. However, we realize that from time to time the need arises to have a custom motor designed specially for your application.

Whether you need custom connectors, mounting, or a custom winding, Compumotor can build a motor designed to your exact specifications. Compumotor provides these special designs for our customers with:

- Minimal impact on product lead time
- Modest impact on pricing
- No minimum quantities

Compumotor's modern manufacturing system allows us to offer custom motor solutions without sacrificing product quality and availability. All of our custom motors are built in our standard servo motor work cell, and our computerized custom product tracking system allows us to provide consistent, high-quality custom products. And, because custom motor manufacturing is integrated into our standard manufacturing process, we can often build and ship custom designed motors and cables in the same time frame as standard products.

Compumotor provides this service for one simple reason: to make it easier for you, our customer, to integrate a Compumotor servo motor into your application. We provide more than just a component, we provide a custom designed servo motor solution.

Common Special Requests

Connectorization

- Right angle connector housing
- MS connectors on back cover
- Special cable lengths
- Hi-flex cables
- Customer specified cables and connectors
- Cable exiting through back cover

Flanges

- Tapped mounting holes
- Customer specified flanges
- Face mount

Gearheads

- Non-standard ratios
- Customer specified flanges
- Customer specified output shaft

Windings:

- Specific bus voltage

Brakes

- Internal or external

Feedback

- Higher resolution encoders
- Higher temperature encoders

Shafts

- Special lengths
- Special flats
- Special keyways
- Special shaft diameters
- Metric shaft diameters
- Hollow shafts
- Rear Shaft Extension
- Double flats
- Shaft pinning
- Pressed on gears
- Center tapped
- Special shaft materials

Miscellaneous Options

- Private label back cover
- Special windings
- Shorter lengths
- High speed balancing
- Special finish

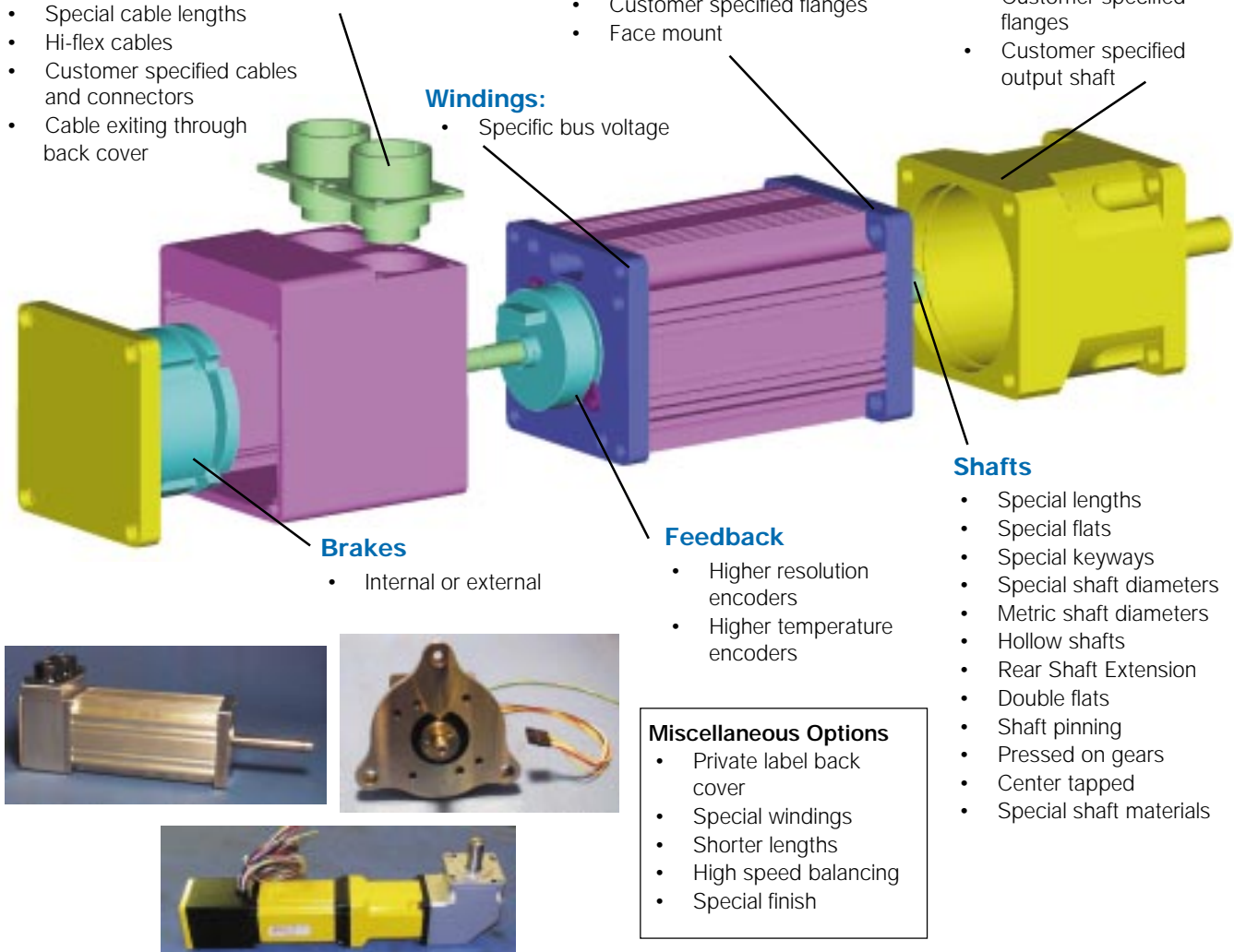

Custom Designed Servo Motors For Your Specific Application. Call 1-800-358-9070 Today.

NeoMetric & J Series Motors



Innovative Bridged Stator Design

The NeoMetric and J Series brushless servo motors feature a bridged stator design. This state-of-the-art motor design establishes industry-leading torque to inertia ratios in a very compact package size.

The bridged stator construction also reduces audible noise generated by the motor. Conventional motor designs allow magnetic forces to act upon the stator teeth, creating movement in them much like a cantilever beam. The “bridges” between the teeth in the NeoMetric design effectively stiffen the teeth, reducing movement.

This same design principle also allows advanced manufacturing techniques. The two-piece stator lamination of the bridged stator design allows the slot opening, traditionally on the inside diameter, to be transferred to the outside diameter, simplifying winding insertion.

The NeoMetric Series brushless servo motors provide extremely high torque to inertia ratios. For applications involving a high inertial load, a larger rotor inertia may be desirable. The J Series motors were designed specifically for these types of applications. The J Series motors provide the same performance as the NeoMetric Series, but feature a higher rotor inertia.

The size 34 NeoMetric Series and J Series servo motors are available with integrated planetary gearheads in ratios up to 100:1. Our unique package integrates the gearhead pinion into the motor shaft, reducing the overall package length by up to 2 inches.

Features

- 70mm, 92mm, and size 34
- 6 to 61 lb-in continuous torque
- Brushless construction
- High torque density packaging
- Outstanding torque-to-inertia ratios
- Bridged stator design - quiet operation
- High performance neodymium magnets
- Thermoswitch protection
- TENV housing, IP65 option
- Resolver, encoder, Hall feedback options
- 10-day deliveries
- Two year warranty
- CAD (.dxf) drawings available
- CE Compliant

Part Numbering System

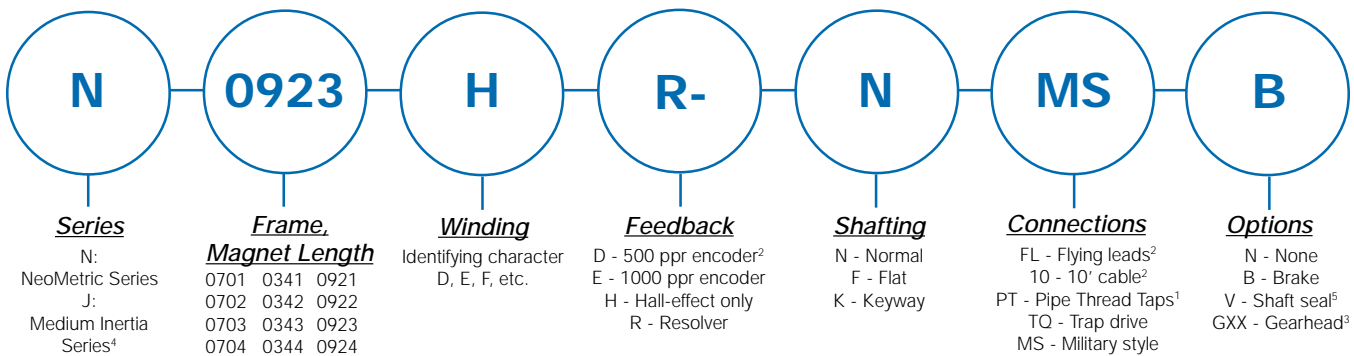

1 92 mm motors only
 2 70mm and 34 frame only
 3 34 & 92 frame motors only. Specify "K" shaft option with gearheads

4 Four stack motor lengths not available with J Series
 5 With MS or TQ connectors, IP65.

70 mm or Size 34, Encoder Feedback, Specifications*

Parameter	Symbol	Units	N0701D	N0701F	N0702E	N0702F	N0703F	N0703G	N0704F	N0704G
			N0341D	N0341F	N0342E	N0342F	N0343F	N0343G	N0344F	N0344G
Stall Torque Continuous ¹	T_{cs}	lb-in	5.7	5.6	10.4	10.4	15.8	15.8	19.5	19.5
		oz-in	91	90	167	166	252	252	311	312
		Nm	0.63	0.63	1.17	1.16	1.77	1.77	2.18	2.19
Stall Current Continuous ^{1,4,8}	$I_{cs}(\text{sine})$	Amps Peak	3.3	5.2	3.8	5.4	5.2	7.3	5.4	7.5
Stall Current Continuous ^{1,7}	$I_{cs}(\text{trap})$	Amps DC	2.9	4.5	3.3	4.6	4.5	6.3	4.7	6.5
Peak Torque ⁶	T_{pk}	lb-in	17.0	16.8	31.2	31.1	47.3	47.3	58.4	58.6
		oz-in	272	269	500	498	757	757	934	937
		Nm	1.90	1.88	3.50	3.49	5.30	5.30	6.54	6.56
Peak Current ^{4,6,8}	$I_{pk}(\text{sine})$	Amps Peak	10.0	15.6	11.5	16.1	15.7	21.9	16.3	22.6
Peak Current ^{6,7}	$I_{pk}(\text{trap})$	Amps DC	8.7	13.5	10.0	13.9	13.6	19.0	14.1	19.6
Rated Speed ²	ω_r	rpm	7500	7500	7500	7500	6800	7500	5500	7500
Current @ Rated Speed	$I_r(\text{sine})$	Amps	3.0	4.7	3.2	4.5	4.4	5.8	4.6	5.6
Current @ Rated Speed	$I_r(\text{trap})$	Amps	2.6	4.1	2.8	3.9	3.8	5.0	4.0	4.9
Torque @ Rated Speed	T_r	lb-in	4.7	4.6	7.1	7.9	10.8	11.4	14.1	12.6
		oz-in	75	74	114	126	173	182	226	201
		Nm	0.53	0.52	0.80	0.88	1.21	1.27	1.58	1.41
Shaft Power @ Rated Speed	P_o	watts	416	411	632	699	870	1010	919	1115
Voltage Constant ^{3,4}	K_b	Volts/rad/s	0.221	0.140	0.353	0.253	0.392	0.282	0.468	0.338
Voltage Constant ^{3,4}	K_e	Volts/KRPM	23.14	14.66	36.97	26.49	41.05	29.53	49.01	35.40
Torque Constant ⁹	$K_t(\text{sine})$	oz-in/Amp Peak	27.10	17.17	43.29	31.03	48.07	34.58	57.39	41.45
		Nm/Amp Peak	0.190	0.120	0.303	0.217	0.336	0.242	0.402	0.290
		oz-in/Amp DC	31.29	19.82	49.98	35.82	55.51	39.93	66.27	47.86
Torque Constant ^{3,4}	$K_t(\text{trap})$	Nm/Amp DC	0.219	0.139	0.350	0.251	0.389	0.280	0.464	0.335
Resistance ³	R	Ohms	5.52	2.27	5.22	2.70	3.36	1.74	3.47	1.80
Inductance ⁵	L	mH	12.98	5.23	15.80	8.16	12.13	6.30	14.50	7.55
Maximum Bus Voltage	V_m	Volts DC	340	340	340	340	340	340	340	340
Thermal Res Wind-Amb	R_{th-w-a}	°C/watt	1.44	1.44	1.15	1.15	0.96	0.96	0.87	0.87
Motor Constant	K_m	oz-in/ $\sqrt{\text{watt}}$	13.32	13.16	21.88	21.80	30.28	30.27	35.57	35.67
		Nm/ $\sqrt{\text{watt}}$	0.093	0.092	0.153	0.153	0.212	0.212	0.249	0.250
Viscous Damping	B	oz-in/Krpm	0.2	0.2	0.4	0.4	0.6	0.6	0.8	0.8
		Nm/krpm	1.4 E-3	1.4 E-3	2.8 E-3	2.8 E-3	4.2 E-3	4.2 E-3	5.6 E-3	5.6 E-3
Static Friction	T_f	oz-in	0.8	0.8	1.6	1.6	2.4	2.4	3.2	3.2
		Nm	5.6 E-3	5.6 E-3	1.2 E-2	1.2 E-2	1.7 E-2	1.7 E-2	2.2 E-2	2.2 E-2
Motor Thermal Time Constant	τ_{th}	minutes	16.6	16.6	21.7	21.7	22.5	22.5	23.3	23.3
Electrical Time Constant	τ_{elec}	milliseconds	2.35	2.30	3.03	3.02	3.61	3.62	4.18	4.19
NeoMetric Mech. Time Const.	τ_{mch}	milliseconds	1.6	1.7	0.6	0.6	0.6	0.6	0.6	0.6
J Series Mech. Time Const.	τ_{mch}	milliseconds	14.7	14.7	5.7	5.7	3.2	3.2	N/A	N/A
Intermittent Torque Duration ¹⁰	T_{2x}	seconds	22	22	32	32	39	39	38	38
Peak Torque Duration ¹¹	T_{3x}	seconds	9	9	11	11	13	13	12	12
NeoMetric Rotor Inertia	J	lb-in-sec ²	1.1 E-4	1.1 E-4	1.7 E-4	1.7 E-4	2.4 E-4	2.4 E-4	3.1 E-4	3.1 E-4
		kg-m ²	1.2 E-5	1.2 E-5	2.0 E-5	2.0 E-5	2.7 E-5	2.7 E-5	3.5 E-5	3.5 E-5
J Series Rotor Inertia	J	lb-in-sec ²	1.1 E-3	1.1 E-3	1.2 E-3	1.2 E-3	1.3 E-3	1.3 E-3	N/A	N/A
		kg-m ²	1.3 E-4	1.3 E-4	1.4 E-4	1.4 E-4	1.5 E-4	1.5 E-4	N/A	N/A
Number of Poles	Np		4	4	4	4	4	4	4	4
NeoMetric Weight	#	lbs	3.5	3.5	4.5	4.5	6.0	6.0	7.3	7.3
		kg	1.6	1.6	2.1	2.1	2.7	2.7	3.3	3.3
J Series Weight	#	lbs	4.4	4.4	5.4	5.4	6.9	6.9	N/A	N/A
		kg	2.0	2.0	2.5	2.5	3.1	3.1	N/A	N/A
Winding Class			H	H	H	H	H	H	H	H

* NeoMetric and J Series Specifications are identical unless otherwise noted.
¹ @ 25°C ambient, 125°C winding temperature, motor connected to a 10"x10"x1/4" aluminum mounting plate.
² @ 40°C ambient derate phase currents and torques by 12%. Maximum speed is 7500 RPM. For higher speed operation please call the factory.
³ Measured Line to Line, +/- 10%.
⁴ Value is measured peak of sine wave.
⁵ +/- 30%. Line-to-Line, inductance bridge measurement @ 1KHz.
⁶ Initial winding temperature must be 60°C or less before peak current is Applied.
⁷ DC current through a pair of motor phases of a trapezoidally (six state) commutated motor.
⁸ Peak of the sinusoidal current in any phase for a sinusoidally commutated motor.
⁹ Total motor torque per peak of the sinusoidal amps measured in any phase, +/- 10%.
¹⁰ Maximum time duration with 2 times rated current applied with initial winding temp at 60°C.
¹¹ Maximum time duration with 3 times rated current applied with initial winding temp at 60°C.

Note: These specifications are based on theoretical motor performance and are not specific to any amplifier.

Custom Designed Servo Motors For Your Specific Application. Call 1-800-358-9070 Today.

70mm or Size 34, Resolver Feedback, Performance Curves

(Neometric & J Series data are identical unless otherwise noted)

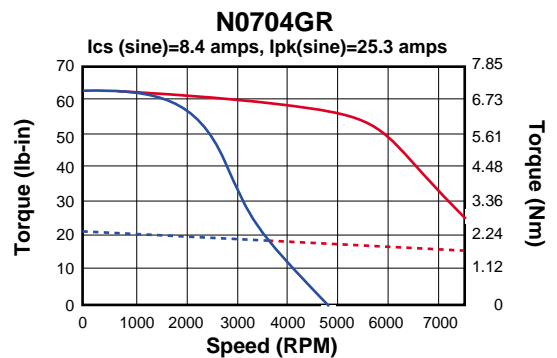
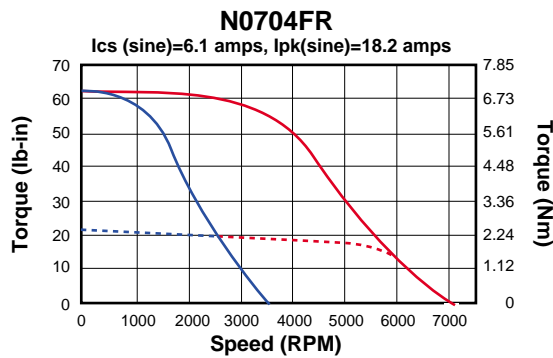
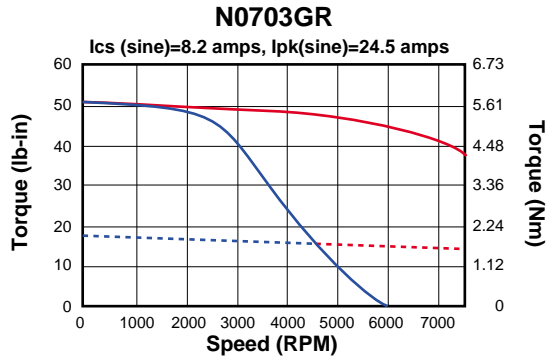
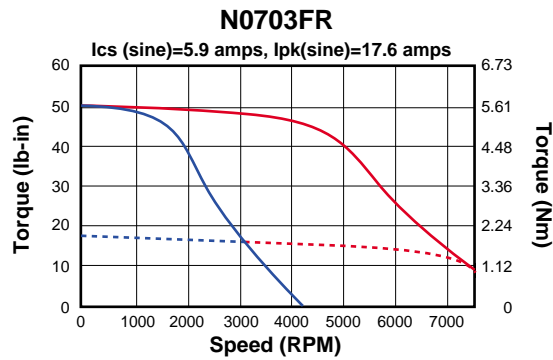
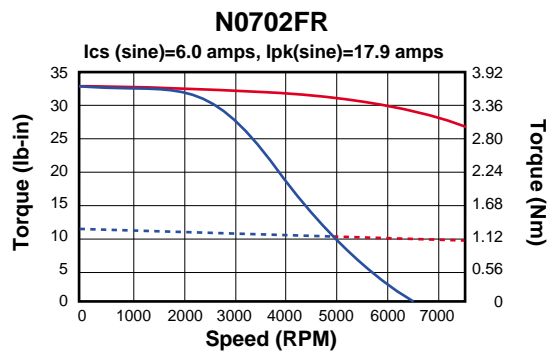
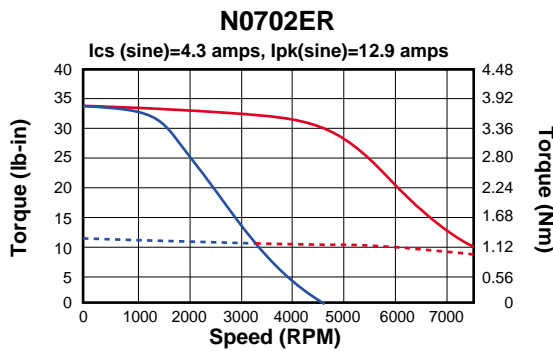
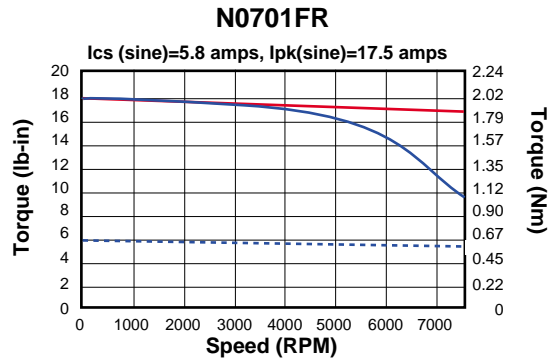
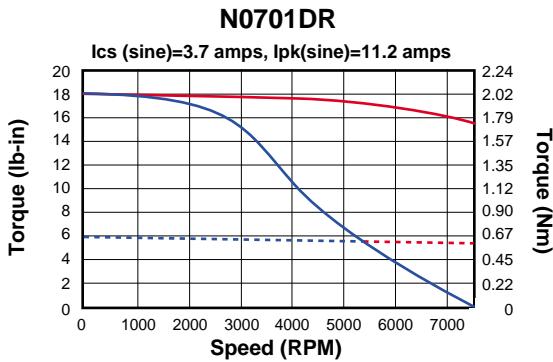

----- ——— ----- ———
 CONTINUOUS PEAK CONTINUOUS PEAK
 170 VDC 340 VDC

70 mm or Size 34, Resolver Feedback, Specifications*

Parameter	Symbol	Units	N0701D	N0701F	N0702E	N0702F	N0703F	N0703G	N0704F	N0704G	
			N0341D	N0341F	N0342E	N0342F	N0343F	N0343G	N0344F	N0344G	
Stall Torque Continuous ¹	T_{cs}	lb-in	6.3	6.3	11.6	11.6	17.6	17.6	21.8	21.8	
		oz-in	101	100	186	186	282	282	348	349	
		Nm	0.71	0.70	1.30	1.30	1.97	1.97	2.44	2.44	
Stall Current Continuous ^{1,4,7}	$I_{cs}(\text{sine})$	Amps Peak	3.7	5.8	4.3	6.0	5.9	8.2	6.1	8.4	
		Peak Torque ⁶	T_{pk}	19.0	18.8	34.9	34.8	52.9	52.9	65.3	65.4
				oz-in	304	300	559	557	846	846	1045
		Nm	2.13	2.10	3.91	3.90	5.92	5.92	7.32	7.33	
Peak Current ^{4,6,7}	$I_{pk}(\text{sine})$	Amps Peak	11.2	17.5	12.9	17.9	17.6	24.5	18.2	25.3	
Rated Speed ²	ω_r	rpm	7500	7500	7100	7500	6600	7500	5500	7500	
Current @ Rated Speed	$I_r(\text{sine})$	Amps	3.5	5.4	3.8	5.2	5.1	6.9	5.4	6.8	
Torque @ Rated Speed	T_r	lb-in	5.4	5.3	8.6	9.3	12.8	13.6	16.1	15.0	
		oz-in	86	85	138	149	205	217	257	240	
		Nm	0.60	0.60	0.97	1.04	1.44	1.52	1.80	1.68	
Shaft Power @ Rated Speed	P_o	watts	477	472	725	827	1001	1204	1045	1331	
Voltage Constant ^{3,4}	K_b	Volts/rad/s	0.221	0.140	0.353	0.253	0.392	0.282	0.468	0.338	
Voltage Constant ^{3,4}	K_e	Volts/KRPM	23.14	14.66	36.97	26.49	41.05	29.53	49.01	35.40	
Torque Constant ⁸	$K_t(\text{sine})$	oz-in/Amp Peak	27.10	17.17	43.29	31.03	48.07	34.58	57.39	41.45	
		Nm/Amp Peak	0.190	0.120	0.303	0.217	0.336	0.242	0.402	0.290	
Resistance ³	R	Ohms	5.52	2.27	5.22	2.70	3.36	1.74	3.47	1.80	
Inductance ⁵	L	mH	12.98	5.23	15.80	8.16	12.13	6.30	14.50	7.55	
Maximum Bus Voltage	Vm	Volts DC	340	340	340	340	340	340	340	340	
Thermal Res Wind-Amb	$R_{th} w-a$	°C/watt	1.44	1.44	1.15	1.15	0.96	0.96	0.87	0.87	
Motor Constant	K_m	oz-in/√watt	13.32	13.16	21.88	21.80	30.28	30.27	35.57	35.67	
		Nm/√watt	0.093	0.092	0.153	0.153	0.212	0.212	0.249	0.250	
Viscous Damping	B	oz-in/Krpm	0.2	0.2	0.4	0.4	0.6	0.6	0.8	0.8	
		Nm/krpm	1.4 E-3	1.4 E-3	2.8 E-3	2.8 E-3	4.2 E-3	4.2 E-3	5.6 E-3	5.6 E-3	
Static Friction	T_f	oz-in	0.8	0.8	1.6	1.6	2.4	2.4	3.2	3.2	
		Nm	5.6 E-3	5.6 E-3	1.2 E-2	1.2 E-2	1.7 E-2	1.7 E-2	2.2 E-2	2.2 E-2	
Motor Thermal Time Constant	τ_{th}	minutes	16.6	16.6	21.7	21.7	22.5	22.5	23.3	23.3	
Electrical Time Constant	τ_{elec}	millisecs	2.35	2.30	3.03	3.02	3.61	3.62	4.18	4.19	
NeoMetric Mech. Time Constant	τ_{mch}	millisecs	1.6	1.7	0.9	0.9	0.6	0.6	0.6	0.6	
J Series Mech. Time Constant	τ_{mch}	millisecs	14.7	14.7	5.7	5.7	3.2	3.2	N/A	N/A	
Intermittent Torque Duration ⁹	T_{2x}	seconds	22	22	32	32	39	39	38	38	
Peak Torque Duration ¹⁰	T_{3x}	seconds	9	9	11	11	13	13	12	12	
NeoMetric Rotor Inertia	J	lb-in-sec ²	1.3 E-4	1.3 E-4	2.0 E-4	2.0 E-4	2.6 E-4	2.6 E-4	3.3 E-4	3.3 E-4	
		kg-m ²	1.5 E-5	1.5 E-5	2.2 E-5	2.2 E-5	3.0 E-5	3.0 E-5	3.7 E-5	3.7 E-5	
J Series Rotor Inertia	J	lb-in-sec ²	1.1 E-3	1.1 E-3	1.2 E-3	1.2 E-3	1.3 E-3	1.3 E-3	N/A	N/A	
		kg-m ²	1.3 E-4	1.3 E-4	1.4 E-4	1.4 E-4	1.5 E-4	1.5 E-4	N/A	N/A	
Number of Poles	Np		4	4	4	4	4	4	4	4	
NeoMetric Weight	#	lbs	3.5	3.5	4.5	4.5	6.0	6.0	7.3	7.3	
		kg	1.6	1.6	2.1	2.1	2.7	2.7	3.3	3.3	
J Series Weight	#	lbs	4.4	4.4	5.4	5.4	6.9	6.9	N/A	N/A	
		kg	2.0	2.0	2.5	2.5	3.1	3.1	N/A	N/A	
Winding Class			H	H	H	H	H	H	H	H	

* NeoMetric and J Series Specifications are identical unless otherwise noted.

- | | |
|---|---|
| <p>1 @ 25°C ambient, 150°C winding temperature, motor connected to a 10"x10"x1/4" aluminum mounting plate.
@40°C ambient derate phase currents and torques by 12%.</p> <p>2 Maximum speed is 7500 RPM. For higher speed operation please call the factory.</p> <p>3 Measured Line to Line, +/- 10%.</p> <p>4 Value is measured peak of sine wave.</p> <p>5 +/-30%, Line-to-Line, inductance bridge measurement @1Khz.</p> <p>6 Initial winding temperature must be 60°C or less before peak current is Applied.</p> | <p>7 Peak of the sinusoidal current in any phase for a sinusoidally commutated motor.</p> <p>8 Total motor torque per peak of the sinusoidal amps measured in any phase, +/-10%.</p> <p>9 Maximum time duration with 2 times rated current applied with initial winding temp at 60°C.</p> <p>10 Maximum time duration with 3 times rated current applied with initial winding temp at 60°C.</p> |
|---|---|

Note: These specifications are based on theoretical motor performance and are not specific to any amplifier.

Custom Designed Servo Motors For Your Specific Application. Call 1-800-358-9070 Today.

70 mm or Size 34, Encoder Feedback, Performance Curves (Neometric & J Series data are identical unless otherwise noted)

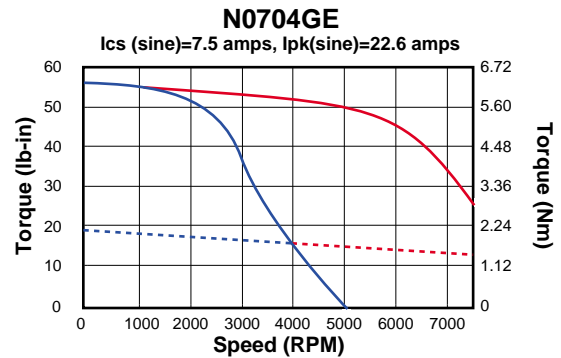
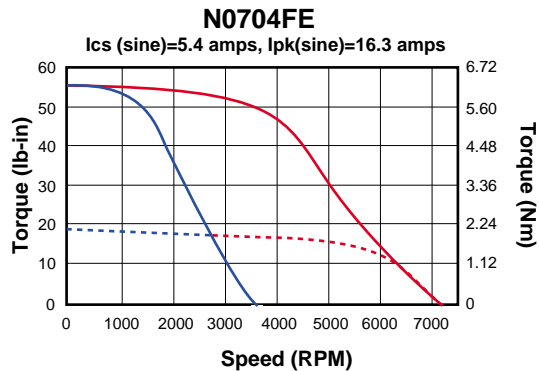
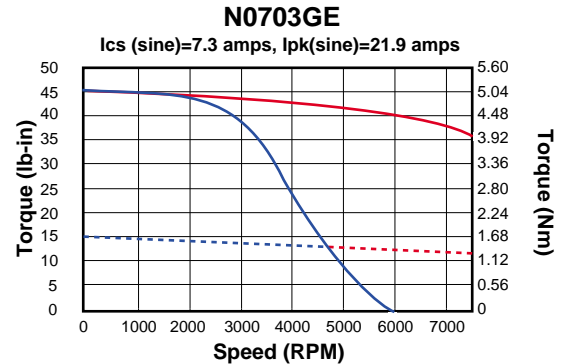
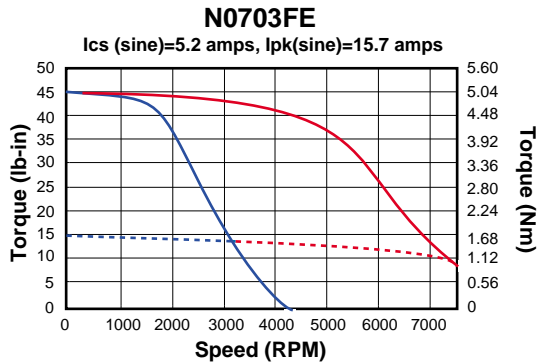
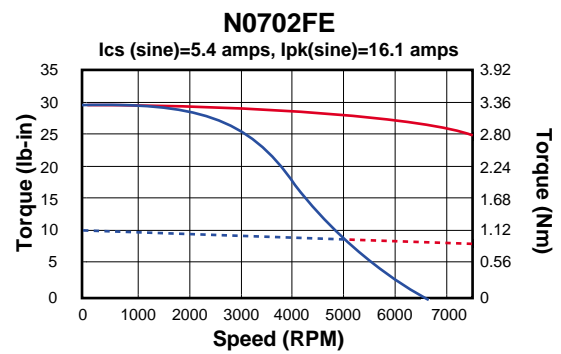
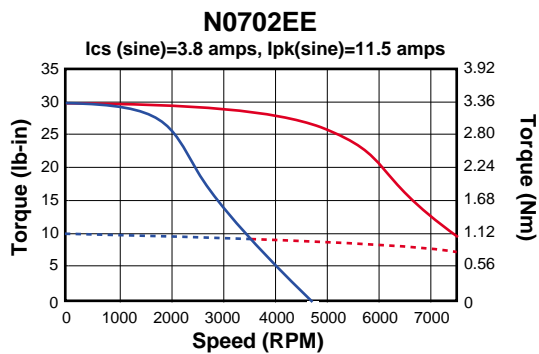
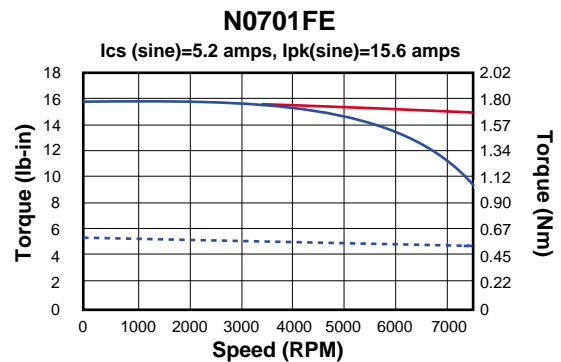
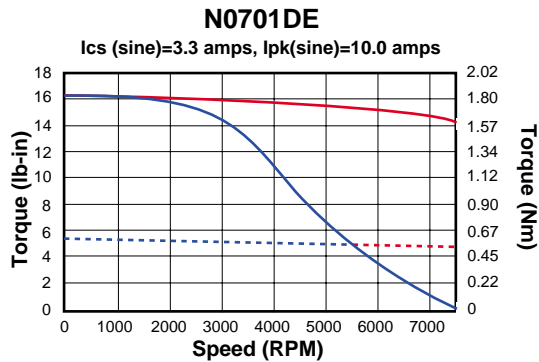

---- CONTINUOUS — PEAK ---- CONTINUOUS — PEAK
 170 VDC 340 VDC

92 mm, Encoder Feedback, Specifications*

Parameter	Symbol	Units	N0921F	N0921G	N0922G	N0922J	N0923H	N0923K	N0924J	N0924K
Stall Torque Continuous ¹	T_{cs}	lb-in	15.5	15.6	27.6	28.3	41.3	40.6	54.6	54.8
		oz-in	249	249	442	453	660	650	873	876
		Nm	1.74	1.74	3.09	3.17	4.62	4.55	6.11	6.14
Stall Current Continuous ^{1,4,8}	$I_{cs}(\text{sine})$	Amps Peak	4.7	6.6	6.5	10.1	10.0	17.4	10.8	15.2
Stall Current Continuous ^{1,7}	$I_{cs}(\text{trap})$	Amps DC	4.1	5.7	5.6	8.7	8.6	15.1	9.4	13.2
Peak Torque ⁶	T_{pk}	lb-in	46.6	46.7	82.9	83.5	123.7	121.9	163.8	164.3
		oz-in	746	747	1327	1336	1979	1951	2620	2629
		Nm	5.22	5.23	9.29	9.35	13.85	13.66	18.34	18.41
Peak Current ^{4,6,8}	$I_{pk}(\text{sine})$	Amps Peak	14.2	19.7	19.5	30.3	29.9	52.2	32.5	45.6
Peak Current ^{6,7}	$I_{pk}(\text{trap})$	Amps DC	12.3	17.1	26.9	26.2	25.9	45.2	28.2	39.5
Rated Speed ²	ω_r	rpm	6000	7500	4650	7300	4700	7500	3750	5250
Current @ Rated Speed	$I_r(\text{sine})$	Amps	4.1	5.2	5.6	7.0	8.6	11.9	9.7	12.4
Current @ Rated Speed	$I_r(\text{trap})$	Amps	3.5	4.5	4.8	6.0	7.4	10.3	8.4	10.7
Torque @ Rated Speed	T_r	lb-in	11.8	11.3	20.4	16.3	30.4	28.8	41.0	39.1
		oz-in	188	181	326	260	487	461	656	626
		Nm	1.32	1.27	2.28	1.82	3.41	3.23	4.59	4.38
Shaft Power @ Rated Speed	P_o	watts	834	1004	1121	1404	1689	2557	1820	2431
Voltage Constant ^{3,4}	K_b	Volts/rad/s	0.427	0.309	0.556	0.360	0.540	0.305	0.657	0.470
Voltage Constant ^{3,4}	K_e	Volts/KRPM	44.72	32.36	58.22	37.70	56.55	31.94	68.80	49.22
Torque Constant ⁹	$K_t(\text{sine})$	oz-in/Amp Peak	52.36	37.89	68.18	44.15	66.22	37.40	80.57	57.64
		Nm/Amp Peak	0.367	0.265	0.477	0.309	0.464	0.262	0.564	0.403
		oz-in/Amp DC	60.46	43.75	78.73	50.98	76.46	43.19	93.03	66.55
Torque Constant ^{3,4}	$K_t(\text{trap})$	Nm/Amp DC	0.423	0.306	0.551	0.357	0.535	0.302	0.651	0.466
Resistance ³	R	Ohms	3.72	1.94	2.32	0.96	1.28	0.42	1.22	0.62
Inductance ⁵	L	mH	17.11	8.99	14.72	6.18	14.95	4.78	20.60	10.51
Maximum Bus Voltage	V_m	Volts DC	340	340	340	340	340	340	340	340
Thermal Res Wind-Amb	$R_{th,w-a}$	°C/watt	1.06	1.06	0.91	0.91	0.7	0.7	0.62	0.62
Motor Constant	K_m	oz-in/ $\sqrt{\text{watt}}$	31.35	31.41	51.69	52.03	67.59	66.64	84.23	84.52
		Nm/ $\sqrt{\text{watt}}$	0.219	0.220	0.362	0.364	0.473	0.466	0.590	0.592
Viscous Damping	B	oz-in/Krpm	0.5	0.5	0.8	0.8	1.1	1.1	1.4	1.4
		Nm/krpm	3.5 E-3	3.5 E-3	5.6 E-3	5.6 E-3	7.7 E-3	7.7 E-3	9.8 E-3	9.8 E-3
Static Friction	T_f	oz-in	2.5	2.5	4.8	4.8	5.4	5.4	6.6	6.6
		Nm	1.8 E-2	1.8 E-2	3.4 E-2	3.4 E-2	3.8 E-2	3.8 E-2	4.6 E-2	4.6 E-2
Motor Thermal Time Constant	τ_{th}	minutes	21.6	21.6	30	30	35	35	37	37
Electrical Time Constant	τ_{elec}	milliseconds	4.60	4.63	6.34	6.44	11.68	11.38	16.89	16.95
NeoMetric Mech. Time Constant	τ_{mch}	milliseconds	0.8	0.8	0.5	0.5	0.4	0.5	0.4	0.4
J Series Mech. Time Constant	τ_{mch}	milliseconds	10.0	10.0	3.9	3.9	2.4	2.4	N/A	N/A
Intermittent Torque Duration ¹⁰	T_{2x}	seconds	48	48	39	39	61	61	61	61
Peak Torque Duration ¹¹	T_{3x}	seconds	17	17	13	13	16	16	15	15
NeoMetric Rotor Inertia	J	lb-in-sec ²	3.6 E-4	3.6 E-4	6.2 E-4	6.2 E-4	8.8 E-4	8.8 E-4	1.1 E-3	1.1 E-3
		kg-m ²	4.1 E-5	4.1 E-5	7.0 E-5	7.0 E-5	1.0 E-4	1.0 E-4	1.3 E-4	1.3 E-4
J Series Rotor Inertia	J	lb-in-sec ²	4.2 E-3	4.2 E-3	4.5 E-3	4.5 E-3	4.8 E-3	4.8 E-3	N/A	N/A
		kg-m ²	4.8 E-4	4.8 E-4	5.1 E-4	5.1 E-4	5.4 E-4	5.4 E-4	N/A	N/A
Number of Poles	Np		4	4	4	4	4	4	4	4
NeoMetric Weight	#	lbs	8.1	8.1	11.7	11.7	15.1	15.1	18.0	18.0
		kg	3.7	3.7	5.3	5.3	6.9	6.9	8.2	8.2
J Series Weight	#	lbs	9.9	9.9	13.5	13.5	16.9	16.9	N/A	N/A
		kg	4.5	4.5	6.1	6.1	7.7	7.7	N/A	N/A
Winding Class			H	H	H	H	H	H	H	H

* NeoMetric and J Series Specifications are identical unless otherwise noted.

- | | |
|---|--|
| <p>1 @ 25°C ambient, 125°C winding temperature, motor connected to a 10"x10"x1/4" aluminum mounting plate.</p> <p>2 Maximum speed is 7500 RPM.
For higher speed operation please call the factory.</p> <p>3 Measured Line to Line, +/- 10%.</p> <p>4 Value is measured peak of sine wave.</p> <p>5 +/-30%, Line-to-Line, inductance bridge measurement @1Khz.</p> <p>6 Initial winding temperature must be 60°C or less before peak current is Applied.</p> | <p>7 DC current through a pair of motor phases of a trapezoidally (six state) commutated motor.</p> <p>8 Peak of the sinusoidal current in any phase for a sinusoidally commutated motor.</p> <p>9 Total motor torque per peak of the sinusoidal amps measured in any phase, +/-10%.</p> <p>10 Maximum time duration with 2 times rated current applied with initial winding temp at 60°C.</p> <p>11 Maximum time duration with 3 times rated current applied with initial winding temp at 60°C.</p> |
|---|--|

Note: These specifications are based on theoretical motor performance and are not specific to any amplifier.

Custom Designed Servo Motors For Your Specific Application. Call 1-800-358-9070 Today.

92 mm, Resolver Feedback, Performance Curves

(Neometric & J Series data are identical unless otherwise noted)

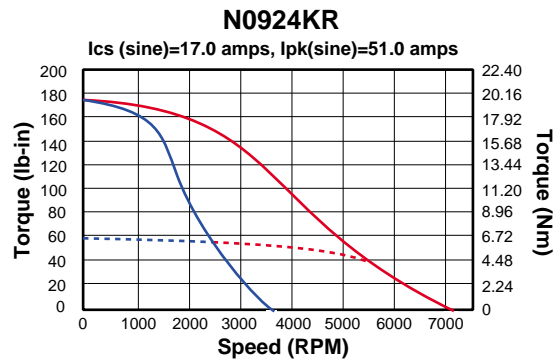
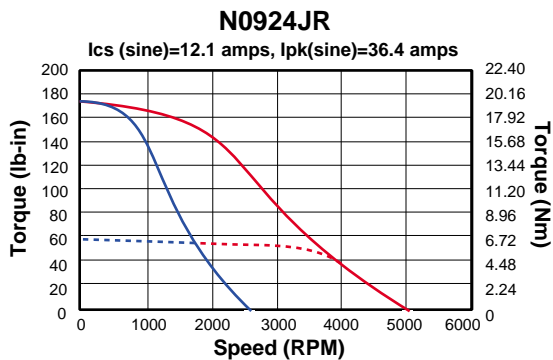
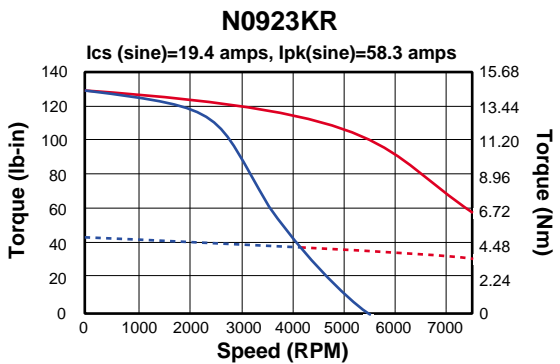
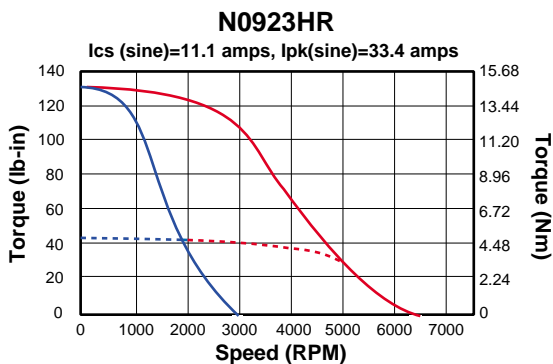
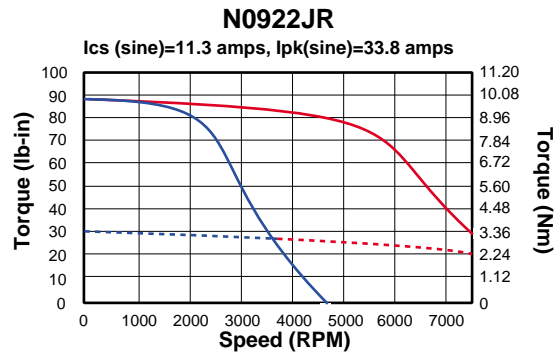
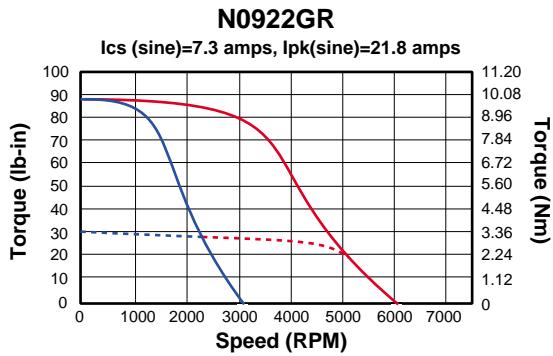
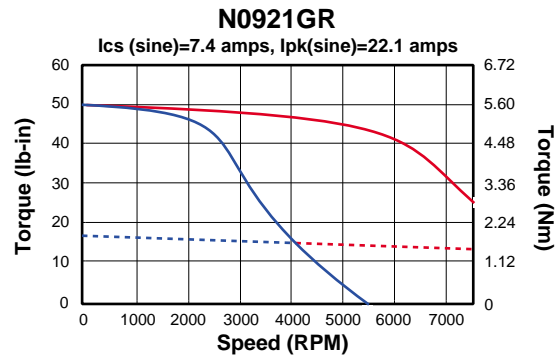
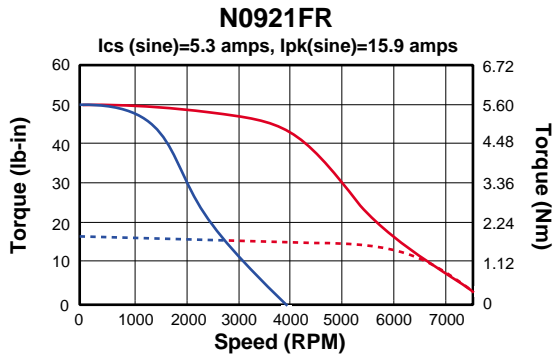

----- ——— ----- ———
 CONTINUOUS PEAK CONTINUOUS PEAK
 170 VDC 340 VDC

92 mm, Resolver Feedback, Specifications*

Parameter	Symbol	Units	N0921F	N0921G	N0922G	N0922J	N0923H	N0923K	N0924J	N0924K
Stall Torque Continuous ¹	T_{cs}	lb-in	17.4	17.4	30.9	31.1	46.1	45.4	61.1	61.3
		oz-in	278	279	495	498	737	727	977	980
		Nm	1.95	1.95	3.47	3.49	5.16	5.09	6.84	6.86
Stall Current Continuous ^{1,4,7}	$I_{cs}(\text{sine})$	Amps Peak	5.3	7.4	7.3	11.3	11.1	19.4	12.1	17.0
Peak Torque ⁶		T_{pk}	lb-in	52.1	52.3	92.8	93.4	138.3	136.3	183.1
Peak Current ^{4,6,7}	$I_{pk}(\text{sine})$	oz-in	834	836	1484	1494	2212	2181	2929	2940
		Nm	5.84	5.85	10.39	10.46	15.48	15.27	20.50	20.58
Rated Speed ²	ω_r	rpm	6000	7500	4700	7100	4500	7500	3600	5200
Current @ Rated Speed	$I_r(\text{sine})$	Amps	4.7	6.2	6.5	8.7	10.0	14.7	11.2	14.6
Torque @ Rated Speed	T_r	lb-in	12.7	12.9	25.9	23.3	34.1	30.1	46.3	42.7
		oz-in	203	207	414	372	545	481	740	683
		Nm	1.42	1.45	2.90	2.60	3.82	3.37	5.18	4.78
Shaft Power @ Rated Speed	P_o	watts	901	1148	1378	1954	1814	2668	1970	2627
Voltage Constant ^{3,4}	K_b	Volts/rad/s	0.427	0.309	0.556	0.360	0.540	0.305	0.657	0.470
Voltage Constant ^{3,4}	K_e	Volts/KRPM	44.72	32.36	58.22	37.70	56.55	31.94	68.80	49.22
Torque Constant ⁸	$K_t(\text{sine})$	oz-in/Amp Peak	52.36	37.89	68.18	44.15	66.22	37.40	80.57	57.64
		Nm/Amp Peak	0.367	0.265	0.477	0.309	0.464	0.262	0.564	0.403
Resistance ³	R	Ohms	3.72	1.94	2.32	0.96	1.28	0.42	1.22	0.62
Inductance ⁵	L	mH	17.11	8.99	14.72	6.18	14.95	4.78	20.60	10.51
Maximum Bus Voltage	V_m	Volts DC	340	340	340	340	340	340	340	340
Thermal Res Wind-Amb	$R_{th,w-a}$	°C/watt	1.06	1.06	0.91	0.91	0.7	0.7	0.62	0.62
Motor Constant	K_m	oz-in/ $\sqrt{\text{watt}}$	31.35	31.41	51.69	52.03	67.59	66.64	84.23	84.52
		Nm/ $\sqrt{\text{watt}}$	0.219	0.220	0.362	0.364	0.473	0.466	0.590	0.592
Viscous Damping	B	oz-in/Krpm	0.5	0.5	0.8	0.8	1.1	1.1	1.4	1.4
		Nm/krpm	3.5 E-3	3.5 E-3	5.6 E-3	5.6 E-3	7.7 E-3	7.7 E-3	9.8 E-3	9.8 E-3
Static Friction	T_f	oz-in	2.5	2.5	4.8	4.8	5.4	5.4	6.6	6.6
		Nm	1.8 E-2	1.8 E-2	3.4 E-2	3.4 E-2	3.8 E-2	3.8 E-2	4.6 E-2	4.6 E-2
Motor Thermal Time Constant	τ_{th}	minutes	21.6	21.6	30	30	35	35	36.6	36.6
Electrical Time Constant	τ_{elec}	microsecs	4.60	4.63	6.34	6.44	11.68	11.38	16.89	16.95
NeoMetric Mech. Time Const.	τ_{mch}	microsecs	1.2	1.2	0.7	0.7	0.5	0.5	0.4	0.4
J Series Mech. Time Constant	τ_{mch}	microsecs	10.0	10.0	3.9	3.9	2.4	2.4	N/A	N/A
Intermittent Torque Duration ⁹	T_{2x}	seconds	48	48	39	39	61	61	61	61
Peak Torque Duration ¹⁰	T_{3x}	seconds	17	17	13	13	16	16	15	15
NeoMetric Rotor Inertia	J	lb-in-sec ²	5.3 E-4	5.3 E-4	7.9 E-4	7.9 E-4	1.1 E-3	1.1 E-3	1.3 E-3	1.3 E-3
		kg-m ²	6.0 E-5	6.0 E-5	9.0 E-5	0.90 E-5	1.2 E-4	1.2 E-4	1.5 E-4	1.5 E-4
J Series Rotor Inertia	J	lb-in-sec ²	4.4 E-3	4.4 E-3	4.7 E-3	4.7 E-3	5.0 E-3	5.0 E-3	N/A	N/A
		kg-m ²	4.9 E-4	4.9 E-4	5.3 E-4	5.3 E-4	5.7 E-4	5.7 E-4	N/A	N/A
Number of Poles	Np		4	4	4	4	4	4	4	4
NeoMetric Weight	#	lbs	8.1	8.1	11.7	11.7	15.1	15.1	18.0	18.0
		kg	3.7	3.7	5.3	5.3	6.9	6.9	8.2	8.2
J Series Weight	#	lbs	9.9	9.9	13.5	13.5	16.9	16.9	N/A	N/A
		kg	4.5	4.5	6.1	6.1	7.7	7.7	N/A	N/A
Winding Class			H	H	H	H	H	H	H	H

* NeoMetric and J Series Specifications are identical unless otherwise noted.

- | | |
|--|---|
| <p>1 @ 25°C ambient, 150°C winding temperature, motor connected to a 10"x10"x1/4" aluminum mounting plate.</p> <p>2 @40C ambient derate phase currents and torques by 12%. Maximum speed is 7500 RPM. For higher speed operation please call the factory.</p> <p>3 Measured Line to Line, +/- 10%.</p> <p>4 Value is measured peak of sine wave.</p> <p>5 +/-30%, Line-to-Line, inductance bridge measurement @1Khz.</p> <p>6 Initial winding temperature must be 60°C or less before peak current is applied.</p> | <p>7 Peak of the sinusoidal current in any phase for a sinusoidally commutated motor.</p> <p>8 Total motor torque per peak of the sinusoidal amps measured in any phase, +/-10%.</p> <p>9 Maximum time duration with 2 times rated current applied with initial winding temp at 60°C.</p> <p>10 Maximum time duration with 3 times rated current applied with initial winding temp at 60°C.</p> |
|--|---|

Note: These specifications are based on theoretical motor performance and are not specific to any amplifier.

Custom Designed Servo Motors For Your Specific Application. Call 1-800-358-9070 Today.

92 mm, Resolver Feedback, Performance Curves

(Neometric & J Series data are identical unless otherwise noted)

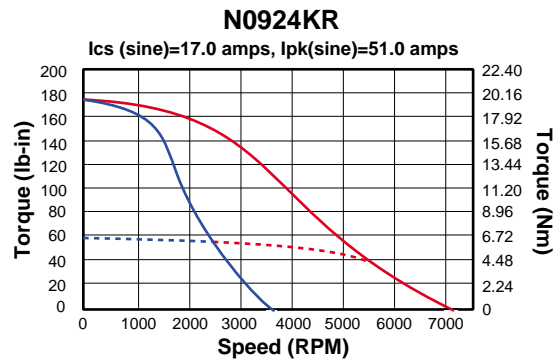
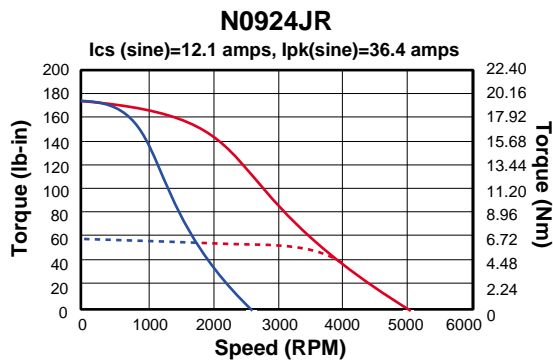
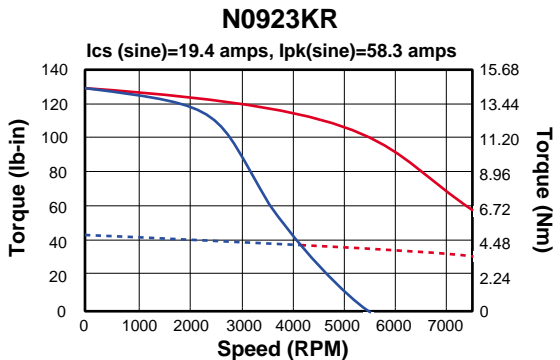
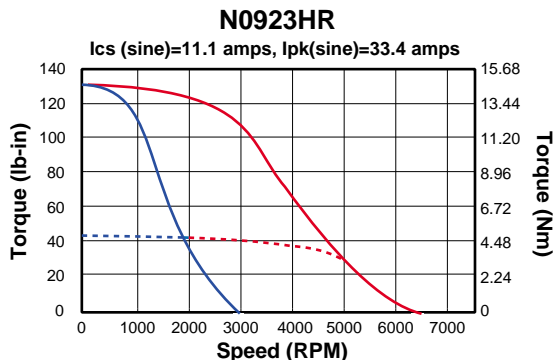
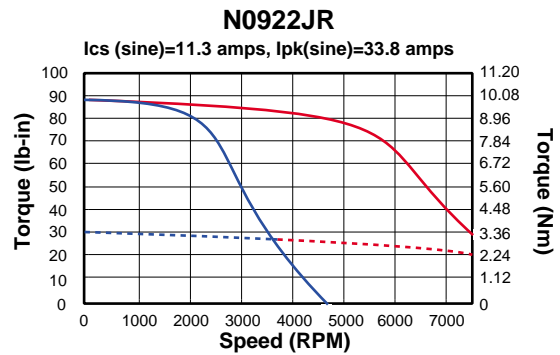
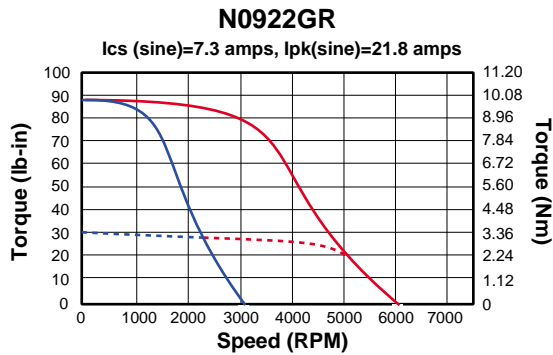
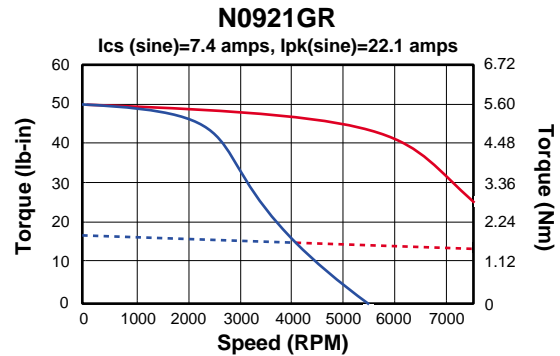
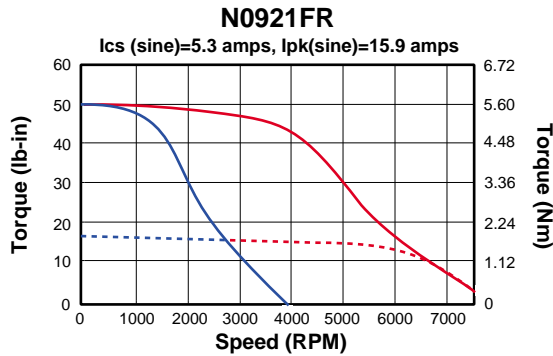

----- CONTINUOUS ——— PEAK
 170 VDC 340 VDC

NeoMetric & J Series Dimensional Drawings

70 mm Dimensional Drawing

Dimensions in mm (inches)

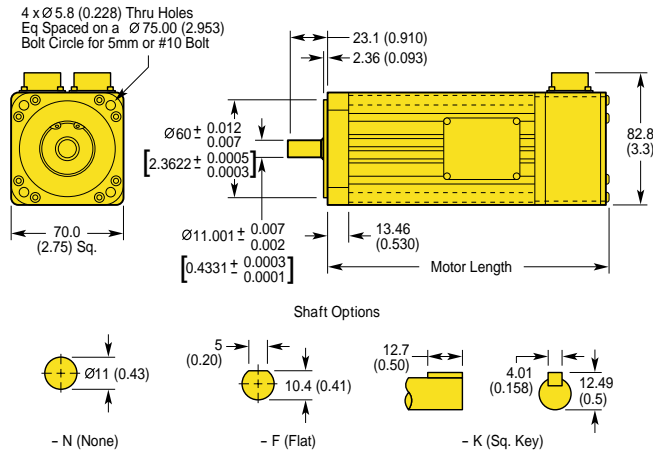

Motor Sizes

Model	Motor Length
N0701	125.5 (4.94)
N0702 J0701	150.9 (5.94)
N0703 J0702	176.3 (6.94)
N0704 J0703	201.7 (7.94)
N0701 w/ Brake	177.8 (7.00)
N0702 w/ Brake J0701 w/ Brake	203.2 (8.00)
N0703 w/ Brake J0702 w/ Brake	228.6 (9.00)
N0704 w/ Brake J0703 w/ Brake	254.0 (10.00)

Size 34, Dimensional Drawing

Dimensions in inches (mm)

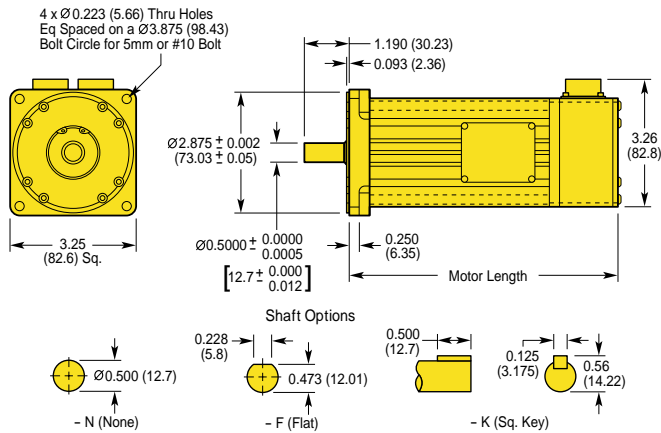

Motor Sizes

Model	Motor Length
N0341	4.94 (125.5)
N0342 J0341	5.94 (150.9)
N0343 J0342	6.94 (176.3)
N0344 J0343	7.94 (201.7)
N0341 w/ Brake	7.00 (177.8)
N0342 w/ Brake J0341 w/ Brake	8.00 (203.2)
N0343 w/ Brake J0342 w/ Brake	9.00 (228.6)
N0344 w/ Brake J0343 w/ Brake	10.00 (254.0)

92 mm Dimensional Drawing

Dimensions in mm (inches)

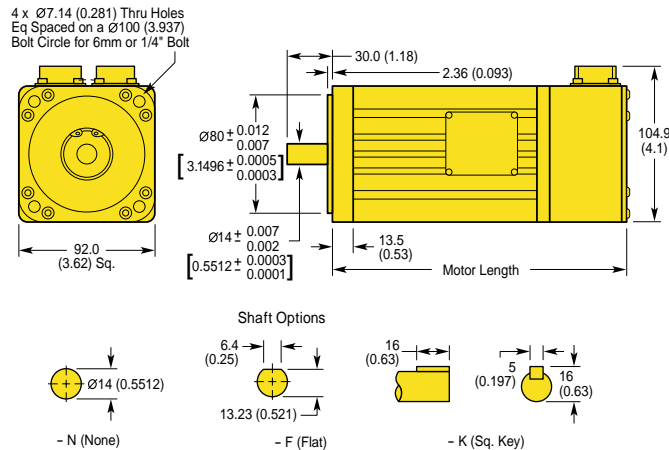

Motor Sizes

Model	Motor Length
N0921	168.4 (6.63)
N0922 J0921	206.5 (8.13)
N0923 J0922	244.6 (9.63)
N0924 J0923	282.7 (11.13)
N0921 w/ Brake	228.6 (9.00)
N0922 w/ Brake J0921 w/ Brake	266.7 (10.50)
N0923 w/ Brake J0922 w/ Brake	304.8 (12.00)
N0924 w/ Brake J0923 w/ Brake	342.9 (13.50)

Custom Designed Servo Motors For Your Specific Application. Call 1-800-358-9070 Today.

NeoMetric and J Series, Feedback Specifications

Resolver Schematic Diagram

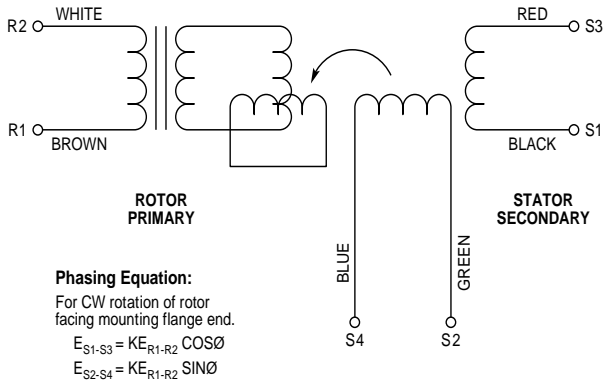

Encoder Specifications

Mechanical

Accuracy	±2 min of arc
Input power	5 VDC ±5%, 135 mA
Operating frequency	100 kHz max
Output device	26LS31
Sink/Source, nominal	20 mA
Suggested user interface	26LS32

Electrical

Resolver Specifications

Parameter	Value
Input voltage @ 7 kHz	4.25 volts
Input current, max	55 mA
Input power, nominal	0.12 watts
Impedance ZSO (@ 90°)	58+j145 ohms
Impedance ZRO	53+j72 ohms
Impedance ZRS	42+j55 ohms
Transformation ratio	0.470 ±5%
Output voltage	2.0 ±5% volts
DC rotor resistance	23 ±10% ohms
DC stator resistance	19 ±10% ohms
Sensitivity	35 mV/degree
Max error from EZ	±10 minutes
Phase shift, open circuit	5° leading, ±3" of arc
Null voltage, total	20 mV rms
Impedance ZSS	50+j128 ohms
Inertia	Incl. with motor spec.

Commutation Chart

Clockwise rotation as viewed from front shaft.

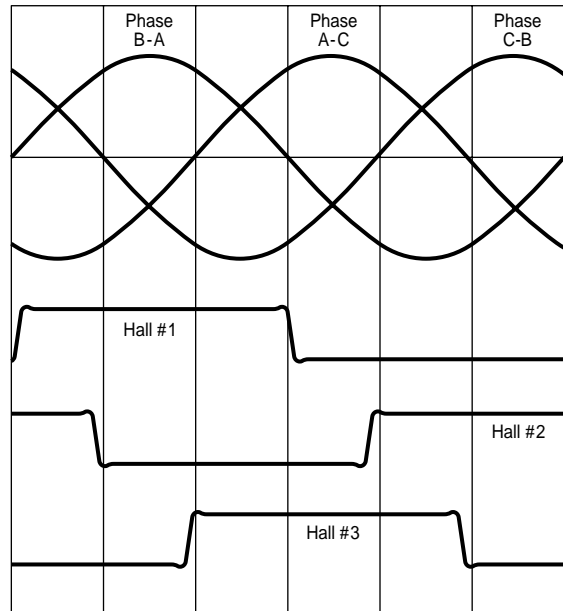

Hall-Effect Specifications

Electrical

Input power	5 VDC ±5%, 80 mA
Output device	LM339
open collector	
Maximum pull up	12 VDC
Sink	16 mA

Electrically Released Brakes

Brakes	70 mm or 34 Frame	92 mm
Static rated torque	24 in-lb	72 in-lb
Coil voltage	24 VDC	24 VDC
Coil current	0.8 amps	0.52 amps
Weight	1.0 lbs	2.51 lbs
Inertia	0.000038 lb-in-sec ²	0.00015 lb-in-sec ²
Engage/Disengage	100/200 ms	100/250 ms

Wiring and Cable Specifications

Flying Leads, Cabled and "MS" Connection Options

The **"FL" (Flying Lead) Connection** option for the NeoMetric and J Series motors features 18" leads extending from the motor body. Wire color codes are the same as listed below for "MS" wired NeoMetric and J Series motors. The "FL" option is only available on 70 mm/size 34 motors with encoder feedback.

The **"10" connection** option for the NeoMetric and J Series motors consists of 10 feet of hard-wired cable extending from the motor body. These cables terminate in flying leads. Wire color codes are the same as listed below for the "MS" connection option. The "10" option is only available on 70 mm/size 34 motors with encoder feedback.

The **"MS" connection** option for the NeoMetric and J Series motors provides quick disconnect, bayonet style connectors attached to the motor body. Mating cables are specified and ordered separately. With the "MS" connection option, the motor phase wires are in one connector, and the hall, encoder and temperature switch wires are in the other connector. This option works well when using an amplifier with a built-in controller, or when all cables enter into a cabinet or enclosure and then are wired into a terminal strip. When specifying the "R" (resolver) feedback option, the motor phase wires reside in one connector, the resolver signal and temperature switch wires in the other.

Encoder/Hall Feedback Connection

Designation	Pin Number MS14-18	Wire Color
Encoder +5	H	Red
Encoder Ground	G	Black
CH A +	A	White
CH A -	B	Yellow
CH B +	C	Green
CH B -	D	Blue
Index +	E	Orange
Index -	F	Brown
Hall Ground	K	White/Green
Hall +5	M	White/Blue
Hall 1	T	White/Brown
Hall 2	U	White/Orange
Hall 3	P	White/Violet
Brake ²	R	Red/Blue
Brake ²	S	Red/Blue
Temp	L	Orange/Yellow
Temp	N	Orange/Yellow
Shield	N.C.	Clear

Motor Connection

Designation	Pin Number MS14-12	Wire Color MS/RS Cables	Wire Color GS/GB Cables
Phase A	J	Red/Yellow	Black 1
Phase B	K	White/Yellow	Black 2
Phase C	L	Black/Yellow	Black 3
Ground	M	Green/Yellow	Green/Yellow
Shield	N.C.	Clear	N.C.

¹ 70 mm/size 34 motor connector is MS14-12. 92 mm motor connector is MS18-5.

² Brake will operate regardless of polarity of connection.

Resolver Feedback Connection

Designation	Pin Number MS14-12	Wire Color
S1, COS +	E	Black
S2, SIN +	L	Green
S3, COS -	J	Red
S4, SIN -	G	Blue
R1, EXC +	C	Brown
R2, EXC -	U	White
Temp	R	Orange/Yellow or Yellow
Temp	N	Orange/Yellow or Yellow
Brake ²	S	Red/Blue
Brake ²	T	Red/Blue
Shield	N.C.	Clear

Custom Designed Servo Motors For Your Specific Application. Call 1-800-358-9070 Today.

Wiring and Cable Specifications (continued)

“TQ” Connection Option (70mm/Size 34 Only)

The **“TQ” Connection** option for the NeoMetric or J series motors provides quick disconnect, bayonet style connectors attached to the motor body. Mating cables are specified and ordered separately. The “TQ” connection option joins the motor phase wires, temperature switch, and hall effect signals in one

connector. The second connector has only encoder signals. This connection option applies well in applications where the hall and motor phase wires connect directly to an amplifier, while the encoder signals connect directly to a controller.

Motor/Hall Connection

Designation	Pin Number MS14-12	Wire Color
Phase A	J	Red/Yellow
Phase B	K	White/Yellow
Phase C	L	Black/Yellow
Ground	M	Green/Yellow
Temp	G	Orange/Yellow or Yellow
Temp	H	Orange/Yellow or Yellow
Shield	N.C.	Clear
Hall Ground	F	White/Green
Hall +5	B	White/Blue
Hall 1	C	White/Brown
Hall 2	D	White/Orange
Hall 3	E	White/Violet

Encoder Feedback Connection

Designation	Pin Number MS14-18	Wire Color
Encoder +5	H	Red
Encoder Ground	G	Black
CH A +	A	White
CH A -	B	Yellow
CH B +	C	Green
CH B -	D	Blue
Index +	E	Orange
Index -	F	Brown
Brake ¹	R	Red/Blue
Brake ¹	S	Red/Blue

¹ Brake will operate regardless of polarity of connection

“PT” Connection Option

The **“PT” connection** option features two 1/2 - 14 NPT threaded holes in the connector housing, and internal screw terminal connections for motor and feedback leads. This connection option is recommended when running cable conduit between the motor and an enclosure containing the amplifier and controller. The “PT” connection option is only available on 92mm motors.