



Complete, Intelligent Motion in a Compact Package

The iBE is an entire servo motion control system in a single package, combining a servo motor drive, controller and I/O, and packing it into the back of a high-quality brushless servo motor. Motors are currently offered in NEMA 23 and 34 frame sizes.

Features

Performance

- Single-axis package motor/drive/controller
- 37-330 oz-in continuous torque
- Brushless DC servo motor
- Operates in position, velocity or torque mode
- Dual-encoder capability
- Limit switch inputs
- 7 programmable inputs or outputs

Language

- Easy Windows® software interface - iWare
- EEPROM for 32K of user program storage
- Multiple modes including camming and step & direction
- Infinite ratio gearing
- Change parameters on the fly

Protection

- Software current limit
- Thermal protection

Physical

- Single 24-48 VDC voltage input
- Battery operation is possible

Connectivity

- RS232/RS485 port

Motor Part Numbering System

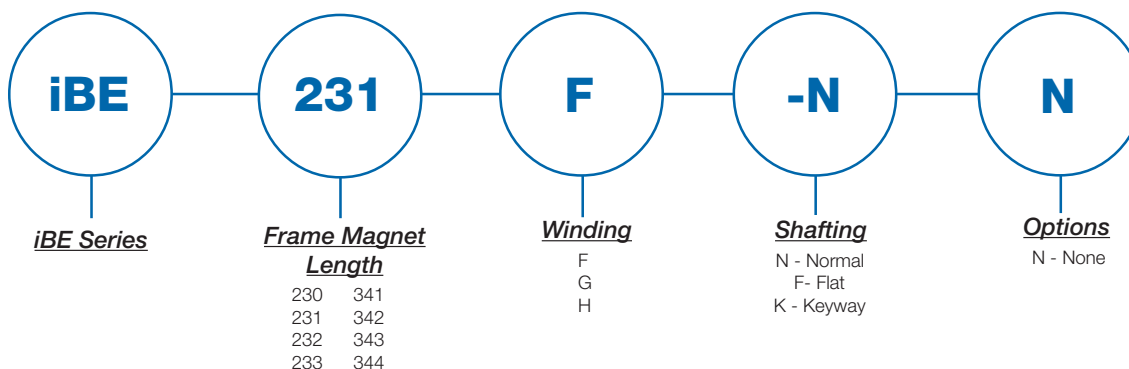

iBE Capabilities

- **Coordinated motion**

iBE motors can be daisy-chained over RS232 or linked via RS485 to coordinate motion and automate multi-axis machines. Position, velocity and acceleration can be precisely controlled to within 32 bits of resolution.

- **Torque and velocity control**

The iBE provides highly controllable, continuous torque, completely independent of position. Velocity, acceleration and deceleration can be modified on the fly.

- **Encoder following**

The iBE will follow an external encoder with virtually any gearing ratio. While the motor is performing electronic gearing, it can also run its internal program interpreter and communicate with peripherals. An external encoder can also be used to increment and decrement the internal 32-bit counter for later use within the application program.

- **Cam following**

Load a cam table for high-speed cam following with interpolation between table entries.

- **On-the-fly motion-parameter control**

All motion parameters are accessible before, during or after any move. Position, velocity, acceleration and tuning gains can all be changed continuously during motion. No stopping is necessary for perfect 32-bit profiling.

- **Intelligent communications**

The iBE's second RS485 port can be used to talk to intelligent peripherals like MFCs, light curtains, bar code readers, absolute encoders or even additional iBEs; in fact, the iBE can communicate with virtually any serially addressable device.

- **Stepper replacement**

Throughput on machines using traditional stepper or microstepper motors can be dramatically increased by replacing existing stepper axes with iBE motors.

- **Device connectivity**

The iBE has internal analog and digital I/O. For communications, the iBE offers RS232 and RS485 protocols.

- **Multi-node networking**

Multiple axes of iBE motors—up to 100—can be networked together without the usual hassle of encoder and drive cables. In addition, all home and limit sensors can be connected directly to the motors, reducing cabling to an unprecedented level of simplicity.

- **Configuration replication**

The iBE's unique all-digital, downloadable programming methodology means that each system's tuning and performance parameters can be exactly replicated. The user need never tune a servo again.

iBE Series, Size 23 Specifications

Parameter:	Symbol:	Units:	iBE230F	iBE231F	iBE232F	iBE233F
Stall Torque Continuous [1]	Tcs	oz-in	37.0	49.7	65.0	87.7
		lb-in	2.31	3.11	4.06	5.48
		Nm	0.26	0.35	0.46	0.62
Peak Torque [5]	Tpk	oz-in	148.0	198.8	260.1	350.6
		lb-in	9.25	12.43	16.26	21.91
		Nm	1.04	1.40	1.84	2.48
Max. Cont. Current from P.S.	Ics	amps (RMS)	2.73	2.58	2.18	2.58
Max. Peak Current from P.S.	Ipk	amps (RMS)	11.7	10.1	9.2	10.4
Maximum Bus Voltage [8]	Vm	volts DC	48	48	48	48
Rated Speed [2]	Wr	rpm	4950	4500	3300	2850
Torque@Rated Speed	Tr	oz-in	30.6	33.9	39.4	55.0
Shaft Power@Rated Speed	Po	watts	111.9	113.0	96.3	115.9
Voltage Constant [3, 4]	Kb	Volts/rad/s	0.07	0.0858	0.1102	0.1439
Voltage Constant [3, 4]	Ke	Volts/KRPM	7.3	9.0	11.5	15.1
Voltage Constant [3]	Kerms	Volts RMS/KRPM	5.2	6.4	8.2	10.7
Torque Constant [3,6]	Kt(sine)	oz-in/Amps Peak	8.6	10.5	13.5	17.6
Torque Constant [3, 4]	Kt(trap)	oz-in/Amps DC	9.9	12.1	15.6	20.4
Torque Constant [3]	Kt(RMS)	oz-in/Amps RMS	12.1	14.9	19.1	25.0
Thermal Res Internal-Amb	Rth w-a	C/watt	2.3	2.3	2.3	2.1
Thermal Res Internal-Case	Rth w-c	C/watt	1.28	0.88	0.56	0.49
Thermal Res Case-Amb	Rth c-a	C/watt	1.02	1.42	1.74	1.61
Motor Constant	Km	oz-in/sqrt(watt)	8.8	14.6	22.3	28.5
Viscous Damping	B	oz-in/Krpm	0.25	0.35	0.5	0.7
Static Friction	Tf	oz-in	0.75	1.25	2	2.5
Motor Thermal Time Constant	Tau_th	seconds	696	798	900	1200
Winding Thermal Time Const	Tau_wnd	seconds	96	96	90	90
Mechanical Time Constant	Tau_mch	milliseconds	1.36	0.85	0.68	0.58
Intermittent Torq Duration [7]	T_2x	seconds	10	13	13	13
Peak Torque Duration [7]	T_3x	seconds	4	9	13	13
Rotor Inertia	J	lb-in-sec ²	0.000046	0.00008	0.00015	0.00021
Rated Winding Temperature	WTr	C	70	70	70	70
Rated Ambient Temperature	Tamb	C	25	25	25	25
Rated Case Temp	Tcase	C	45.0	52.8	59.0	59.5
Number of Poles	Np		8	8	8	8
Weight	#	lbs	1.54	2.1	3.08	4.05
Winding Class			H	H	H	H

- 1 @40°C ambient derate phase currents and torques by 7%.
- 2 For higher speed operation please call the factory.
- 3 Measured Line to Line, +/- 10%.
- 4 Value is measured peak of sine wave.
- 5 Initial winding temperature must be 60°C or less before Peak Current is applied.
- 6 Total motor torque per peak of the sinusoidal amps measured in any phase, +/-10%.
- 7 Maximum Time duration with 2 times (or 3 times) rated current applied with initial winding temp at 60°C.
- 8 48VDC nominal, 52VDC maximum (a 48VDC supply may run up to 10% high = 52VDC).

Size 23 Speed-Torque Curves

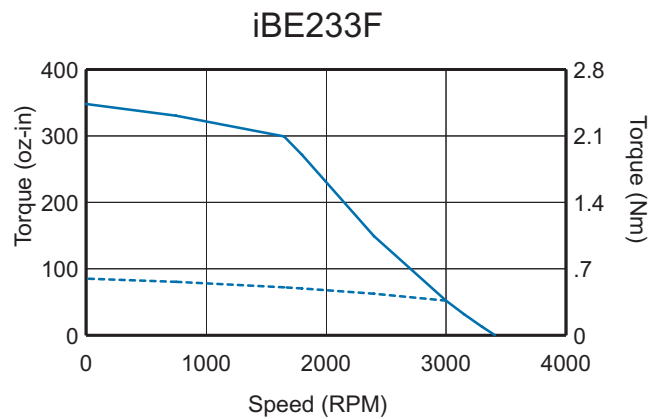
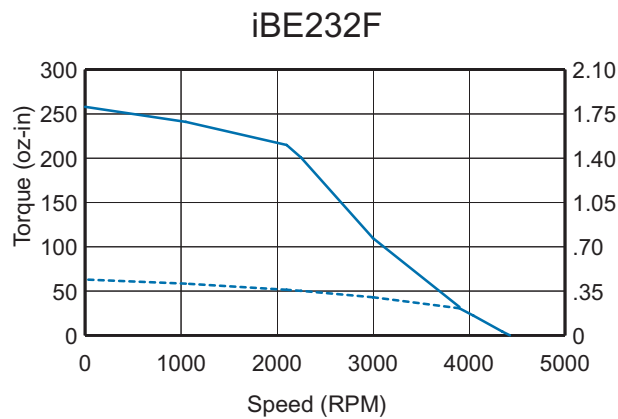
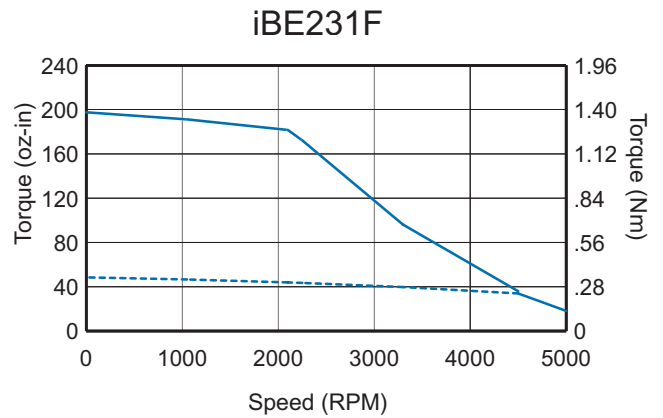
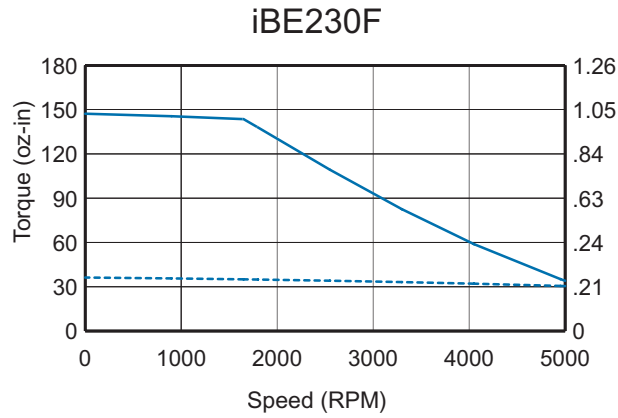

----- CONTINUOUS
————— PEAK
 (48VDC)

Performance tested with the iPS-500W power supply

iBE Series, Size 34 Specifications

Parameter:	Symbol:	Units:	iBE341G	iBE341H	iBE342G	iBE342H	iBE343G	iBE343H	iBE344G	iBE344H
Stall Torque Continuous [1]	Tcs	oz-in	134.7	108.1	201.3	155.6	258.7	193.2	330.0	251.1
		lb-in	8.42	6.76	12.58	9.73	16.17	12.08	20.63	15.69
		Nm	0.95	0.76	1.42	1.10	1.83	1.36	2.33	1.77
Peak Torque [5]	Tpk	oz-in	538.7	432.6	805.2	622.5	1034.8	767.5	1320.1	1004.3
		lb-in	33.67	27.04	50.33	38.91	64.68	47.97	82.51	62.77
		Nm	3.80	3.05	5.68	4.39	7.31	5.42	9.32	7.09
Max. Cont. Current from P.S.	Ics	amps (RMS)	3.6	4.2	4.1	4.9	4.4	5	4.6	5.5
Max. Peak Current from P.S.	Ipk	amps (RMS)	13.8	12.7	14.4	14.2	14.7	13.7	15.6	15.1
Maximum Bus Voltage [8]	Vm	volts DC	48	48	48	48	48	48	48	48
Rated Speed [2]	Wr	rpm	1690	2990	1430	2600	1170	2210	910	1690
Torque@Rated Speed	Tr	oz-in	122.7	85.1	170.9	118.6	230.8	143.0	301.9	203.8
Shaft Power@Rated Speed	Po	watts	153.4	188.2	180.7	228.1	199.8	233.7	203.2	254.8
Voltage Constant [3, 4]	Kb	Volts/rad/s	0.1871	0.0936	0.2648	0.1324	0.304	0.152	0.405	0.202
Voltage Constant [3, 4]	Ke	Volts/KRPM	19.6	9.8	27.7	13.9	31.8	15.9	42.4	21.2
Voltage Constant [3]	Kerms	Volts RMS/KRPM	13.9	6.9	19.6	9.8	22.5	11.3	30.0	15.0
Torque Constant [3,6]	Kt(sine)	oz-in/Amps Peak	22.9	11.5	32.5	16.2	37.3	18.6	49.7	24.8
Torque Constant [3, 4]	Kt(trap)	oz-in/Amps DC	26.5	13.3	37.5	18.7	43.0	21.5	57.3	28.6
Torque Constant [3]	Kt(RMS)	oz-in/Amps RMS	32.4	16.2	45.9	23.0	52.7	26.4	70.2	35.0
Thermal Res Internal-Amb	Rth w-a	C/watt	1.336	1.336	1.19	1.19	1.045	1.045	0.96	0.96
Thermal Res Internal-Case	Rth w-c	C/watt	0.52	0.52	0.33	0.33	0.19	0.19	0.17	0.17
Thermal Res Case-Amb	Rth c-a	C/watt	0.816	0.816	0.86	0.86	0.855	0.855	0.79	0.79
Motor Constant	Km	oz-in/sqrt(watt)	29.6	29.6	46.2	45.5	60.9	62.1	72.3	71.5
Viscous Damping	B	oz-in/Krpm	1.08	1.08	1.33	1.33	1.7	1.7	2	2
Static Friction	Tf	oz-in	1.7	1.7	2.7	2.7	4.2	4.2	5	5
Motor Thermal Time Constant	Tau_th	seconds	1296	1296	1500	1500	1998	1998	1998	1998
Winding Thermal Time Const	Tau_wnd	seconds	102	102	78	78	78	78	72	72
Mechanical Time Constant	Tau_mch	millisecs	0.75	0.75	0.47	0.48	0.37	0.36	0.35	0.35
Intermittent Torq Duration [7]	T_2x	seconds	13	13	13	13	13	13	13	13
Peak Torque Duration [7]	T_3x	seconds	10	13	13	13	13	13	13	13
Rotor Inertia	J	lb-in-sec ²	0.00029	0.00029	0.00044	0.00044	0.00061	0.00061	0.0008	0.0008
Rated Winding Temperature	WTr	C	70	70	70	70	70	70	70	70
Rated Ambient Temperature	Tamb	C	25	25	25	25	25	25	25	25
Rated Case Temp	Tcase	C	52.5	52.5	57.5	57.5	61.8	61.8	62.0	62.0
Number of Poles	Np		8	8	8	8	8	8	8	8
Weight	#	lbs	4.911	4.911	7.133	7.133	9.233	9.233	11.24	11.24
Winding Class			H	H	H	H	H	H	H	H

- 1 @40°C ambient derate phase currents and torques by 7%.
- 2 For higher speed operation please call the factory.
- 3 Measured Line to Line, +/- 10%.
- 4 Value is measured peak of sine wave.
- 5 Initial winding temperature must be 60°C or less before Peak Current is applied.
- 6 Total motor torque per peak of the sinusoidal amps measured in any phase, +/-10%.
- 7 Maximum Time duration with 2 times (or 3 times) rated current applied with initial winding temp at 60°C.
- 8 48VDC nominal, 52VDC maximum (a 48VDC supply may run up to 10% high = 52VDC).

Size 34 Speed-Torque Curves

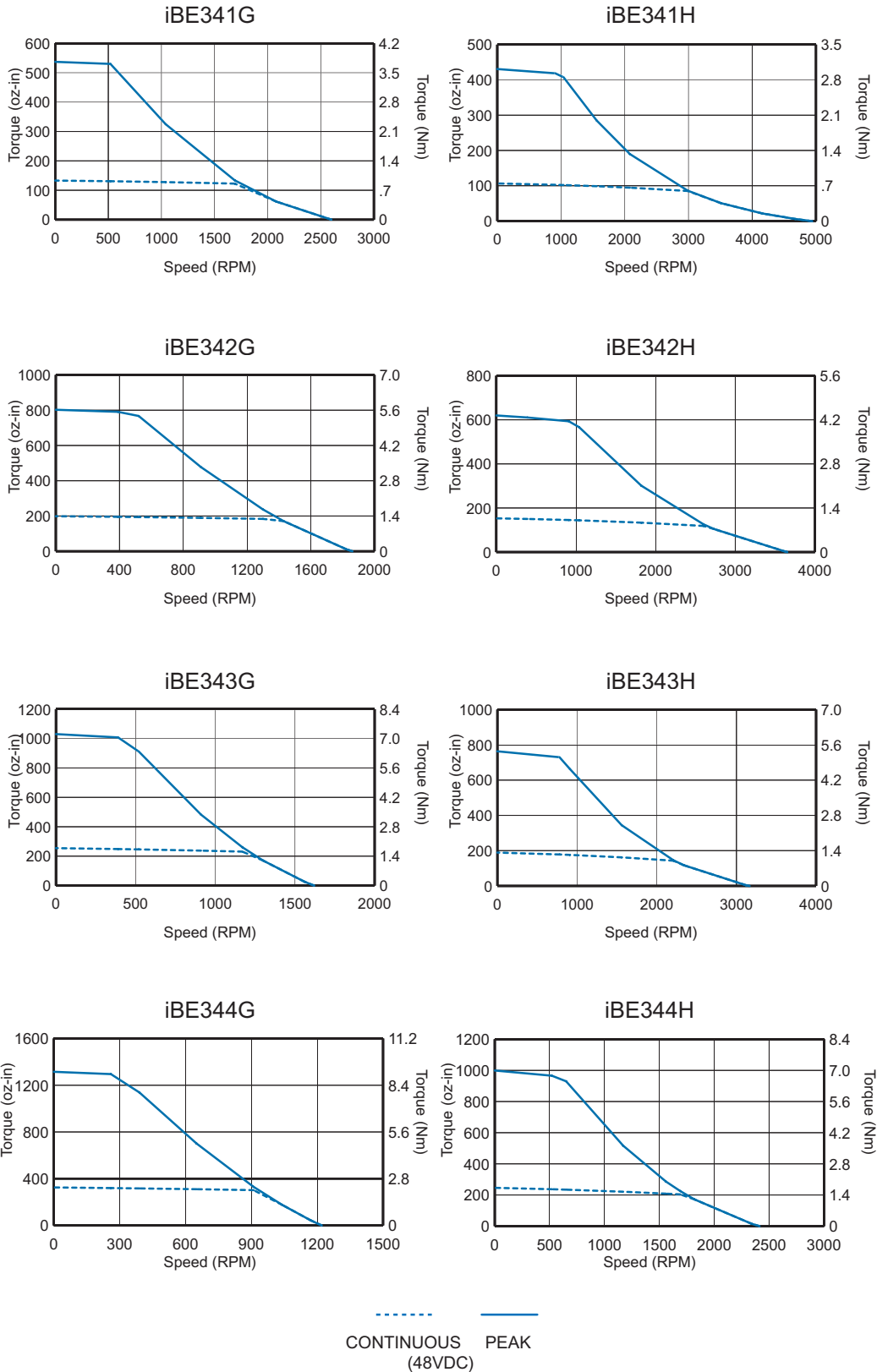

Performance tested with two iPS-500W power supplies connected in parallel

Connections

I/O

15-Pin D-sub I/O

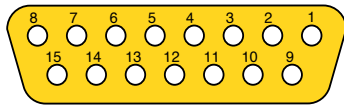

1	I/O A	9	Encoder B Out
2	I/O B	10	RS232 Transmit
3	I/O C/Limit	11	RS232 Receive
4	I/O D/Limit	12	+5V Out
5	I/O E/RS485	13	Ground
6	I/O F/RS485	14	Power Ground
7	I/O G	15	Power
8	Encoder A Out		

Power and I/O

7-Pin Combo D-sub

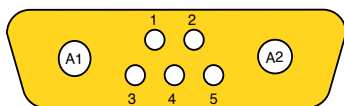

A1	+20V to +48V DC	3	RS232 Transmit
A2	Power Ground	4	RS232 Receive
1	Sync or I/O G	5	RS232 Ground
2	+5V Out		

Cables and Accessories

P/N	Description
VM15	15-Pin I/O connector breakout (includes 2' cable)
71-020710-XX	Power/communication cable, flying leads, -05 or -10 FT
71-020711-XX	15-pin I/O cable, male D-sub to flying leads, -05 or -10 FT
71-020911-15	15-pin I/O cable, 24VDC I/O, flying leads, 15 FT
iPS-500W	500W power supply, 48VDC 10A
iPS-1000W	1000W power supply, 48VDC 20A
iSHUNT	100W shunt, 56V trip, for use in vertical applications
iPS-500W-SHUNT	iPS-500W with 100W shunt
iCONN-KIT	iBE D-sub connector kit



The iBE Series servo motion system is offered in NEMA 23 and 34 frame sizes.

Dimensional Drawings

iBE23

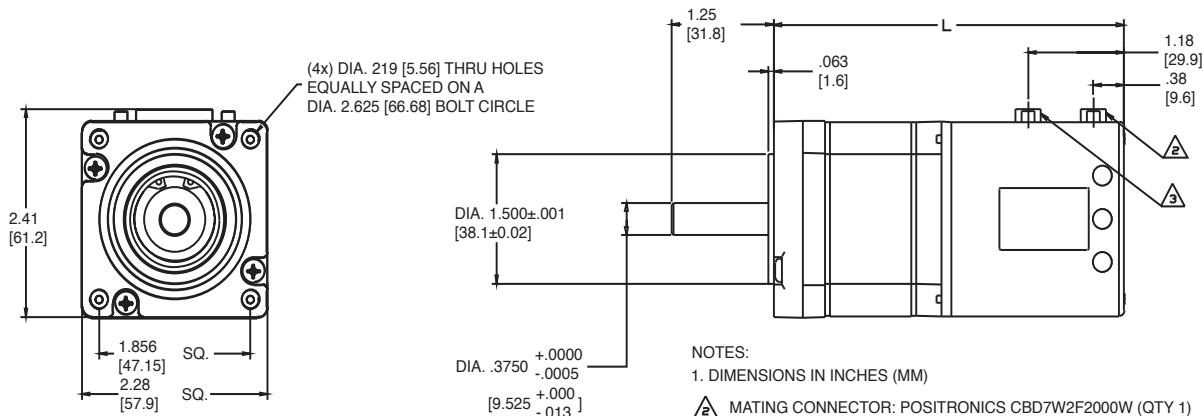

MODEL	MOTOR LENGTH "L"
IBE230	3.80 [96.5]
IBE231	4.30 [109.2]
IBE232	5.30 [134.6]
IBE233	6.30 [160.0]

- NOTES:
1. DIMENSIONS IN INCHES (MM)
- ⚠ MATING CONNECTOR: POSITRONICS CBD7W2F2000W (QTY 1)
MATING CONNECTOR SOCKET CONTACT: POSITRONICS FS4012D (QTY 2)
MATING CONNECTOR HOOD: POSITRONICS D15000Z000 (QTY 1)
 - ⚠ MATING CONNECTOR: AMP 205206-3 (QTY 1)
MATING CONNECTOR PIN CONTACT: AMP 1-66506-0 (QTY 15)
MATING CONNECTOR HOOD: POSITRONICS D15000Z000 (QTY 1)

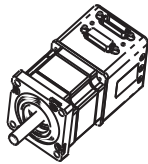

iBE34

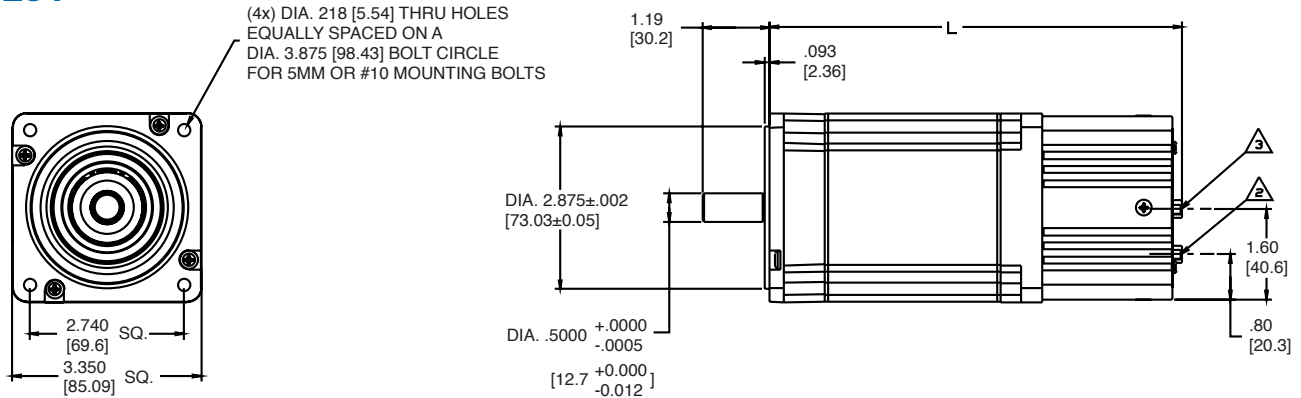

MODEL	MOTOR LENGTH "L"
IBE341	5.32 [135.1]
IBE342	6.32 [160.5]
IBE343	7.32 [185.9]
IBE344	8.32 [211.3]

- NOTES:
1. DIMENSIONS IN INCHES (MM)
- ⚠ MATING CONNECTOR: POSITRONICS CBD7W2F2000W (QTY 1)
MATING CONNECTOR SOCKET CONTACT: POSITRONICS FS4012D (QTY 2)
MATING CONNECTOR HOOD: POSITRONICS D15000Z000 (QTY 1)
 - ⚠ MATING CONNECTOR: AMP 205206-3 (QTY 1)
MATING CONNECTOR PIN CONTACT: AMP 1-66506-0 (QTY 15)
MATING CONNECTOR HOOD: POSITRONICS D15000Z000 (QTY 1)

