

ComTrac[®]

Adjustable Speed Drives



Speed Control Made Simple!



**STANDARD
3-DAY
DELIVERY**



"we don't say we're best...our customers do"

www.stober.com





ComTrac® Adjustable Speed Drives

Company Profile

STÖBER was first established in Germany in 1934, and has been a pioneer in the gearing industry ever since. Through constant innovation, STÖBER today is known for high precision, high efficiency and low noise in their various gearing technologies. STÖBER® Drives Inc., located in Maysville KY, manufactures products to serve the North American market.

Beginning with the ComTrac® Mechanical Variable Speed Reducers, STÖBER established itself as a technology leader, later adding the innovative MGS® Modular Gear System to the product offering. MGS® Food and Beverage Reducers excel in the harshest of washdown environments.

STÖBER next introduced ServoFit® Precision Planetary Gearheads, establishing the standard for low noise and low backlash in the servo industry. The recent introduction of the SMS® ServoFit Modular System gearheads adds a high precision, cost effective alternative to the servo market.

STÖBER has the broadest offering of speed reducers available, providing one stop shopping for both the industrial market and the rapidly growing motion control market.

On behalf of the worldwide family of STÖBER employees, we thank you for trying our products and pledge to continue to meet your product and service needs with the newest solutions.

Sincerely,

Bernd Stöber, Chairman
Stöber Antriebstechnik GmbH

Peter Feil, VP/General Manager
STÖBER Drives, Inc.



Table of Contents

ComTrac Adjustable Speed Drives

Advantages and Features	2
Performance	3
Washdown Duty	4
Operating Characteristics	5
Ratings and Dimension	
.50 HP	6
.75 HP	7
1.0 HP	8
1.5 HP	9
2.0 HP	10
3.0 HP	11
5.0 HP	12
7.50 HP	13
10.0 HP	14
Electric Remote Control (ERC)	15
Selection and Performance Characteristics	16
Installation Instructions	18
Maintenance and Lubrication	20

"C" Series MGS Adjustable Speed Drives

Performance Specifications	21
Ratings	22
Dimensions	40
Mounting Positions	78

"F" Series MGS Adjustable Speed Drives

Performance Specifications	43
Ratings	44
Dimension	50
Mounting Positions	78

"K" Series MGS Adjustable Speed Drives

Performance Specifications	53
Ratings	54
Dimensions	72
Mounting Positions	79
Mounting Hollow Output Units	76
Mounting Positions	77
Terms and Conditions	80



Advantages:

You're probably already aware of the many common-sense advantages offered by traction-type adjustable speed drives like the ComTrac drive. When compared to mechanical belt-type, or electrical adjustable speed drives, traction type drives offer:

- Often, a lower initial cost.
- Few worries about motor overheating during low speed operation.
- No motor brushes to replace.
- Very compact and lightweight when compared to other mechanical drives.
- Simple design with few rotating components to wear or replace.
- Easily serviced by semiskilled personnel
- Low maintenance — doesn't need to be cycled through its speed range to prevent component damage.
- 2 year warranty—your assurance of satisfactory product performance.

Features:

Drive cone — The drive cone is made from ductile iron and is precision ground for long service life. It contains inner air chambers for efficient heat dissipation. It is independently supported by a shielded bearing mounted into the motor adapter/slide — not just by the motor bearing.

Traction ring — ComTrac's self-lubrication traction ring is made from a proprietary material that provides exceptional resistance to wear and high temperatures. When replacement is necessary, only the ring and not the entire friction ring mounting flange is replaced.

Speed adjustment — ComTrac's rack and pinion speed adjustment system features stainless steel components to resist corrosion and is dust resistant by design. The stainless steel pinion shaft and ductile iron rack are designed to provide assured speed adjustments in the wettest, dirtiest environments.

Handwheel control — Handwheel control with a position indicator is standard on every ComTrac drive. Remote speed controls and overspeed protection is also available.

All ComTrac drives are shipped with the handwheel positioned on the left *as viewed from the output shaft end* of the drive. The handwheel can be quickly and easily moved to the right side by using the tools and instructions included with the drive.

Mounting position — ComTrac drives can be mounted in virtually any position.

NEMA C-face input — All ComTrac drives feature a NEMA C-face input — that means standard off-the-shelf motors, available locally. ComTrac's patented corrosion resistant collet clamp ring makes motor shaft attachment fast and simple. The proper hex wrenches are included with each unit in the motor access cover. When the motor must be replaced, it can be done easily and quickly without disassembly of the entire drive.

In addition, the 0F unit is standard with a NEMA C-face output flange. It enables you to add adjustable speed capability to new or existing applications.

Torque compensator — The torque compensator assembly features high-capacity cylindrical roller bearings — not needle bearings — for long life and quiet operation. The design allows speed changes during operation or while the drive is at rest. The load compensating cams precisely match the pressure between the drive cone and the traction ring in proportion to the load torque.

Cast iron housing — High tensile strength cast iron housing for long service life in demanding applications.

Stainless steel nameplate.

Two year warranty — Every ComTrac unit is backed by a two-year warranty.

Delivery — ComTrac units are shipped in 3 days or less.

Selection:

In general, proper selection of a ComTrac drive is as easy as the drive is to operate.

1. Establish the maximum horsepower required by the driven machine at maximum speed.
2. Select the drive which meets or exceeds the maximum HP rating of the driven machine at maximum speed.

Part No. Example:

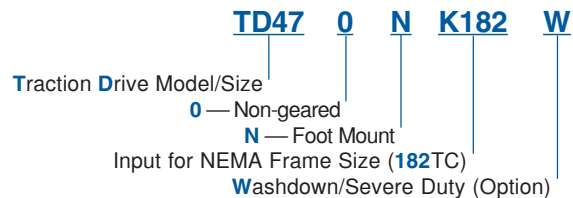
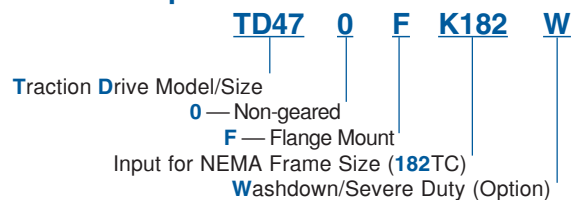

Speed Control Made Simple!



ComTrac® Adjustable Speed Drives

Performance Specifications:

- Horsepower ratings — from 1/2 to 10
- Output speeds — available from 2180 to 311 RPM
- Speed range — 5:1 to 7:1
- Output torques — up to 496 in.lbs.
- NEMA frames — from 56C to 215TC

**STANDARD
3-DAY
DELIVERY**

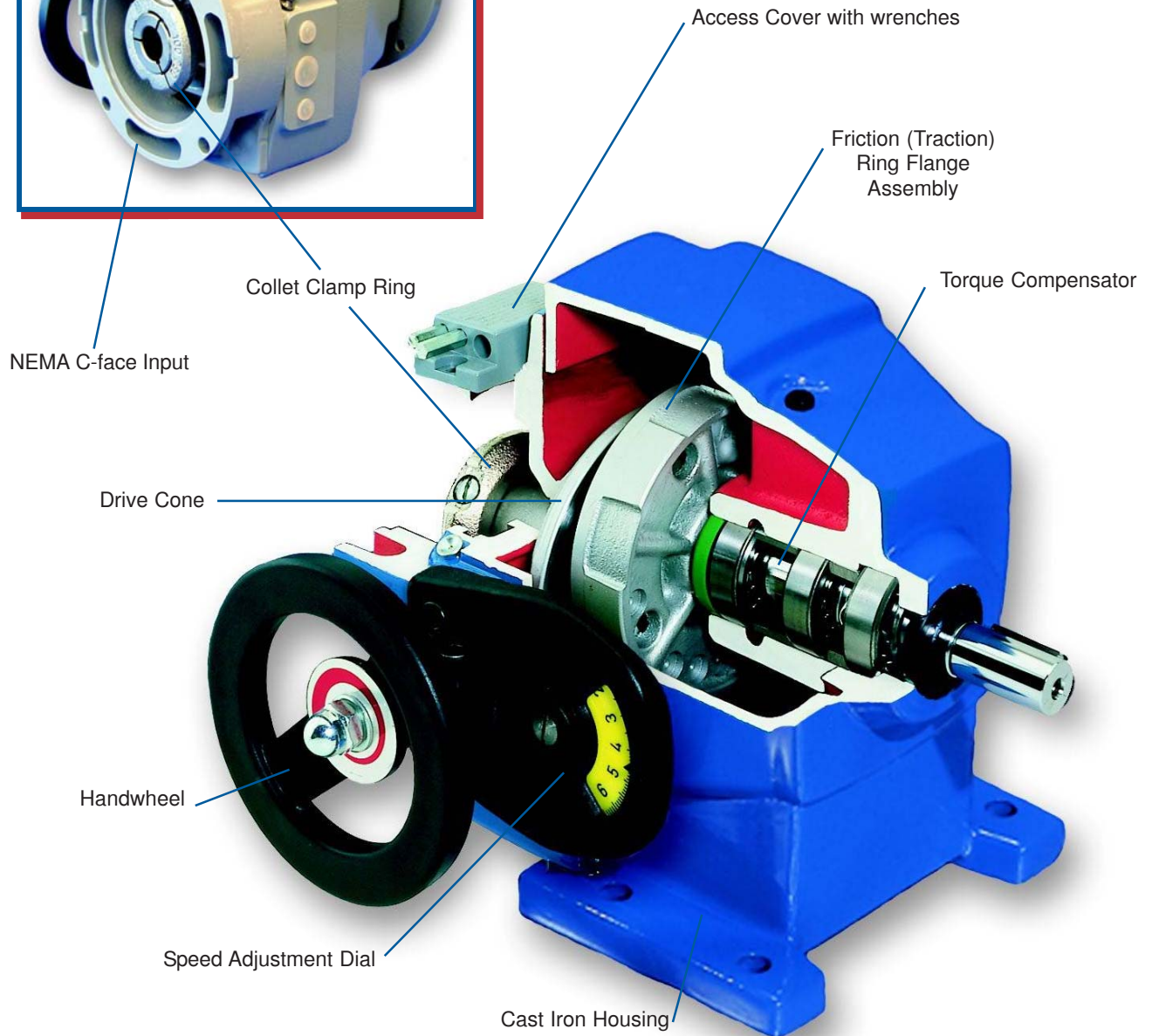
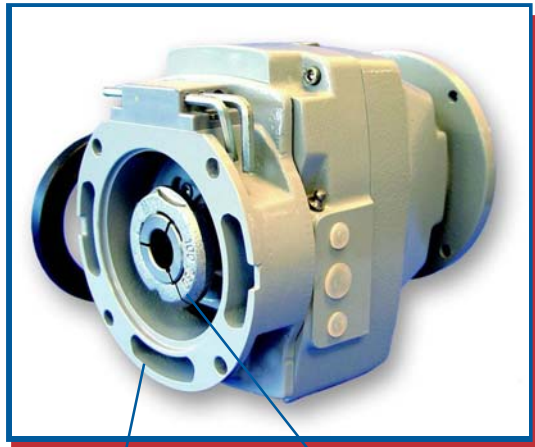

ComTrac® Adjustable Speed Drives Washdown/Outdoor Service/ Severe Duty



Advantages:

STÖBER has developed a severe duty protection package for ComTrac drives which significantly improves the drives' ability to withstand the effects of outdoor use, exposure to excessively humid or acidic environments, or spray washed with water or caustic fluids.

The ComTrac severe duty package includes corrosion protection for all functional components and housings including:

- Drive cone
- Motor clamping ring
- Motor slide and rack
- Bearing housing
- Main housing cover

To prevent corrosion, these components are protected by a special heat treatment process similar to chrome plating.

Features:

Drive cone — Corrosion protected drive cone extends cone and ring life.

Speed adjustment — The protected motor slide, stainless steel control shaft with pinion, and greased rack and slideway assure the proper speed adjustment.

NEMA C-face input — ComTrac's patented corrosion resistant collet clamp ring assures ease of motor replacement.

External surface — All external surfaces are protected with a special acid-resistant epoxy paint to prevent corrosion and lubricant contamination.

Internal surface — All internal surfaces and bearing housing are protected with a special anticorrosion paint.

Double seals — Double output seals can be provided for maximum protection in very harsh environments.

Mounting position — ComTrac drives in a vertical mounting position (output shaft down) must be adapted to allow water to drain.

Stainless steel nameplate — Other features of the severe duty unit are: stainless steel nameplate, rivets, and chrome plated bolts.

Two year warranty — Like the standard drive, this ComTrac unit is also backed by a two-year warranty.

Delivery — ComTrac units are shipped in 3 days or less.

STANDARD
3-DAY
DELIVERY





ComTrac® Adjustable Speed Drives Operating Characteristics

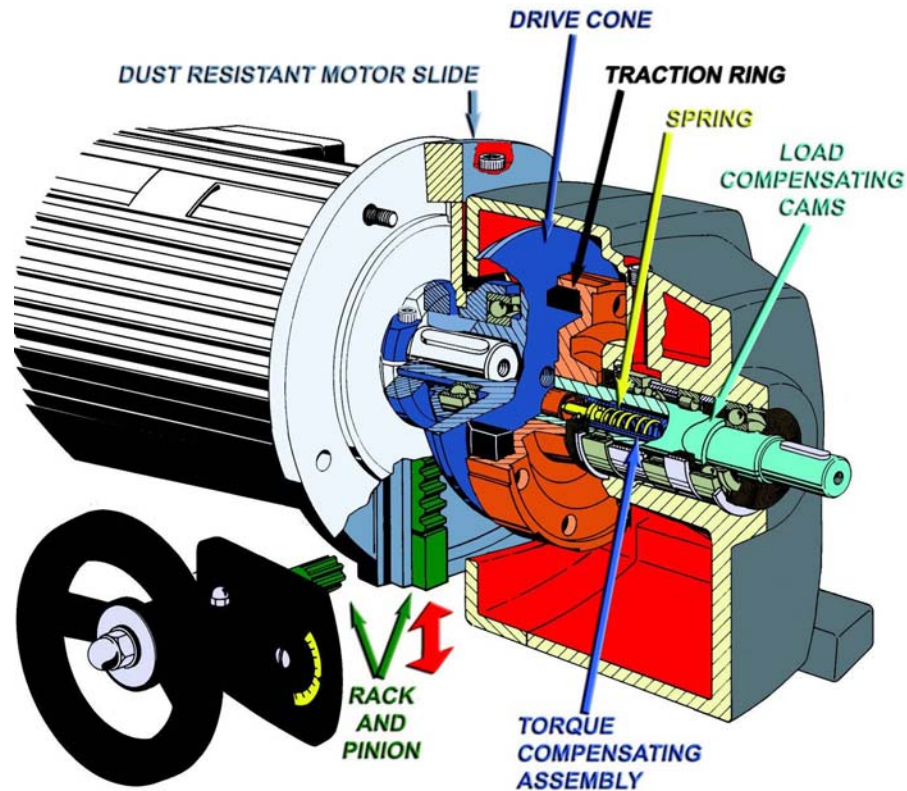

Operation:

The ComTrac drive is an adjustable speed traction drive. Its operation is based upon the transfer of power between the motor mounted **drive cone** and the **traction ring**. The **drive cone** and the **traction ring** are forced together to transmit torque through the use of a **spring loaded torque compensator assembly**.

At rest, the **spring** inside the **torque compensator** produces only a small contact pressure between the **drive cone** and **traction ring**. Unlike other mechanical drives, the minimal spring pressure allows speed changes to be made while the drive is at rest.

As the drive is started, the **load compensating cams** move against each other to increase pressure between the **drive cone** and **traction ring**. During operation, the **load compensating cams** maintain the proper amount of pressure between the **drive cone** and **traction ring** in proportion to the output load torque required.

Speed changes are made by changing the relative running diameters of the **drive cone** and the **traction ring**. As the motor and **drive cone** are moved upward, the contact point between the **cone** and **ring** moves to the faster running outer diameter of the **drive cone** and output speed increases. As the motor and **drive cone** are lowered, the contact point between the **cone** and **ring** moves to the slower running center of the **drive cone** and output speed decreases.

Movement of the motor and **drive cone** are accomplished through the use of a **handwheel** attached to a **rack and pinion**. By turning the **handwheel**, the motor is easily raised or lowered on the **dust resistant motor slide**. Speed changes can also be made through the use of an optional electric remote control which replaces the **handwheel**.

Speed Control Made Simple!

- Turn the handwheel — pinion moves the rack on the motor slide — up or down.

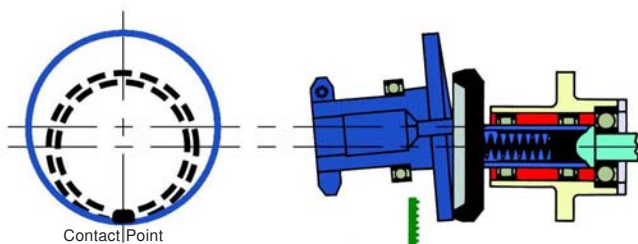

Maximum speed — motor slide up.

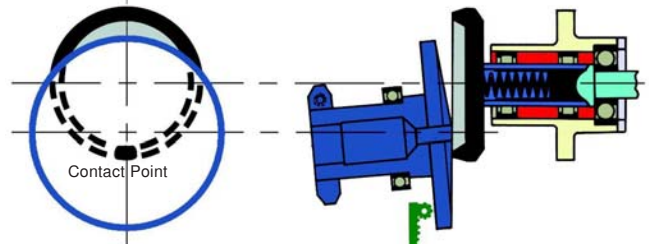

Minimum speed — motor slide down.



ComTrac® Adjustable Speed Drives

.50 HP @ 1750 RPM



All TD27 units are available with 56C and 143TC input.

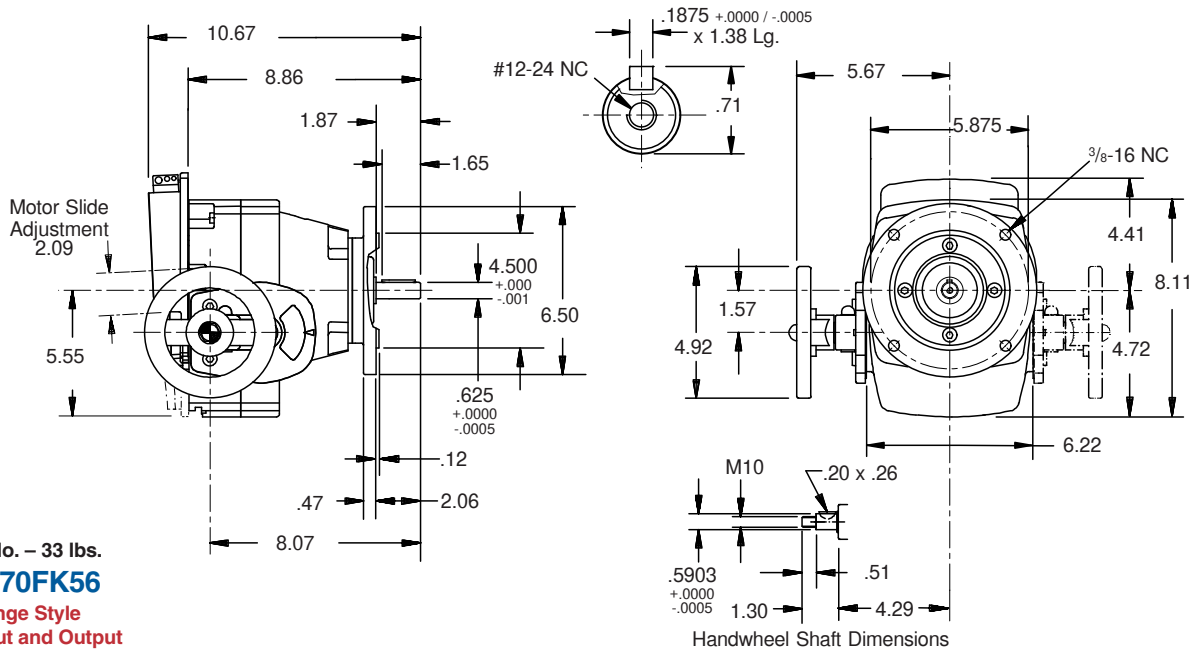

Part No. – 33 lbs.
TD270FK56
 Flange Style
 56C Input and Output

Constant Horsepower Range			Constant Torque Range					
MAXIMUM RPM ⁽¹⁾	in.lbs.	HP	TRANSITION ⁽²⁾ RPM ⁽¹⁾	in.lbs.	HP	MINIMUM RPM ⁽¹⁾	in.lbs.	HP
2,180	12.2	0.42	334	66	0.35	311	66	0.33

All ratings shown are based on 1750 RPM motor speed and are rated to provide constant torque through the entire speed range. Contact STÖBER for constant horsepower applications. **MOTOR MUST BE ORDERED SEPARATELY.**

¹⁾ Speed tolerance at rated load is ±3%. At less than rated load, minimum speed may increase 5%.

²⁾ The ComTrac drive operates at constant horsepower above transition values and at constant torque below transition values. Note shaded area. Engineering advances may cause slight changes to the information shown.

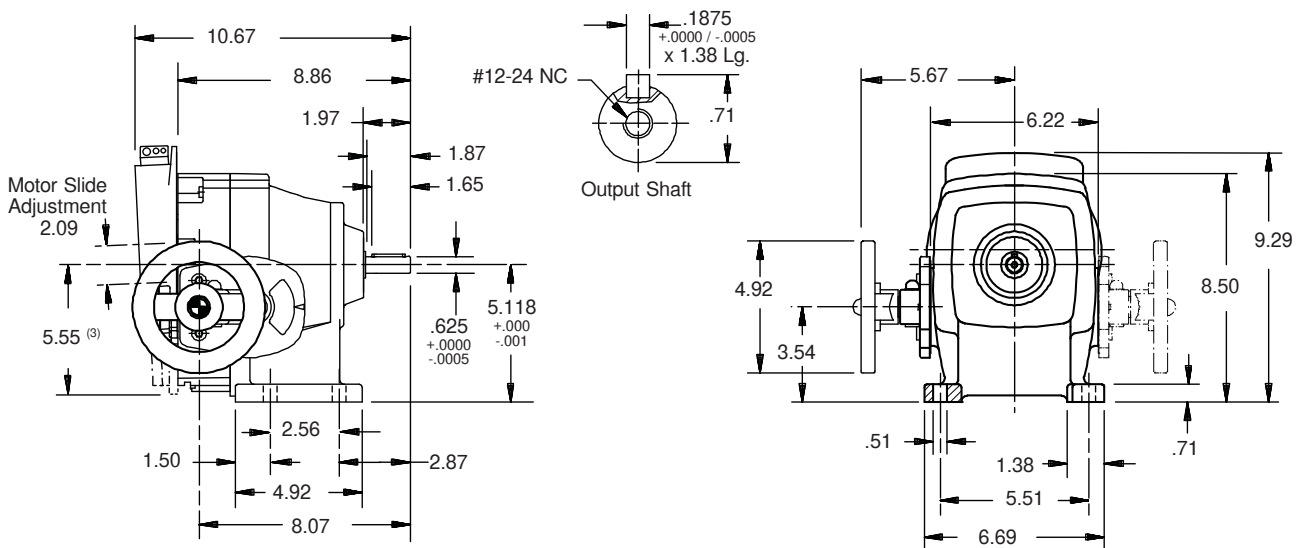

Part No. – 33 lbs.
TD270NK56
 Foot Mount
 56C Input

⁽³⁾ Motor is lower than the base of the ComTrac. See Page 15.



ComTrac® Adjustable Speed Drives

.75 HP @ 1750 RPM



All TD27 units are available with 56C and 143TC input.

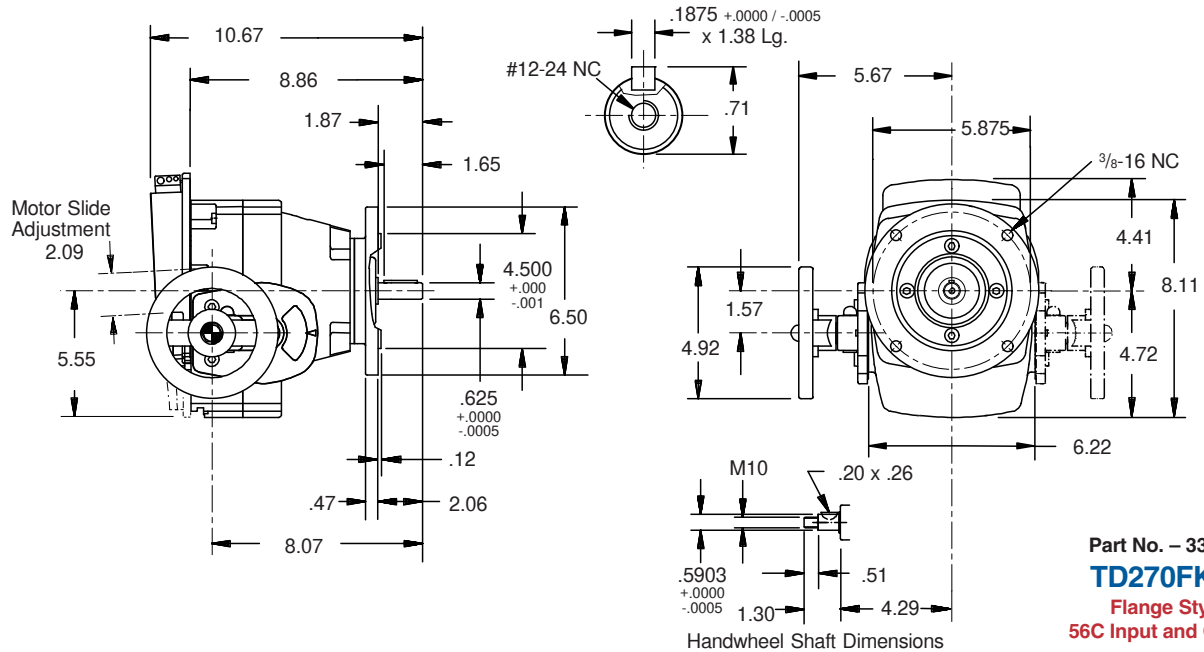

Constant Horsepower Range			Constant Torque Range					
RPM ⁽¹⁾	MAXIMUM		TRANSITION ⁽²⁾			MINIMUM		
	in.lbs.	HP	RPM ⁽¹⁾	in.lbs.	HP	RPM ⁽¹⁾	in.lbs.	HP
2,180	18.3	0.63	582	66	0.61	311	66	0.33

All ratings shown are based on 1750 RPM motor speed and are rated to provide constant torque through the entire speed range. Contact STÖBER for constant horsepower applications. **MOTOR MUST BE ORDERED SEPARATELY.**

¹⁾ Speed tolerance at rated load is ±3%. At less than rated load, minimum speed may increase 5%.

²⁾ The ComTrac drive operates at constant horsepower above transition values and at constant torque below transition values. Note shaded area. Engineering advances may cause slight changes to the information shown.

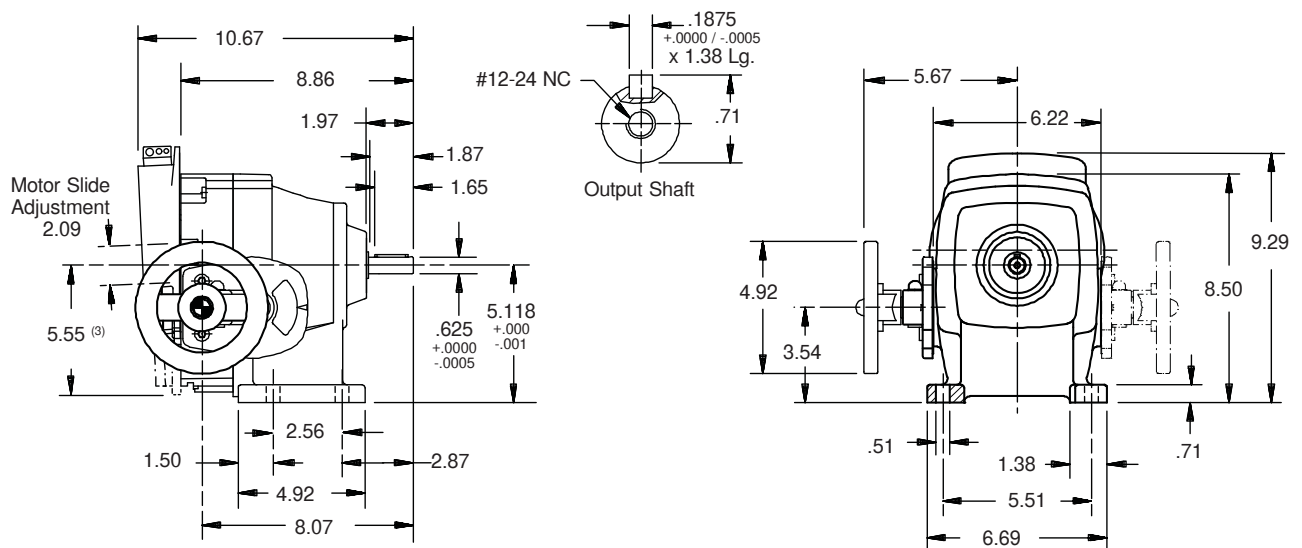

⁽³⁾ Motor is lower than the base of the ComTrac. See Page 15.



ComTrac® Adjustable Speed Drives

1.0 HP @ 1750 RPM



All TD27 units are available with 56C and 143TC input.

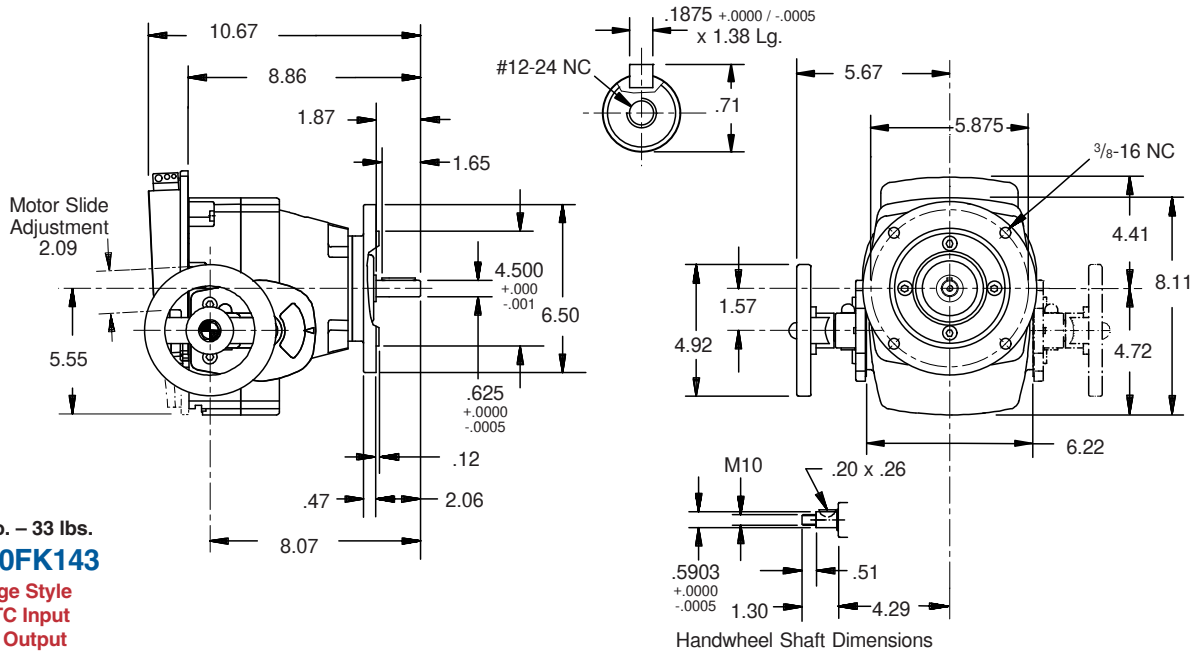

Part No. – 33 lbs.
TD270FK143
 Flange Style
 143TC Input
 56C Output

Constant Horsepower Range			Constant Torque Range					
MAXIMUM RPM ⁽¹⁾	in.lbs.	HP	TRANSITION ⁽²⁾ RPM ⁽¹⁾	in.lbs.	HP	MINIMUM RPM ⁽¹⁾	in.lbs.	HP
2,180	24.4	0.84	821	66	0.86	311	66	0.33

All ratings shown are based on 1750 RPM motor speed and are rated to provide constant torque through the entire speed range. Contact STÖBER for constant horsepower applications. **MOTOR MUST BE ORDERED SEPARATELY.**

¹⁾ Speed tolerance at rated load is ±3%. At less than rated load, minimum speed may increase 5%.

²⁾ The ComTrac drive operates at constant horsepower above transition values and at constant torque below transition values. Note shaded area. Engineering advances may cause slight changes to the information shown.

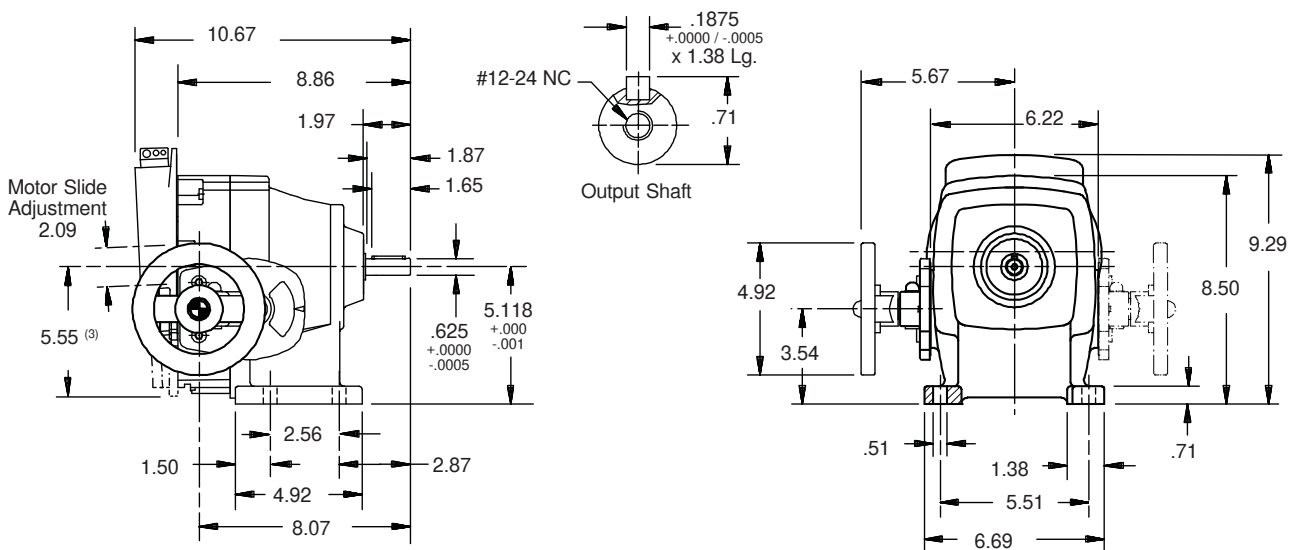

Part No. – 33 lbs.
TD270NK143
 Foot Mount
 143TC Input

⁽³⁾ Motor is lower than the base of the ComTrac. See Page 15.



ComTrac® Adjustable Speed Drives

1.5 HP @ 1750 RPM

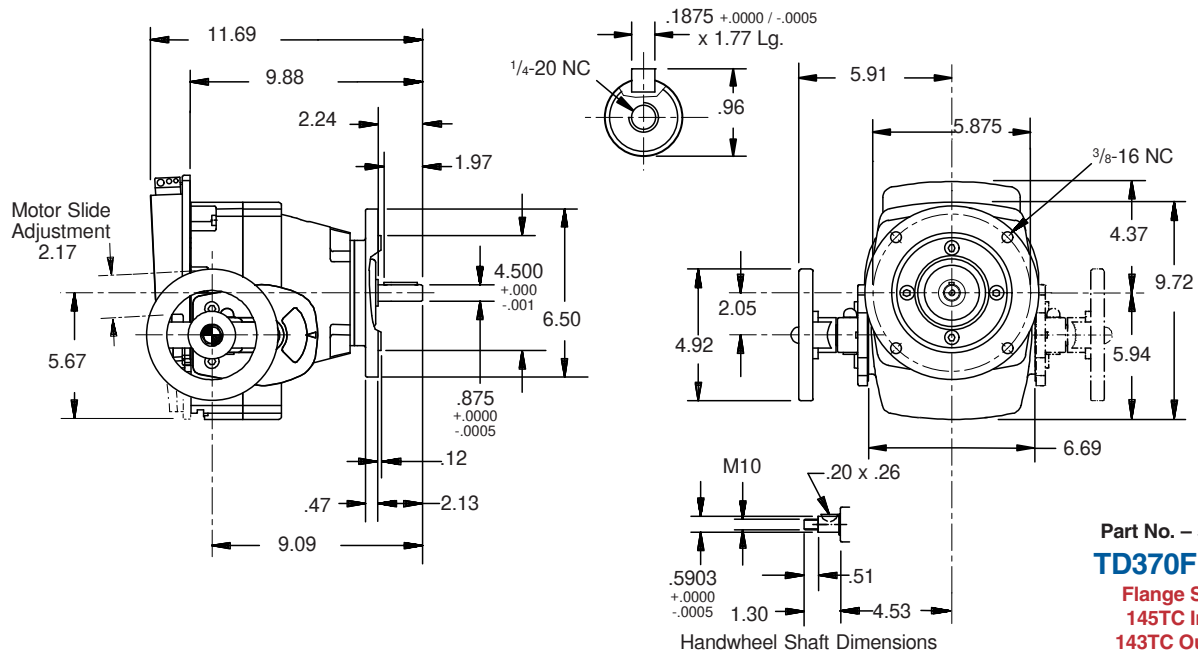

Part No. – 51 lbs.
TD370FK145
 Flange Style
 145TC Input
 143TC Output

Constant Horsepower Range			Constant Torque Range		
RPM ⁽¹⁾	in.lbs.	HP	RPM ⁽¹⁾	in.lbs.	HP
2,100	38	1.27	856	97	1.31
			420	97	0.64

All ratings shown are based on 1750 RPM motor speed and are rated to provide constant torque through the entire speed range. Contact STÖBER for constant horsepower applications. **MOTOR MUST BE ORDERED SEPARATELY.**

¹⁾ Speed tolerance at rated load is ±3%. At less than rated load, minimum speed may increase 5%.

²⁾ The ComTrac drive operates at constant horsepower above transition values and at constant torque below transition values. Note shaded area. Engineering advances may cause slight changes to the information shown.

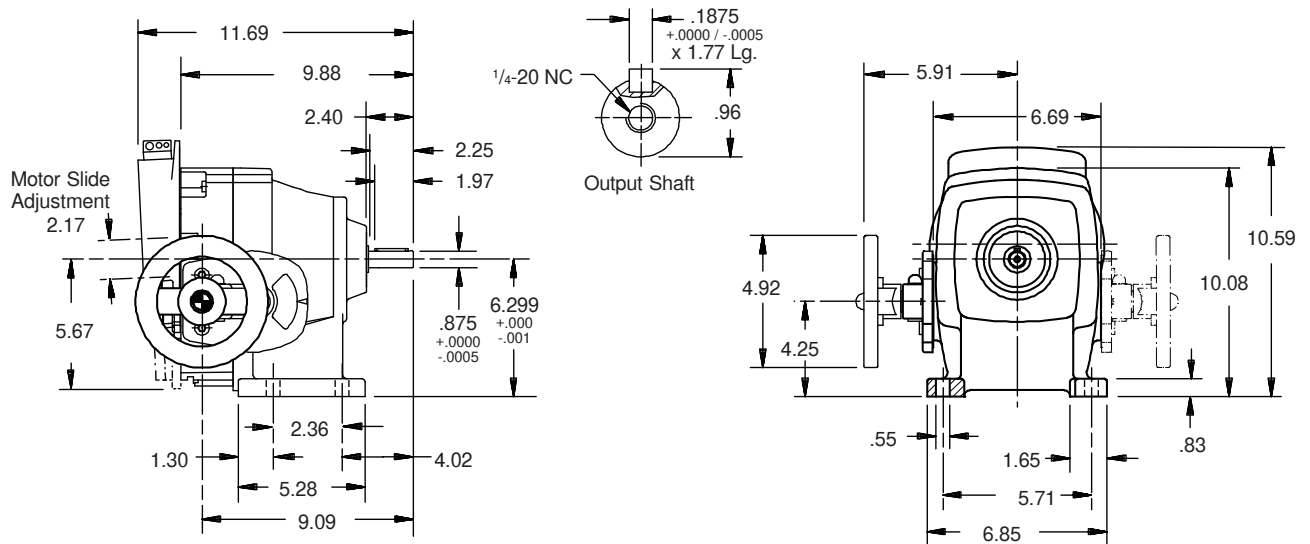

Part No. – 51 lbs.
TD370NK145
 Foot Mount
 145TC Input



ComTrac® Adjustable Speed Drives

2.0 HP @ 1750 RPM

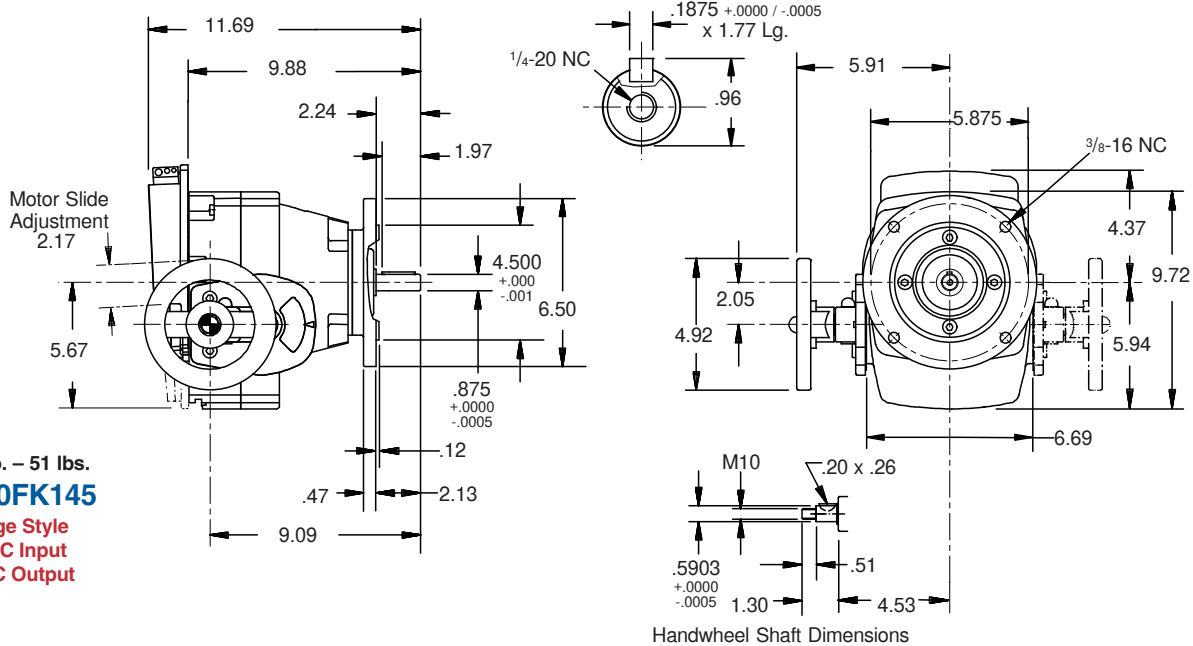

Part No. – 51 lbs.
TD370FK145
 Flange Style
 145TC Input
 143TC Output

Constant Horsepower Range			Constant Torque Range					
MAXIMUM	TRANSITION ⁽²⁾		MINIMUM					
RPM ⁽¹⁾	in.lbs.	HP	RPM ⁽¹⁾	in.lbs.	HP			
2,100	51	1.70	1,162	97	1.79	420	97	0.65

All ratings shown are based on 1750 RPM motor speed and are rated to provide constant torque through the entire speed range. Contact STÖBER for constant horsepower applications. **MOTOR MUST BE ORDERED SEPARATELY.**

¹⁾ Speed tolerance at rated load is ±3%. At less than rated load, minimum speed may increase 5%.

²⁾ The ComTrac drive operates at constant horsepower above transition values and at constant torque below transition values. Note shaded area. Engineering advances may cause slight changes to the information shown.

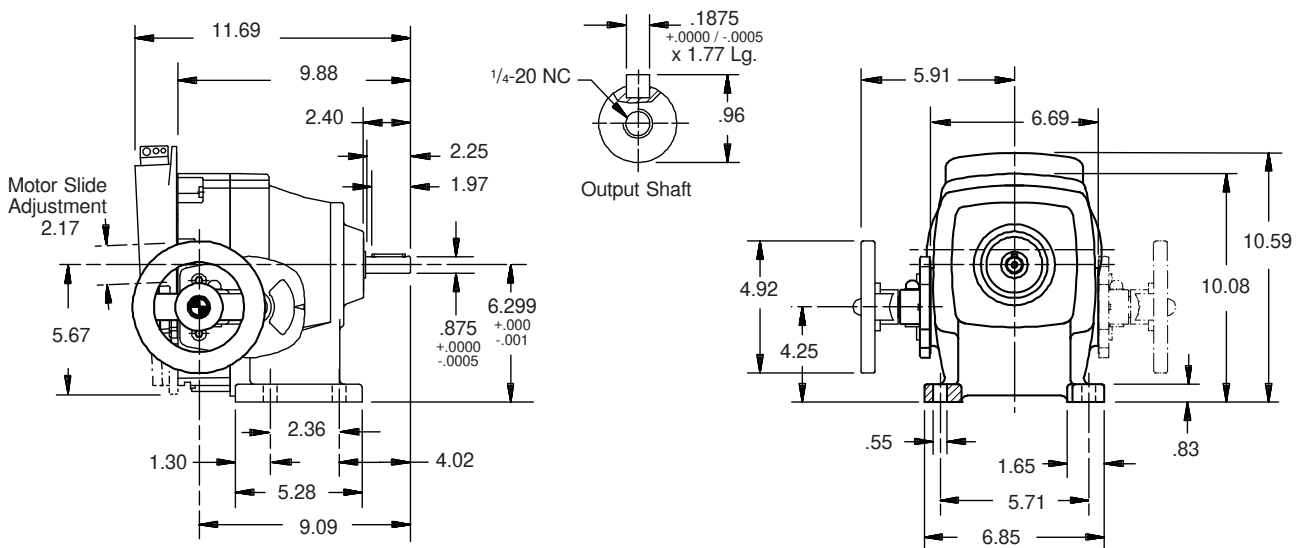

Part No. – 51 lbs.
TD370NK145
 Foot Mount
 145TC Input



ComTrac® Adjustable Speed Drives

3.0 HP @ 1750 RPM

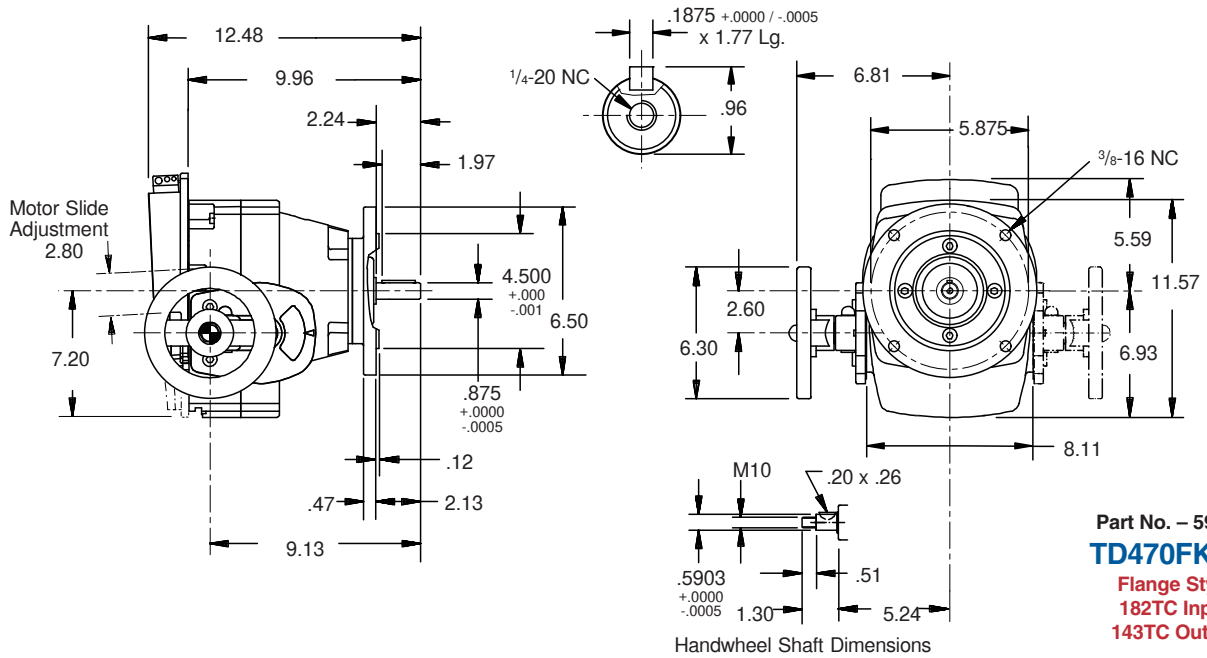

Part No. – 59 lbs.
TD470FK182
 Flange Style
 182TC Input
 143TC Output

Constant Horsepower Range			Constant Torque Range					
MAXIMUM RPM ⁽¹⁾	in.lbs.	HP	TRANSITION ⁽²⁾ RPM ⁽¹⁾	in.lbs.	HP	MINIMUM RPM ⁽¹⁾	in.lbs.	HP
2,100	81	2.70	970	177	2.72	420	177	1.18

All ratings shown are based on 1750 RPM motor speed and are rated to provide constant torque through the entire speed range. Contact STÖBER for constant horsepower applications. **MOTOR MUST BE ORDERED SEPARATELY.**

¹⁾ Speed tolerance at rated load is $\pm 3\%$. At less than rated load, minimum speed may increase 5%.

²⁾ The ComTrac drive operates at constant horsepower above transition values and at constant torque below transition values. Note shaded area. Engineering advances may cause slight changes to the information shown.

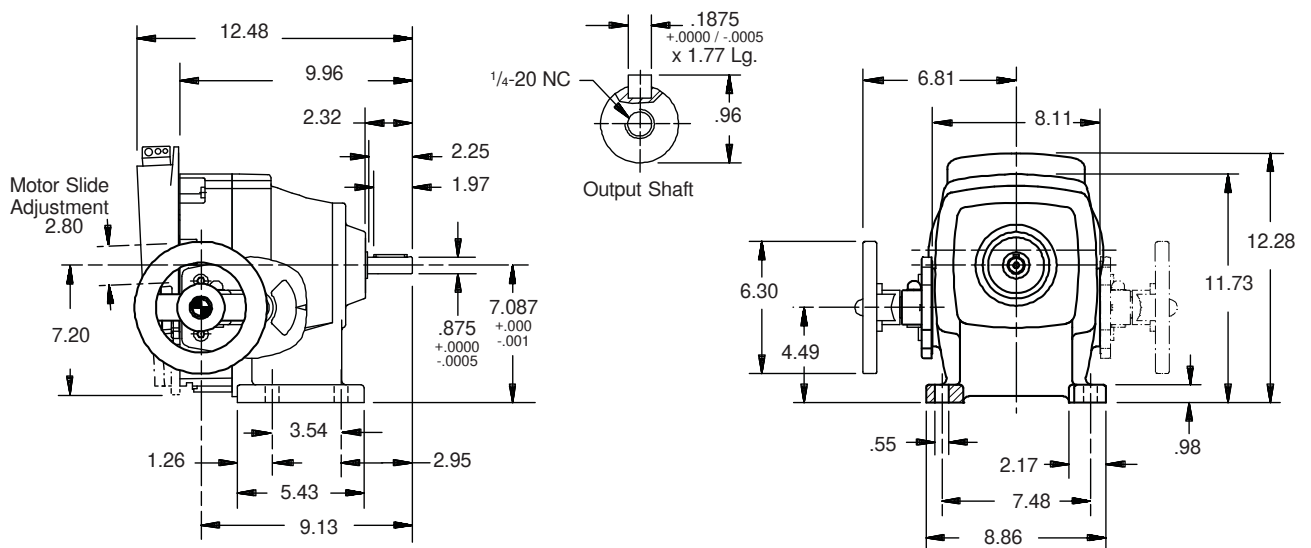

Part No. – 59 lbs.
TD470NK182
 Foot Mount
 182TC Input



ComTrac® Adjustable Speed Drives

5.0 HP @ 1750 RPM

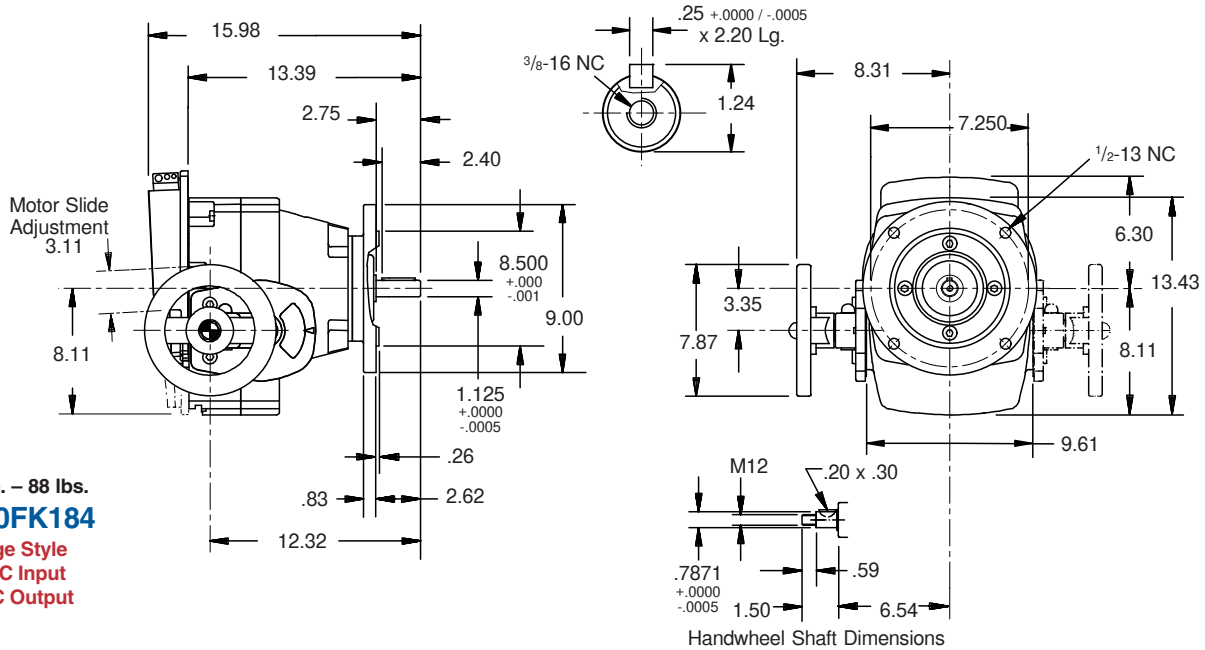

Part No. – 88 lbs.
TD570FK184
 Flange Style
 184TC Input
 182TC Output

Constant Horsepower Range			Constant Torque Range					
MAXIMUM	TRANSITION ⁽²⁾		MINIMUM					
RPM ⁽¹⁾	in.lbs.	HP	RPM ⁽¹⁾	in.lbs.	HP			
2,100	137	4.56	1,102	266	4.65	420	266	1.77

All ratings shown are based on 1750 RPM motor speed and are rated to provide constant torque through the entire speed range. Contact STÖBER for constant horsepower applications. **MOTOR MUST BE ORDERED SEPARATELY.**

¹⁾ Speed tolerance at rated load is ±3%. At less than rated load, minimum speed may increase 5%.

²⁾ The ComTrac drive operates at constant horsepower above transition values and at constant torque below transition values. Note shaded area. Engineering advances may cause slight changes to the information shown.

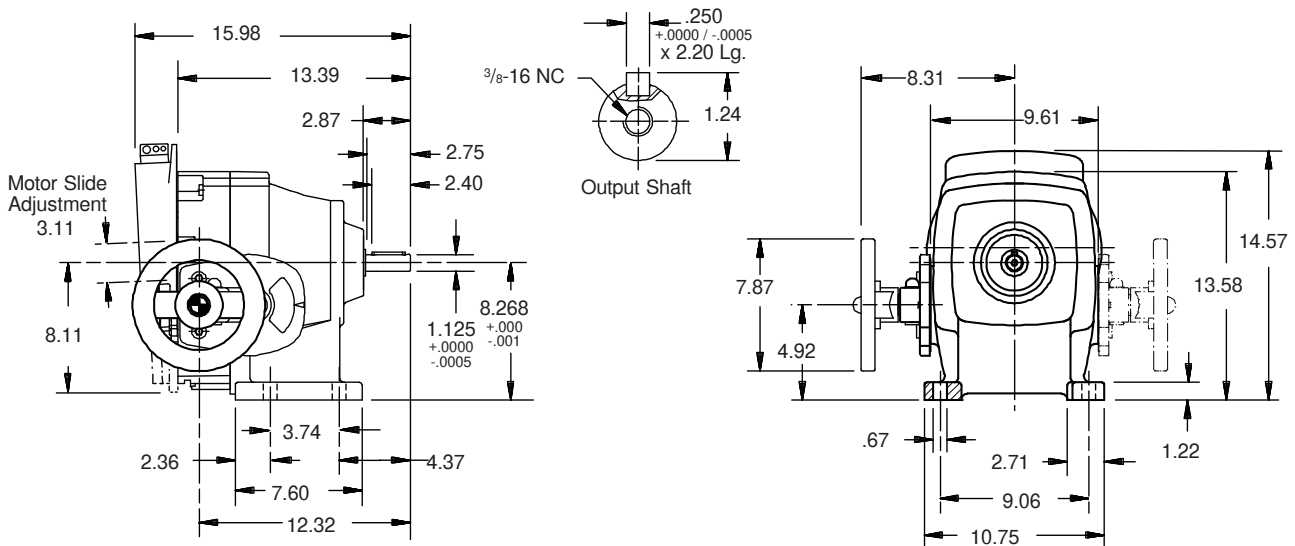

Part No. – 88 lbs.
TD570NK184
 Foot Mount
 184TC Input



ComTrac[®] Adjustable Speed Drives

7.5 HP @ 1750 RPM

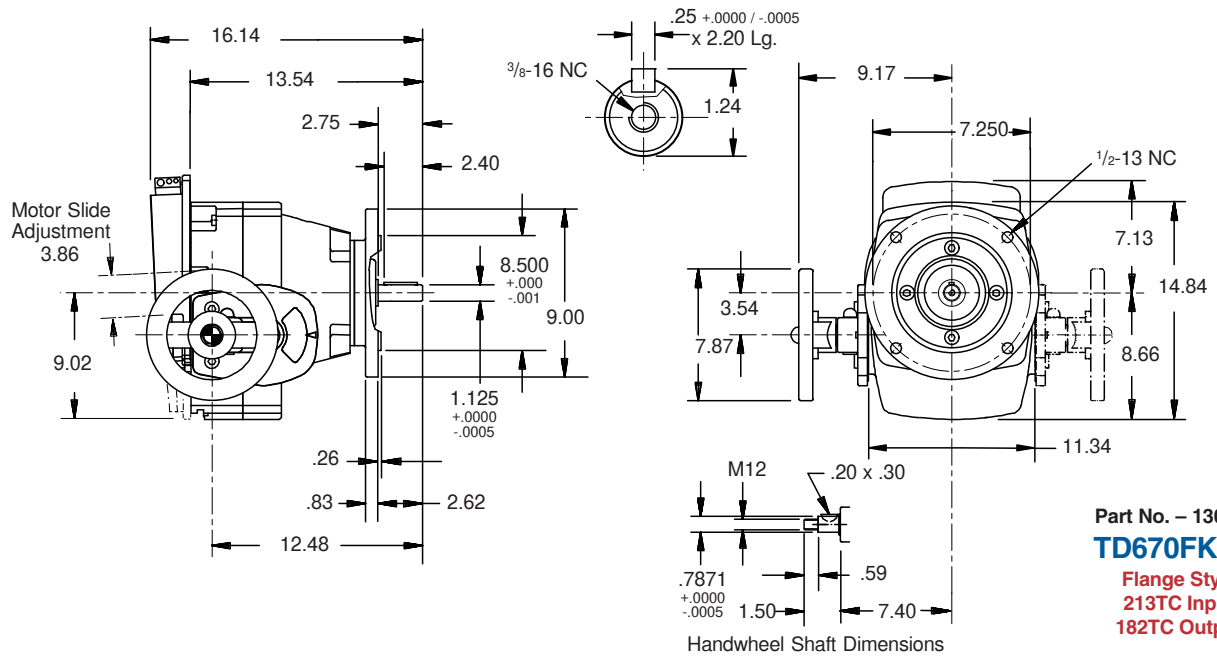

Part No. – 130 lbs.
TD670FK213
 Flange Style
 213TC Input
 182TC Output

Constant Horsepower Range			Constant Torque Range					
MAXIMUM RPM ⁽¹⁾	in.lbs.	HP	TRANSITION ⁽²⁾ RPM ⁽¹⁾	in.lbs.	HP	MINIMUM RPM ⁽¹⁾	in.lbs.	HP
2,100	206	6.86	1,216	363	7.00	420	363	2.42

All ratings shown are based on 1750 RPM motor speed and are rated to provide constant torque through the entire speed range. Contact STÖBER for constant horsepower applications. **MOTOR MUST BE ORDERED SEPARATELY.**

- Speed tolerance at rated load is $\pm 3\%$. At less than rated load, minimum speed may increase 5%.
- The ComTrac drive operates at constant horsepower above transition values and at constant torque below transition values. Note shaded area. Engineering advances may cause slight changes to the information shown.

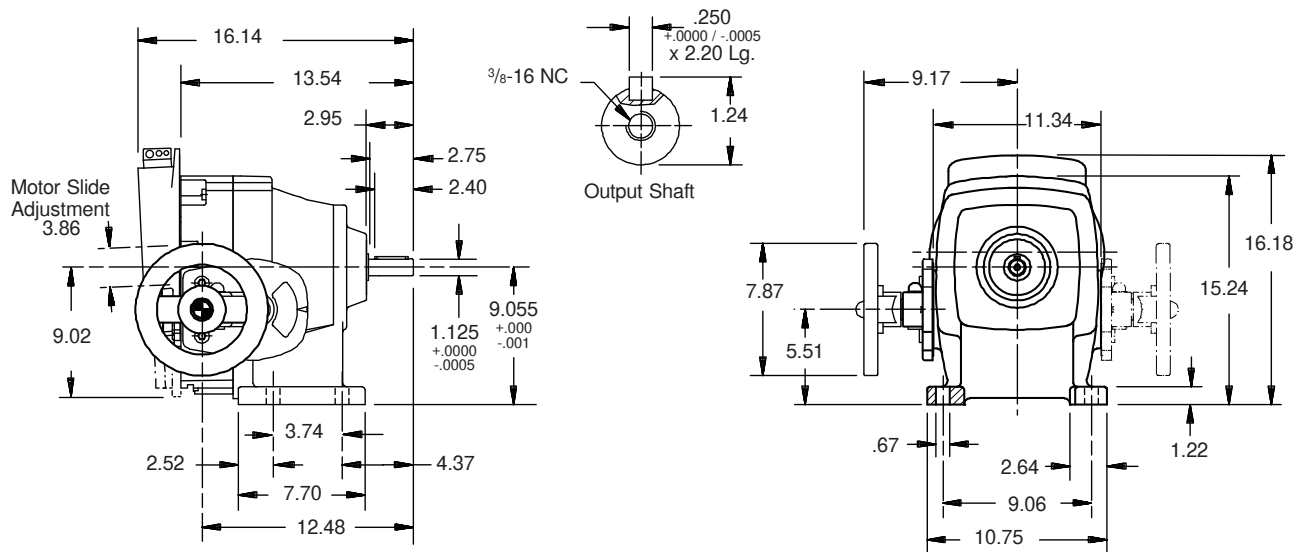

Part No. – 130 lbs.
TD670NK213
 Foot Mount
 213TC Input



ComTrac® Adjustable Speed Drives

10.0 HP @ 1750 RPM

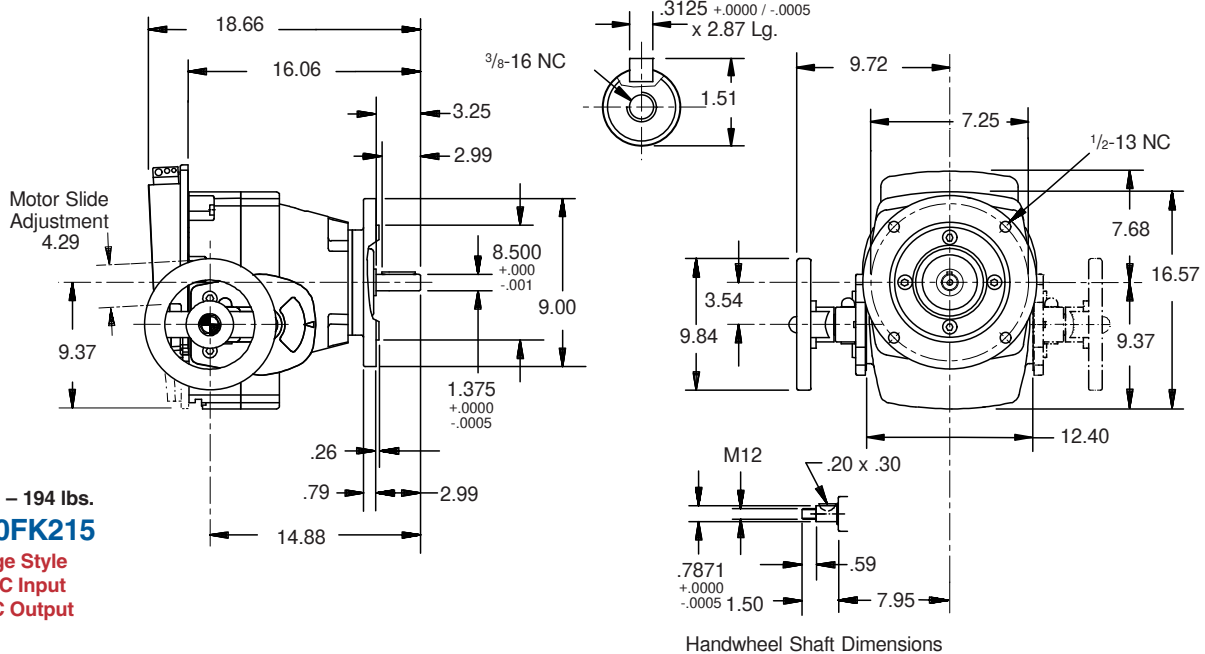

Part No. – 194 lbs.
TD760FK215
 Flange Style
 215TC Input
 213TC Output

Handwheel Shaft Dimensions

Constant Horsepower Range			Constant Torque Range					
MAXIMUM		HP	TRANSITION ⁽²⁾		MINIMUM			
RPM ⁽¹⁾	in.lbs.		RPM ⁽¹⁾	in.lbs.	RPM ⁽¹⁾	in.lbs.		
2,160	274	9.4	1,200	496	9.4	430	496	3.3

All ratings shown are based on 1750 RPM motor speed and are rated to provide constant torque through the entire speed range. Contact STÖBER for constant horsepower applications. **MOTOR MUST BE ORDERED SEPARATELY.**

¹⁾ Speed tolerance at rated load is ±3%. At less than rated load, minimum speed may increase 5%.

²⁾ The ComTrac drive operates at constant horsepower above transition values and at constant torque below transition values. Note shaded area. Engineering advances may cause slight changes to the information shown.

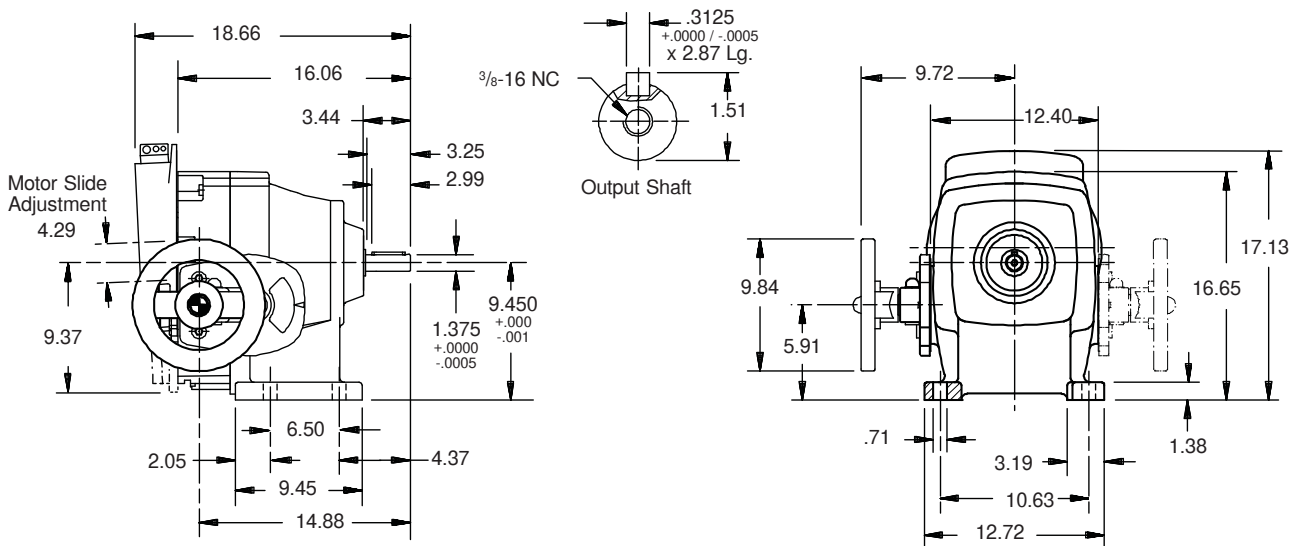

Part No. – 194 lbs.
TD760NK215
 Foot Mount
 215TC Input



ComTrac® Adjustable Speed Drives Electric Remote Control



The STÖBER Electric Remote Control (ERC) is a compact double reduction gearmotor which is pinion mounted to the motor slide track in place of the handwheel. A mechanical clutch within the unit indicates the end of vertical motor travel in both directions by making a clicking noise.

The ERC can be operated by push button or other type of control (not included) to adjust the drive's speed. In many applications it is advisable to use a limit switch with the ERC to prevent overspeed or underspeed conditions.

Features:

- Speed changes can be made when the unit is stationary or running.
- STÖBER ERC can be quickly and easily added to existing ComTrac drives without special tools.
- All STÖBER ERC units are designed for washdown/severe duty applications and are available from stock.
- Available voltages:
 - 115V, single phase, 60 Hz
 - 230/460V, three phase, 60 Hz

Table No. 1 ERC – Dimensions (Inches)

ComTrac Size	Model Number		A	B	C
	Single Phase	Three Phase			
TD27	ERC27-1	ERC27-2	6.18	7.09	9.72
TD37	ERC37-1	ERC37-3	6.14	7.05	9.68
TD47	ERC47-1	ERC47-3	7.12	8.03	10.67
TD57	ERC57-1	ERC57-3	7.56	9.06	11.10
TD67	ERC67-1	ERC67-3	8.42	10.04	11.97
TD76	ERC76-1	ERC76-3	8.98	10.43	14.69

Motor dimensions may vary slightly from values shown.

⦿ Reference point for handwheel center.

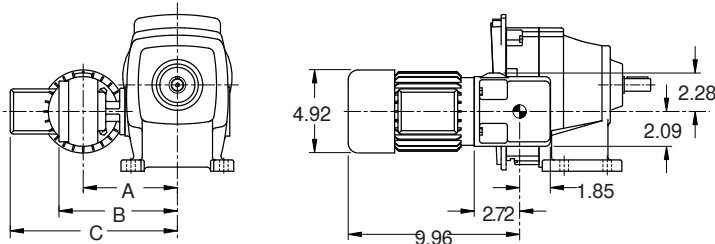

ERC for ComTrac sizes: TD27, TD37, and TD47.

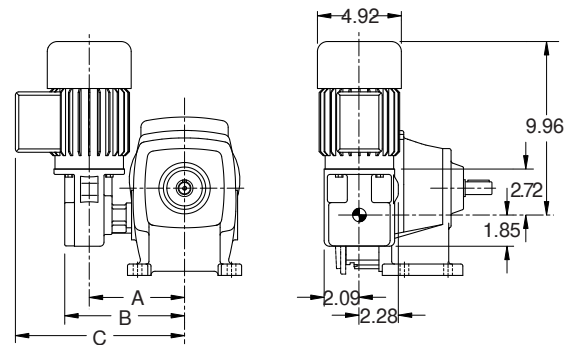

ERC for ComTrac sizes: TD57, TD67, and TD76.

Motor Clearance

On some TD27 ComTrac units, the motor can be lower than the base of the unit when adjusted to the slowest setting. The following formula will determine a value based on the length of the motor to be installed.

$$XX = .055 \times B \text{ (When "B" = motor length)}$$

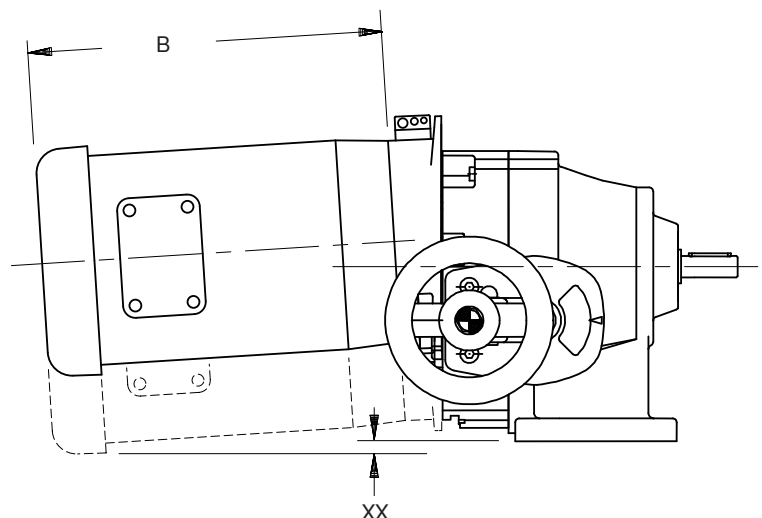

ComTrac[®] Adjustable Speed Drives Selection and Performance Characteristics



Selection:

The ComTrac drives shown in the selection tables are rated for constant torque operation — where required horsepower varies directly in proportion to the speed of the driven machine.

All ratings shown are based upon standard NEMA C-face motor designs with 1750 RPM input speed. Contact STÖBER technical support for selection assistance for motor speeds other than 1750 RPM.

Basic selection procedure is as follows:

1. Establish the maximum horsepower required by the driven machine at maximum speed.

If only the driven equipment's maximum torque (T) requirement is known, use the following formula to convert the torque value to horsepower:

$$HP = \frac{T \times RPM}{63,025}$$

2. Select the drive which meets or exceeds the maximum HP rating of the driven machine at maximum speed.

Since the typical ComTrac application requires constant torque over the entire speed range, there will be an adequate service factor to protect the traction ring from damage.

Use the output speed ratings shown in the tables to select an output speed which meets or exceeds the requirement of the driven machine. Read across the table to determine if the drive's actual minimum and maximum speed, torque, and horsepower ratings meet the requirements of the driven equipment.

If the maximum output speed shown in the table is too low, go to the next higher speed. Should the torque or horsepower ratings shown be below the driven equipment's requirements, consult the next higher horsepower rating in the selection data.

Motor Performance

The ratings shown in the ComTrac selection tables are based on standard NEMA motors with the following specifications:

- 1750 RPM speed
- 60 Hz operation

Application Matched Options

Several options for ComTrac drives, such as remote controls, are included in this catalog. In addition, the following options are also available:

- 50 Hz operation for export
- Motor enclosures

For application and selection assistance for these options and others, contact your local STÖBER distributor.

Non-Standard Application Conditions

For constant horsepower applications, or any of the nonstandard application conditions shown below, contact STÖBER technical support.

Unusual Loading Conditions:

- Heavy shock load
- High inertia load
- Load reversals or overhauling loads
- More than ten starts per hour

Unusual Environmental Conditions:

- High altitudes — above 5000 feet
- Corrosive chemicals

- Excessively dusty or abrasive environments
 - Ambient temperatures below 25° F or above 125° F
- Nonstandard Motors:

- Motor frame sizes other than those shown in the tables
- Nonstandard Mounting:

- Output shaft up or down (V5 or V6 mounting)

Not Recommended for Mounting:

- Explosive environment of any type

Performance Characteristics

Because of its mechanical operation, the ComTrac drive generally produces constant output torque. While the induction motor produces constant horsepower and constant speed, the two are combined in a manner that provides optimum utility and economy.

As the ComTrac Performance Chart shows, the drive has two operating regions.

1. Constant torque between the drive's absolute minimum speed and transition speed.
2. Constant horsepower between the transition speed and maximum speed.

When selecting a ComTrac drive, it is important to choose a unit which will not allow the cone and ring system to be overpowered by the motor. As shown in the ComTrac Performance Chart, ComTrac drives should always be selected so that the output torque required is well below the torque capability of the cone and the ring system.

Graph No. 1 ComTrac Performance Chart

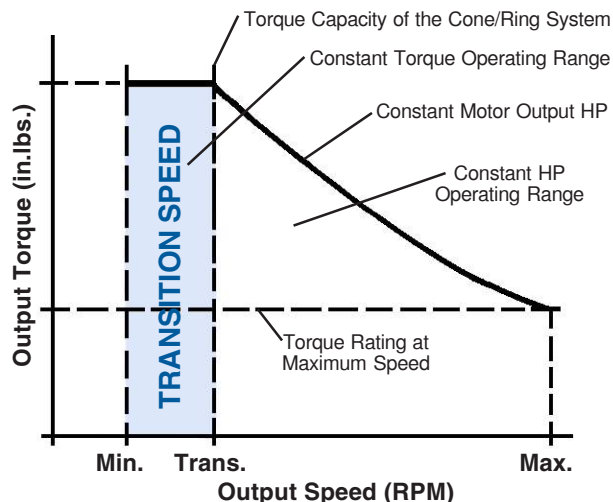



ComTrac® Adjustable Speed Drives Selection and Performance Characteristics

Overhung Loads

When a belt, chain, or gear is mounted on the output shaft of a ComTrac drive, the overhung load effect of the drive must not exceed the ratings shown in the Overhung Load Capacity table shown below.

To calculate the overhung load of the drive mounted on the output shaft, use the following formula:

$$OHL = \frac{126,000 \times HP \times K}{D \times RPM}$$

OHL = Overhung Load (lbs.)

HP = Horsepower

D = Pitch Diameter (inches) of sprocket, gear, sheave or pulley

K = 1.00 Chain Drive

1.25 Gear Drive or Gearbelt Pulley Drive

1.50 V-belt Drive

2.50 Flat Belt Drive

RPM = Maximum Speed (Revolutions per Minute)

No overhung loads are encountered when the ComTrac drive is direct coupled to a C-face speed reducer or when the ComTrac drive is connected by a coupling to the driven machine. However, care should be taken to properly align the shafts to prevent pre-loading of the bearings.

Table No. 1

ComTrac Overhung Load Capacities (lbs) ⁽¹⁾

ComTrac Series ON, Non-Gear

Size	Output Shaft Speed (RPM)									
	2100	1800	1600	1400	1200	1000	800	600	450	300
TD27-0	152	158	166	174	182	191	202	219	238	270
TD37-0	242	248	258	270	284	300	316	338	371	411
TD47-0	302	312	324	338	353	371	393	425	461	517
TD57-0	382	393	405	416	430	450	483	517	562	629
TD67-0	494	500	510	528	550	584	630	675	730	810
TD76-0	650	660	680	700	735	770	820	880	950	1080

Graph No. 2 ComTrac Series 0F Output HP

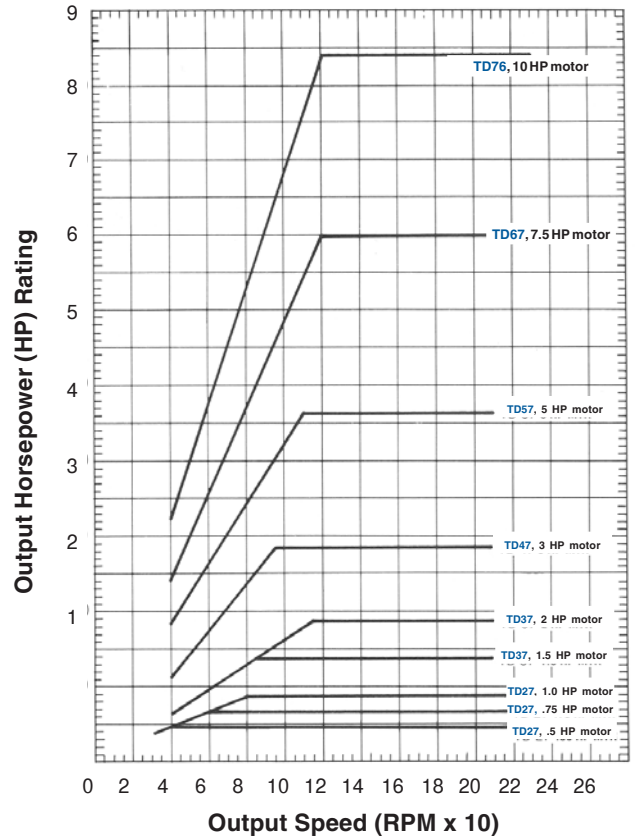

Table No. 2

ComTrac Series 0F Specifications

Motor HP	NEMA Frame	Output Torque in.lbs.	Model Number	C-Face Output Flange	Speed Range	Output Speed Range (RPM)	
						Max.	Min.
.50	56C	16	TD270F	56C	7:1	2180	311
.75	56C	24	TD270F	56C	7:1	2180	311
1.00	143TC	32	TD270F	56C	7:1	2180	311
1.50	145TC	48	TD370F	143/145TC	5:1	2100	420
2.00	145TC	64	TD370F	143/145TC	5:1	2100	420
3.00	182TC	99	TD470F	143/145TC	5:1	2100	420
5.00	184TC	168	TD570F	182/184TC	5:1	2100	420
7.50	213TC	250	TD670F	182/184TC	5:1	2100	420
10.00	215TC	340	TD760F	213/215TC	5:1	2100	420

Minimum output torque rating based on 1750 RPM maximum input speed,

ComTrac® Adjustable Speed Drives Installation Instructions



Unit Installation

ComTrac Series 0N

Units with integral mounting feet and are designed to be mounted on rigid foundations. All housing feet must rest firmly on supports before being bolted down. Use shims to level the drive and proper size foundation bolts to secure the drive to the foundation. Use flat washers between the heads of the bolts and the housing feet.

These drives can be horizontal, wall, ceiling, or vertically mounted without concern for lubrication or other modification.

If vertical mounting (output shaft up or down) is required, consult STÖBER Drives Inc. at the time of purchase.



ComTrac Series 0F

Units with C-face input and output are designed to attach to any speed reducer with a NEMA C-face input. Care must be taken to follow the speed reducer manufacturer's recommended mounting instructions.

NOTE: ComTrac Series 0F drives do not have mounting feet. The drive and motor assembly is mounted on the speed reducer which must support the reducer, ComTrac, and the motor. If there is concern for the ability of the reducer mounting feet to support the entire assembly, a larger speed reducer may be required.

The output shaft of the ComTrac drive is shipped from the factory with a protective coating. Remove this coating with a suitable nonflammable solvent. Precaution must be taken not to allow the solvent to contact the output shaft oil seal, since damage to the seal may occur.



Motor Installation

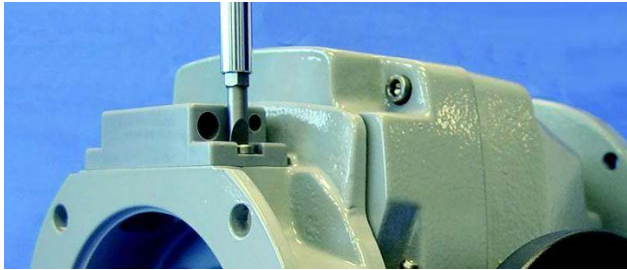

Step 1 — Remove the access cover.



Step 2 — Lubricate and insert keyed motor shaft into the slotted bore of the drive cone shaft.

NOTE: For ease of installation, secure the key to the motor shaft. (Staking near the end of the keyway or a temporary adhesive works well.)



Step 3 — Tighten the four motor flange bolts.

IMPORTANT: Jog the motor several revolutions before tightening the motor clamp to assure proper position of the drive cone on the motor shaft. See Page 5 for illustration.

Step 4 — Through the access hole, tighten the hex socket screw on the motor clamp hub to the tightening torque shown in the table below. The correct size hex wrench is provided. **DO NOT OVERTIGHTEN.**

SHOWN WITHOUT MOTOR FOR DEMONSTRATION.



Table No. 1

Clamp Ring Setscrew Tightening Torque

ComTrac Size	in. lbs.	ComTrac Size	in. lbs.
TD27	88.5	TD57	434
TD37	88.5	TD67	434
TD47	221	TD76	434

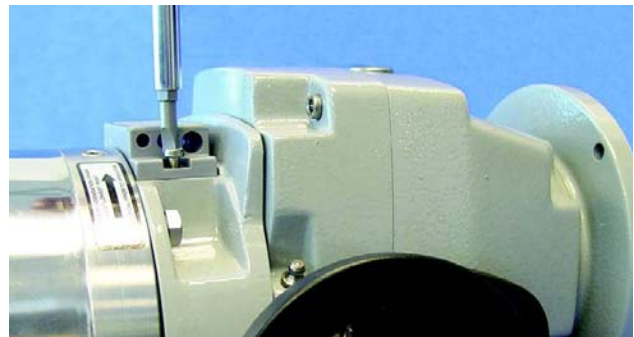

Step 5 — Reattach access cover.

When couplings, gears, sprockets or pulleys are mounted on the output shaft, be sure to mount them as close as possible to the housing to minimize the effects of overhung loads on shafts and bearings.

CAUTION: Do not drive couplings, sprockets, gears or pulleys onto the output shaft with hard hammer blows, since damage to internal gears or bearings will result. All output shafts have a metric centering thread for attachment of transmission devices. They can be pulled on gently with a bolt and plate.



ComTrac® Adjustable Speed Drives Installation Instructions

Handwheel Position

ComTrac drives are furnished with the speed control handwheel on the left, as viewed from the output shaft end of the drive. If it is necessary that the handwheel be moved to the opposite side, this can be accomplished very easily with the hex wrenches provided with each drive.

Procedure for Changing Handwheel Position:

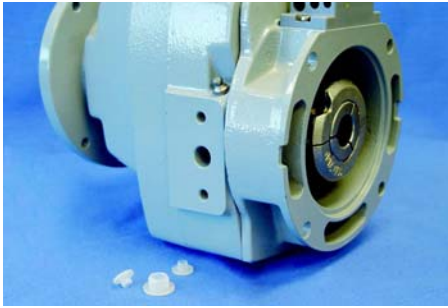

Step 1 — Remove the three (3) plastic plugs in the housing on the side opposite the handwheel.

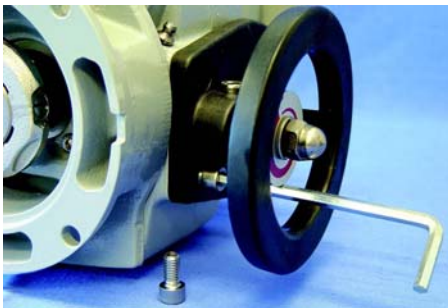

Step 2 — Remove the handwheel and indicator assembly by removing the two (2) socket-head capscrews which secure the handwheel indicator assembly to the housing.

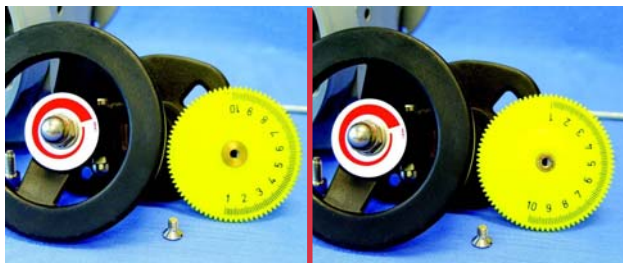

Step 3 — Turn the yellow numbered position indicator wheel around by removing the slotted screw. (Be sure to remove the tape covering to expose position numbers on the other side of the wheel.)

Step 4 — Replace the slotted screw.



Step 5 — Place pinion, handwheel and indicator on desired side of the drive's housing (from where the three plastic plugs were removed), and secure with the two socket-head capscrews removed previously.



Step 6 — Relocate the plastic plugs to the holes where the handwheel was originally mounted.

Lubricate the motor slide and rack (both sides) with **one** (1) stroke with a grease gun through the fittings provided in the housing. **IMPORTANT: Do not over lubricate the motor slide.** Under normal conditions, maintenance of the motor slide and rack should only be required one time per year.

Electric Remote Control (ERC) Installation

The Electric Remote Control consists of a small gearmotor mounted on the ComTrac drive in place of the manual handwheel control.

Procedure

Attaching the ERC is accomplished by simply removing the two (2) socket-head capscrews that secure the handwheel and indicator assembly to the drive's housing.

Replace the handwheel/indicator assembly with the ERC and secure it to the housing with the same two screws.

Lubricate the motor slide and rack (both sides) with one (1) stroke with a grease gun through fittings in the housing.

The ERC is operated by pushbutton or other form of contact (furnished by customer). A mechanical clutch is contained within the gearmotor which indicates the end position of travel, in either direction, by making a clicking noise. Also, the ERC can be operated while the drive is stationary.

Power required for the ERC is 230 volt, 3 phase, 60 hertz, or 115 volt, single phase, 60 hertz.

The wiring diagram for the ERC is inside the motor's conduit box.

The ERC motor and drive should be protected from excessive dust, flying chips, and oil splashes.

ComTrac® Adjustable Speed Drives

Maintenance and Lubrication Instructions



In order to obtain long life and trouble-free operation from your ComTrac® drive, it is essential that proper installation and operating procedures be followed.

The torque required by the application must not exceed the reducer torque capacity shown on the nameplate. For safety purposes a safety coupling should be installed between the reducer and the driven load. Otherwise, overload may cause damage to the interior parts of the reducer which may result in breaking the reducer housing. As a result, persons could be injured by flying parts or splashing hot gear oil.

This catalog includes basic directions for mounting and start-up of the ComTrac® drive, as well as lubrication information.

Failure to follow these instructions will void the drive's warranty.

If you have questions about the installation, operation or maintenance of your ComTrac® drive, please contact your local STÖBER distributor for assistance.

WARNING:

Safety is the most important consideration when operating any type of drive. Through proper application, safe handling methods, and wearing appropriate clothing, you can prevent accidents and injury to yourself and fellow workers.

The shafts of ComTrac® drives rotate at very high speeds and can cut off or severely injure hands, fingers, and arms. Use appropriate guards for shafts and other rotating parts at all times. Follow all directions in the service instruction manual. Obey all federal, state and local safety regulations when operating the drive.



- Always be sure electrical power is off while making electrical connections and during installation and maintenance of the unit.
- Keep clothing, hands, and tools away from ventilation openings on motors and from all rotating parts during operation.
- Lift drive with a double rope sling or other proper lifting equipment of adequate strength. Make sure load is secured and balanced to prevent shifting when unit is being moved. Lifting heavy drives by hand may be dangerous and should be avoided.
- The intended use of lifting lugs is to handle the weight of the unit only. Never use a lifting lug to lift attached assemblies.
- Never operate drive at speeds higher than those shown on the nameplate, or personal injury may result. Contact STÖBER Drives Inc., if there is any change of operating conditions from those for which the unit was originally sold (as stamped on the nameplate). Failure to comply could result in personal injury and or machinery damage.
- Always follow good safety practices at all times.

Each drive is tested before delivery. Before installation, however, it is advisable to examine the unit for possible damage which might have occurred during transit. If damage is discovered, it should be immediately reported to the transport agent.

If installation is delayed after receipt of the MGS speed reducer, the drive should be stored in a clean, dry place until put into service. Long term storage requires special procedures. If not kept in a heated, dry area, consult STÖBER Drives, Inc. for storage instructions.

NOTE: If it is necessary to clean drive shafts, take care to protect the oil seals.

IMPORTANT: Do not use any device to hammer the unit onto the output shaft during installation since the bearing races could be damaged.

Maintenance and Lubrication

WARNING: Before beginning any work on the ComTrac drive system, disconnect the power source (lock-out the motor starter, and unload breakers, backstops, etc.). Failure to do so may cause serious personal injury and/or machinery damage.

Series 0N and 0F

These units require lubricant only in the cam and bearing chamber and are shipped with the lubricant in them. There is a sufficient quantity of lubricant to allow mounting the non-geared ComTrac Drive in any position.

Table No. 1

Series "0" – Bearing and Cam Chamber Oil Quantity

ComTrac Size	fluid ozs.	ComTrac Size	fluid ozs.
TD27-0	1.5	TD57-0	4.4
TD37-0	1.7	TD67-0	5.4
TD47-0	1.9	TD76-0	6.1

For normal indoor installations the handwheel or ERC control pinion and motor slide rack should be lubricated through the grease fitting every six months using NLGI No. 2 grease. One stroke of a grease gun is sufficient. When the drive is operating under wet conditions, increase the frequency of lubrication to once a month.

Under normal operating conditions the synthetic oil in the cam and bearing chamber does not need to be replaced. If for any reason some quantity of lubricant is lost, remove the rest of the lubricant from the cam and bearing chamber and replace it with the type and quantity of oil listed in the lubrication table shown.

Table No. 2 Bearing and Cam Oil Manufacturers

Lubricant Manufacturer	AGMA Lubricant (No. 5EP)
Darmex	9140
Exxon	Spartan 220
Mobil *	Mobilgear 630
Gulf	HD220
Keystone	KSL-366
Lubriplate	APG90

* Mobile SHC626 is used for the initial fill. If refill is necessary, any of the above products may be used.

For installations in the food, dairy, beverage and baking industries, where special lubricants are required, a suitable grease of the user's preference should be used.

When a ComTrac Drive with C-face output (Series 0F) is attached to a speed reducer, follow the manufacturer's lubrication instructions for the reducer mounting before start-up.



"C" Series – Concentric Helical MGS® Adjustable Speed Drives

Performance Specifications:

- Horsepower ratings — from 1/2 to 10
- Output speeds — available from 1139 to 1.2 RPM
- Speed range — 5:1 to 7:1
- Output torques — up to 59,782 in.lbs.
- NEMA frames — from 56C to 215TC

STOBER can offer a wider variety of sizes, ratios, and mounting positions than ever before by utilizing MGS Reducers and ComTrac Adjustable Speed Drives.

These versatile gear drives offer you performance, durability, and economy for a wide range of variable speed applications. High efficiency helical gearing keeps motor size to a minimum while conserving energy.

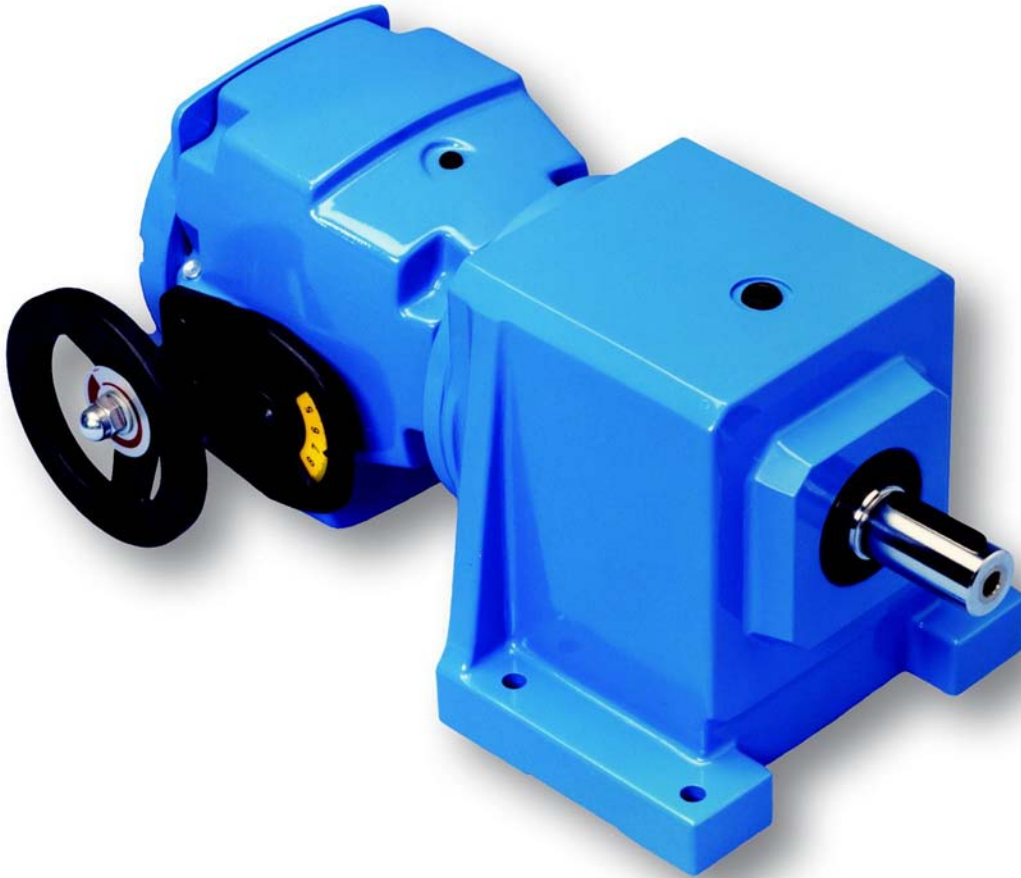

Table No. 1 "C" Series – Output Shaft Diameter

Base Module	Inches		Metric ⁽¹⁾
	Standard	Stainless Steel	
C002	.750	.750	20
C102/C103	1.000	1.000	25
C202/C203	1.250	1.250	30
C302/C303	1.250	1.250	40
C402/C403	1.625	1.625	40
C512/C513	1.625	1.625	40
C612/C613	2.125	2.125	50
C712/C713	2.375	—	60
C812/C813	2.875	—	70
C912/C913	3.625	—	90

⁽¹⁾ Contact STOBER Drives for availability.



"C" Series – MGS Adjustable Speed Drive Selection Data



Speed Range Output RPM ⁽¹⁾		Part Number	Maximum		Transition ⁽²⁾		Minimum	
			RPM	Torque in.lbs.	RPM	Torque in.lbs.	RPM	Torque in.lbs.
Max.	Min.							

.50 HP, 1750 RPM Motor

1,139	163	C002_0020	TD270K 050-050	1,139	22	163	129	163	129
1,045	149	C102_0022	TD270K 050-050	1,045	25	149	140	149	140
822	117	C002_0028	TD270K 050-050	822	31	117	178	117	178
742	106	C002_0031	TD270K 050-050	742	35	106	198	106	198
686	98	C002_0033	TD270K 050-050	686	37	98	214	98	214
593	85	C002_0038	TD270K 050-050	593	43	85	247	85	247
586	84	C102_0039	TD270K 050-050	586	44	84	250	84	250
548	78	C002_0041	TD270K 050-050	548	47	78	267	78	267
543	78	C102_0042	TD270K 050-050	543	47	78	270	78	270
486	69	C002_0047	TD270K 050-050	486	53	69	302	69	302
453	65	C102_0050	TD270K 050-050	453	57	65	324	65	324
449	64	C002_0051	TD270K 050-050	449	57	64	326	64	326
391	56	C002_0058	TD270K 050-050	391	66	56	375	56	375
387	55	C102_0059	TD270K 050-050	387	66	55	379	55	379
361	52	C002_0063	TD270K 050-050	361	71	52	406	52	406
295	42	C002_0077	TD270K 050-050	295	87	42	497	42	497
292	42	C102_0078	TD270K 050-050	292	88	42	502	42	502
276	39	C002_0082	TD270K 050-050	276	93	39	531	39	531
275	39	C102_0083	TD270K 050-050	275	93	39	532	39	532
247	35	C002_0092	TD270K 050-050	247	104	42	531	35	531
244	35	C102_0093	TD270K 050-050	244	105	35	601	35	601
221	32	C002_0105	TD270K 050-050	221	116	44	531	32	531
197	28	C002_0115	TD270K 050-050	197	130	45	531	28	531
181	26	C002_0125	TD270K 050-050	181	141	46	531	26	531
162	23	C002_0140	TD270K 050-050	162	159	48	531	23	531
145	21	C002_0155	TD270K 050-050	145	176	49	531	21	531
130	19	C002_0175	TD270K 050-050	130	197	49	531	19	531
110	16	C002_0210	TD270K 050-050	110	233	50	531	16	531
98	14	C002_0230	TD270K 050-050	98	261	51	531	14	531
97	14	C102_0240	TD270K 050-050	97	265	23	1,063	14	1,063
91	13	C002_0250	TD270K 050-050	91	281	51	531	13	531
91	13	C102_0250	TD270K 050-050	91	283	23	1,063	13	1,063
81	12	C002_0280	TD270K 050-050	81	315	51	531	12	531
80	11	C102_0280	TD270K 050-050	80	319	24	1,063	11	1,063
73	10	C002_0310	TD270K 050-050	73	352	50	531	10	531
73	10	C102_0310	TD270K 050-050	73	350	24	1,063	10	1,063
65	9.3	C002_0350	TD270K 050-050	65	394	50	531	9.3	531

¹⁾ Speed tolerance at rated load is ±3%. At less than rated load, minimum speed may increase 5%.

²⁾ The ComTrac drive operates at constant horsepower above transition values and at constant torque below transition values. Note shaded area. Engineering advances may cause slight changes to the information shown.

Housing Styles

N — Foot Mounted **F** — Round Flange **Q** — Square Flange **G** — Tapped Holes

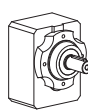
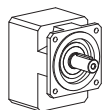
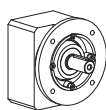
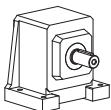

See page 78 for mounting positions.
Housing Style Q is available on special order.

Output Shaft Diameter (inches)

See Page 21 for other options.

Base Module	Dia.	Base Module	Dia.
C002	.7500	C512/C513	1.6250
C102/C103	1.0000	C612/C613	2.1250
C202/C203	1.2500	C712/C713	2.3750
C302/C303	1.2500	C812/C813	2.8750
C402/C403	1.6250	C912/C913	3.6250



"C" Series – MGS Adjustable Speed Drive Selection Data



Speed Range		Part Number	Maximum		Transition ⁽²⁾		Minimum			
Output RPM ⁽¹⁾			RPM	Torque in. lbs.	RPM	Torque in. lbs.	RPM	Torque in. lbs.		
Max.	Min.									
.50 HP, 1750 RPM Motor										
Continued										
65	9.3	C102_0350	TD270K	050-050	65	395	25	1,063	9.3	1,063
56	8.0	C202_0410	TD270K	050-050	56	460	14	1,772	8.0	1,772
55	7.8	C102_0420	TD270K	050-050	55	468	25	1,063	7.8	1,063
48	6.9	C102_0470	TD270K	050-050	48	528	25	1,063	6.9	1,063
46	6.6	C202_0490	TD270K	050-050	46	554	14	1,772	6.6	1,772
46	6.5	C302_0500	TD270K	050-050	46	560	7	3,100	6.5	3,100
40	5.8	C202_0560	TD270K	050-050	40	635	15	1,772	5.8	1,772
37	5.2	C302_0620	TD270K	050-050	37	697	8	2,932	5.2	2,932
36	5.2	C402_0630	TD270K	050-050	36	704	5	4,029	5.2	4,029
33	4.7	C302_0700	TD270K	050-050	33	786	8	3,100	4.7	3,100
30	4.3	C613_0760	TD270K	050-050	30	841	4	4,815	4.3	4,815
29	4.1	C203_0800	TD270K	050-050	29	883	15	1,772	4.1	1,772
28	4.0	C403_0810	TD270K	050-050	28	896	4	4,872	4.0	4,872
26	3.7	C613_0880	TD270K	050-050	26	972	4	5,566	3.7	5,566
25	3.6	C203_0910	TD270K	050-050	25	1,012	15	1,772	3.6	1,772
25	3.6	C303_0910	TD270K	050-050	25	1,007	8	3,100	3.6	3,100
25	3.6	C403_0900	TD270K	050-050	25	1,002	5	4,872	3.6	4,872
21	3.0	C203_1090	TD270K	050-050	21	1,211	15	1,772	3.0	1,772
21	3.0	C303_1080	TD270K	050-050	21	1,200	8	3,100	3.0	3,100
21	3.0	C503_1090	TD270K	050-050	21	1,205	3	6,900	3.0	6,900
21	3.1	C613_1060	TD270K	050-050	21	1,176	3	6,736	3.1	6,736
17	2.4	C203_1360	TD270K	050-050	17	1,509	15	1,772	2.4	1,772
17	2.4	C303_1350	TD270K	050-050	17	1,502	9	3,100	2.4	3,100
13	1.8	C303_1800	TD270K	050-050	13	2,002	9	3,100	1.8	3,100
13	1.8	C403_1800	TD270K	050-050	13	2,002	5	4,872	1.8	4,872
13	1.8	C503_1810	TD270K	050-050	13	2,004	3	7,086	1.8	7,086
13	1.9	C613_1750	TD270K	050-050	13	1,944	2	11,133	1.9	11,133
11	1.5	C503_2160	TD270K	050-050	11	2,395	4	7,086	1.5	7,086
11	1.5	C613_2130	TD270K	050-050	11	2,364	2	11,515	2.5	11,515
10	1.5	C303_2170	TD270K	050-050	10	2,408	8	3,100	1.5	3,100
10	1.5	C403_2170	TD270K	050-050	10	2,406	5	4,872	1.5	4,872
9	1.2	C613_2660	TD270K	050-050	9	2,955	2	11,515	1.2	11,515
8	1.2	C403_2700	TD270K	050-050	8	2,997	5	4,872	1.2	4,872
8	1.2	C503_2710	TD270K	050-050	8	3,001	4	7,086	1.2	7,086

Part No. Explanation

Selection Procedure:

- Determine the MGS/ComTrac combination according to the Input HP of the application and the Output RPM nearest the required **maximum** speed.
- Verify that the output torque will sufficiently meet the application requirements.
- Complete the Part No. per the example by adding the Housing Style letter ("N", "F", "Q" or "G") as required.

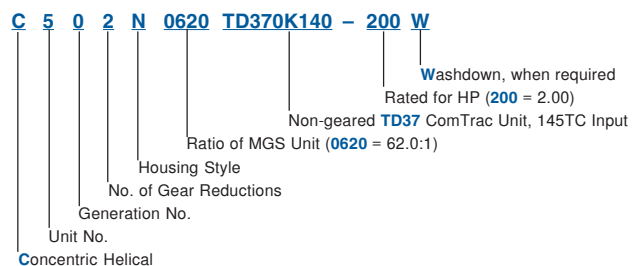



"C" Series – MGS Adjustable Speed Drive Selection Data



Speed Range		Part Number		Maximum		Transition ⁽²⁾		Minimum	
Output RPM ⁽¹⁾				RPM	Torque in.lbs.	RPM	Torque in.lbs.	RPM	Torque in.lbs.
Max.	Min.								
.75 HP, 1750 RPM Motor									
1,139	163	C002_0020	TD270K 050-075	1,139	33	282	129	163	129
1,045	149	C102_0022	TD270K 050-075	1,045	36	259	140	149	140
822	117	C002_0028	TD270K 050-075	822	46	204	178	117	178
742	106	C002_0031	TD270K 050-075	742	51	184	198	106	198
686	98	C002_0033	TD270K 050-075	686	55	170	214	98	214
593	85	C002_0038	TD270K 050-075	593	64	147	247	85	247
586	84	C102_0039	TD270K 050-075	586	65	145	250	84	250
548	78	C002_0041	TD270K 050-075	548	69	136	267	78	267
543	78	C102_0042	TD270K 050-075	543	70	135	270	78	270
486	69	C002_0047	TD270K 050-075	486	78	120	302	69	302
453	65	C102_0050	TD270K 050-075	453	84	112	324	65	324
449	64	C002_0051	TD270K 050-075	449	85	111	326	64	326
391	56	C002_0058	TD270K 050-075	391	97	97	375	56	375
387	55	C102_0059	TD270K 050-075	387	98	96	379	55	379
361	52	C002_0063	TD270K 050-075	361	105	89	406	52	406
295	42	C002_0077	TD270K 050-075	295	129	73	497	42	497
292	42	C102_0078	TD270K 050-075	292	130	72	502	42	502
276	39	C002_0082	TD270K 050-075	276	138	68	531	39	531
275	39	C102_0083	TD270K 050-075	275	138	68	532	39	532
247	35	C002_0092	TD270K 050-075	247	154	70	531	35	531
244	35	C102_0093	TD270K 050-075	244	156	60	601	35	601
221	32	C002_0105	TD270K 050-075	221	172	72	531	32	531
197	28	C002_0115	TD270K 050-075	197	193	73	531	28	531
181	26	C002_0125	TD270K 050-075	181	210	74	531	26	531
162	23	C002_0140	TD270K 050-075	162	235	75	531	23	531
145	21	C002_0155	TD270K 050-075	145	261	75	531	21	531
130	19	C002_0175	TD270K 050-075	130	293	75	531	19	531
128	18	C102_0175	TD270K 050-075	128	296	35	1,063	18	1,063
110	16	C002_0210	TD270K 050-075	110	346	75	531	16	531
109	16	C102_0210	TD270K 050-075	109	348	36	1,063	16	1,063
98	14	C002_0230	TD270K 050-075	98	388	74	531	14	531
97	14	C102_0240	TD270K 050-075	97	393	37	1,063	14	1,063
91	13	C002_0250	TD270K 050-075	91	417	74	531	13	531
91	13	C102_0250	TD270K 050-075	91	420	37	1,063	13	1,063
81	12	C002_0280	TD270K 050-075	81	468	73	531	12	531
80	11	C102_0280	TD270K 050-075	80	474	37	1,063	11	1,063
73	10	C002_0310	TD270K 050-075	73	522	72	531	10	531
73	10	C102_0310	TD270K 050-075	73	519	37	1,063	10	1,063

¹⁾ Speed tolerance at rated load is $\pm 3\%$. At less than rated load, minimum speed may increase 5%.

²⁾ The ComTrac drive operates at constant horsepower above transition values and at constant torque below transition values. Note shaded area. Engineering advances may cause slight changes to the information shown.

Housing Styles

N — Foot Mounted **F** — Round Flange **Q** — Square Flange **G** — Tapped Holes

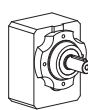
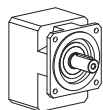
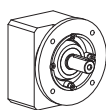
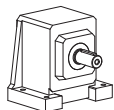

See page 78 for mounting positions.
Housing Style Q is available on special order.

Output Shaft Diameter (inches)

See Page 21 for other options.

Base Module	Dia.	Base Module	Dia.
C002	.7500	C512/C513	1.6250
C102/C103	1.0000	C612/C613	2.1250
C202/C203	1.2500	C712/C713	2.3750
C302/C303	1.2500	C812/C813	2.8750
C402/C403	1.6250	C912/C913	3.6250



"C" Series – MGS Adjustable Speed Drive Selection Data



Speed Range		Part Number	Maximum		Transition ⁽²⁾		Minimum			
Output RPM ⁽¹⁾			RPM	Torque in. lbs.	RPM	Torque in. lbs.	RPM	Torque in. lbs.		
Max.	Min.									
.75 HP, 1750 RPM Motor										
Continued										
65	9.3	C102_0350	TD270K	050-075	65	586	38	1,063	9.3	1,063
65	9.2	C202_0350	TD270K	050-075	65	588	22	1,772	9.2	1,772
56	8.0	C202_0410	TD270K	050-075	56	683	22	1,772	8.0	1,772
55	7.8	C102_0420	TD270K	050-075	55	695	38	1,063	7.8	1,063
48	6.9	C102_0470	TD270K	050-075	48	784	37	1,063	6.9	1,063
49	6.9	C202_0470	TD270K	050-075	49	783	22	1,772	6.9	1,772
46	6.6	C202_0490	TD270K	050-075	46	823	22	1,772	6.6	1,772
46	6.5	C302_0500	TD270K	050-075	46	832	12	3,100	6.5	3,100
40	5.8	C202_0560	TD270K	050-075	40	943	23	1,772	5.8	1,772
41	5.8	C302_0560	TD270K	050-075	41	938	12	3,100	5.8	3,100
37	5.2	C302_0620	TD270K	050-075	37	1,035	13	2,932	5.2	2,932
36	5.2	C402_0630	TD270K	050-075	36	1,045	9	4,029	5.2	4,029
33	4.7	C302_0700	TD270K	050-075	33	1,168	13	3,100	4.7	3,100
30	4.3	C613_0760	TD270K	050-075	30	1,249	7	4,815	4.3	4,815
29	4.1	C203_0800	TD270K	050-075	29	1,311	22	1,772	4.1	1,772
28	4.0	C303_0800	TD270K	050-075	28	1,325	13	3,100	4.0	3,100
28	4.0	C403_0810	TD270K	050-075	28	1,331	7	4,872	4.0	4,872
26	3.7	C613_0880	TD270K	050-075	26	1,444	6	5,566	3.7	5,566
25	3.6	C203_0910	TD270K	050-075	25	1,503	22	1,772	3.6	1,772
25	3.6	C303_0910	TD270K	050-075	25	1,495	13	3,100	3.6	3,100
25	3.6	C403_0900	TD270K	050-075	25	1,488	8	4,872	3.6	4,872
21	3.0	C303_1080	TD270K	050-075	21	1,783	13	3,100	3.0	3,100
21	3.0	C403_1080	TD270K	050-075	21	1,774	8	4,872	3.0	4,872
21	3.0	C503_1090	TD270K	050-075	21	1,790	5	6,900	3.0	6,900
21	3.1	C613_1060	TD270K	050-075	21	1,747	5	6,736	3.1	6,736
17	2.4	C303_1350	TD270K	050-075	17	2,231	13	3,100	2.4	3,100
17	2.4	C403_1350	TD270K	050-075	17	2,218	8	4,872	2.4	4,872
13	1.8	C303_1800	TD270K	050-075	13	2,973	12	3,100	1.8	3,100
13	1.8	C403_1800	TD270K	050-075	13	2,973	8	4,872	1.8	4,872
13	1.8	C503_1810	TD270K	050-075	13	2,976	5	7,086	1.8	7,086
13	1.9	C613_1750	TD270K	050-075	13	2,888	3	11,133	1.9	11,133
11	1.5	C503_2160	TD270K	050-075	11	3,557	6	7,086	1.5	7,086
11	1.8	C613_2130	TD270K	050-075	11	3,511	3	11,515	1.5	11,515
10	1.5	C403_2170	TD270K	050-075	10	3,574	8	4,872	1.5	4,872
9	1.2	C613_2660	TD270K	050-075	9	4,388	3	11,515	1.2	11,515
8	1.2	C403_2700	TD270K	050-075	8	4,451	8	4,872	1.2	4,872
8	1.2	C503_2710	TD270K	050-075	8	4,457	6	7,086	1.2	7,086

Part No. Explanation

Selection Procedure:

- Determine the MGS/ComTrac combination according to the Input HP of the application and the Output RPM nearest the required **maximum** speed.
- Verify that the output torque will sufficiently meet the application requirements.
- Complete the Part No. per the example by adding the Housing Style letter ("N", "F", "Q" or "G") as required.

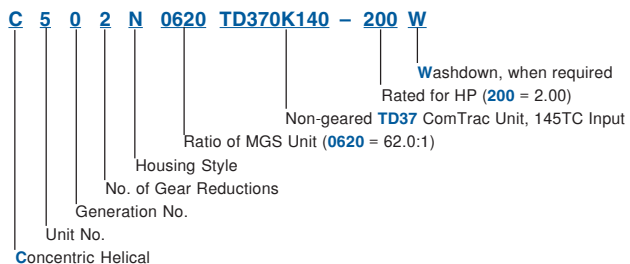



"C" Series – MGS Adjustable Speed Drive Selection Data



Speed Range		Part Number		Maximum		Transition ⁽²⁾		Minimum		
Output RPM ⁽¹⁾				RPM	Torque in.lbs.	RPM	Torque in.lbs.	RPM	Torque in.lbs.	
Max.	Min.									
1.0 HP, 1750 RPM Motor										
1,139	163	C002_0020	TD270K 140-100	1,139	46	411	129	163	129	
1,045	149	C102_0022	TD270K 140-100	1,045	50	377	140	149	140	
822	117	C002_0028	TD270K 140-100	822	63	296	178	117	178	
742	106	C002_0031	TD270K 140-100	742	70	267	198	106	198	
686	98	C002_0033	TD270K 140-100	686	76	247	214	98	214	
593	85	C002_0038	TD270K 140-100	593	87	214	247	85	247	
586	84	C102_0039	TD270K 140-100	586	88	211	250	84	250	
548	78	C002_0041	TD270K 140-100	548	95	198	267	78	267	
543	78	C102_0042	TD270K 140-100	543	95	196	270	78	270	
486	69	C002_0047	TD270K 140-100	486	107	175	302	69	302	
453	65	C102_0050	TD270K 140-100	453	115	163	324	65	324	
449	64	C002_0051	TD270K 140-100	449	115	162	326	64	326	
391	56	C002_0058	TD270K 140-100	391	133	141	375	56	375	
387	55	C102_0059	TD270K 140-100	387	134	140	379	55	379	
361	52	C002_0063	TD270K 140-100	361	144	130	406	52	406	
295	42	C002_0077	TD270K 140-100	295	176	106	497	42	497	
292	42	C102_0078	TD270K 140-100	292	178	105	502	42	502	
276	39	C002_0082	TD270K 140-100	276	188	100	531	39	531	
275	39	C102_0083	TD270K 140-100	275	188	99	532	39	532	
247	35	C002_0092	TD270K 140-100	247	210	101	531	35	531	
244	35	C102_0093	TD270K 140-100	244	213	88	601	35	601	
221	32	C002_0105	TD270K 140-100	221	235	102	531	32	531	
197	28	C002_0115	TD270K 140-100	197	263	102	531	28	531	
181	26	C002_0125	TD270K 140-100	181	286	103	531	26	531	
183	26	C102_0125	TD270K 140-100	183	284	66	803	26	803	
162	23	C002_0140	TD270K 140-100	162	321	103	531	23	531	
162	23	C102_0140	TD270K 140-100	162	320	58	906	23	906	
145	21	C002_0155	TD270K 140-100	145	356	102	531	21	531	
145	21	C102_0155	TD270K 140-100	145	358	52	1,012	21	1,012	
130	19	C002_0175	TD270K 140-100	130	399	101	531	19	531	
128	18	C102_0175	TD270K 140-100	128	404	50	1,063	18	1,063	
110	16	C002_0210	TD270K 140-100	110	472	99	531	16	531	
109	16	C102_0210	TD270K 140-100	109	475	51	1,063	16	1,063	
98	14	C002_0230	TD270K 140-100	98	529	98	531	14	531	
97	14	C102_0240	TD270K 140-100	97	536	51	1,063	14	1,063	
96	14	C202_0240	TD270K 140-100	96	538	35	1,520	14	1,520	
91	13	C102_0250	TD270K 140-100	91	573	51	1,063	13	1,063	
92	13	C202_0250	TD270K 140-100	92	562	33	1,588	13	1,588	
80	11	C102_0280	TD270K 140-100	80	646	51	1,063	11	1,063	
81	12	C202_0280	TD270K 140-100	81	644	30	1,772	12	1,772	

¹⁾ Speed tolerance at rated load is ±3%. At less than rated load, minimum speed may increase 5%.

²⁾ The ComTrac drive operates at constant horsepower above transition values and at constant torque below transition values. Note shaded area. Engineering advances may cause slight changes to the information shown.

Housing Styles

N — Foot Mounted F — Round Flange Q — Square Flange G — Tapped Holes

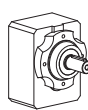
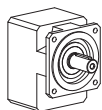
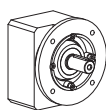
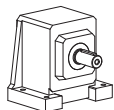

See page 78 for mounting positions.

Housing Style Q is available on special order.

Output Shaft Diameter (inches)

See Page 21 for other options.

Base Module	Dia.	Base Module	Dia.
C002	.7500	C512/C513	1.6250
C102/C103	1.0000	C612/C613	2.1250
C202/C203	1.2500	C712/C713	2.3750
C302/C303	1.2500	C812/C813	2.8750
C402/C403	1.6250	C912/C913	3.6250



"C" Series – MGS Adjustable Speed Drive Selection Data



Speed Range Output RPM ⁽¹⁾		Part Number	Maximum		Transition ⁽²⁾		Minimum	
			RPM	Torque in. lbs.	RPM	Torque in. lbs.	RPM	Torque in. lbs.
Max.	Min.							

1.0 HP, 1750 RPM Motor

Continued

73	10	C102_0310	TD270K 140-100	73	708	51	1,063	10	1,063
74	11	C202_0310	TD270K 140-100	74	699	30	1,772	11	1,772
65	9.3	C102_0350	TD270K 140-100	65	799	51	1,063	9.3	1,063
65	9.2	C202_0350	TD270K 140-100	65	802	31	1,772	9.2	1,772
56	8.0	C202_0410	TD270K 140-100	56	931	31	1,772	8.0	1,772
55	7.9	C302_0410	TD270K 140-100	55	942	20	2,665	7.9	2,665
55	7.8	C102_0420	TD270K 140-100	55	947	50	1,063	7.8	1,063
49	6.9	C202_0470	TD270K 140-100	49	1,067	31	1,772	6.9	1,772
49	7.0	C302_0470	TD270K 140-100	49	1,063	18	3,007	7.0	3,007
46	6.6	C202_0490	TD270K 140-100	46	1,122	31	1,772	6.6	1,772
46	6.5	C302_0500	TD270K 140-100	46	1,134	17	3,100	6.5	3,100
40	5.8	C202_0560	TD270K 140-100	40	1,286	30	1,772	5.8	1,772
41	5.8	C302_0560	TD270K 140-100	41	1,279	17	3,100	5.8	3,100
37	5.2	C302_0620	TD270K 140-100	37	1,411	19	2,932	5.2	2,932
36	5.2	C402_0630	TD270K 140-100	36	1,425	13	4,029	5.2	4,029
33	4.7	C302_0700	TD270K 140-100	33	1,592	18	3,100	4.7	3,100
33	4.7	C402_0700	TD270K 140-100	33	1,592	12	4,503	4.7	4,503
30	4.3	C613_0760	TD270K 140-100	30	1,703	11	4,815	4.3	4,815
28	4.0	C303_0800	TD270K 140-100	28	1,806	17	3,100	4.0	3,100
28	4.0	C403_0810	TD270K 140-100	28	1,815	11	4,872	4.0	4,872
26	3.7	C613_0880	TD270K 140-100	26	1,968	9	5,566	3.7	5,566
25	3.6	C303_0910	TD270K 140-100	25	2,038	17	3,100	3.6	3,100
25	3.6	C403_0900	TD270K 140-100	25	2,029	11	4,872	3.6	4,872
21	3.0	C303_1080	TD270K 140-100	21	2,430	17	3,100	3.0	3,100
21	3.0	C403_1080	TD270K 140-100	21	2,419	11	4,872	3.0	4,872
21	3.0	C503_1090	TD270K 140-100	21	2,440	8	6,900	3.0	6,900
21	3.1	C613_1060	TD270K 140-100	21	2,382	8	6,736	3.1	6,736
17	2.4	C303_1350	TD270K 140-100	17	3,042	17	3,100	2.4	3,100
17	2.4	C403_1350	TD270K 140-100	17	3,024	11	4,872	2.4	4,872
17	2.4	C503_1350	TD270K 140-100	17	3,040	7	7,086	2.4	7,086
13	1.8	C403_1800	TD270K 140-100	13	4,053	11	4,872	1.8	4,872
13	1.8	C503_1810	TD270K 140-100	13	4,057	8	7,086	1.8	7,086
13	1.9	C613_1750	TD270K 140-100	13	3,937	5	11,133	1.9	11,133
11	1.5	C503_2160	TD270K 140-100	11	4,849	8	7,086	1.5	7,086
11	1.5	C613_2130	TD270K 140-100	11	4,786	5	11,515	1.5	11,515
10	1.5	C403_2170	TD270K 140-100	10	4,872	10	4,872	1.5	4,872
9	1.2	C613_2660	TD270K 140-100	9	5,983	5	11,515	1.2	11,515
8	1.2	C503_2710	TD270K 140-100	8	6,076	7	7,086	1.2	7,086

Part No. Explanation

Selection Procedure:

- Determine the MGS/ComTrac combination according to the Input HP of the application and the Output RPM nearest the required **maximum** speed.
- Verify that the output torque will sufficiently meet the application requirements.
- Complete the Part No. per the example by adding the Housing Style letter ("N", "F", "Q" or "G") as required.

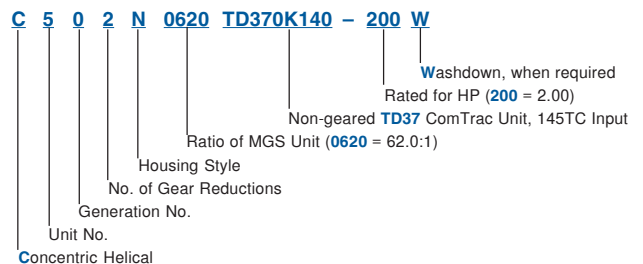



"C" Series – MGS Adjustable Speed Drive Selection Data



Speed Range		Part Number	Maximum		Transition ⁽²⁾		Minimum	
Output RPM ⁽¹⁾			RPM	Torque in.lbs.	RPM	Torque in.lbs.	RPM	Torque in.lbs.
Max.	Min.							

1.5 HP, 1750 RPM Motor

1,095	219	C002_0020	TD370K 140-150	1,095	70	419	189	219	189
1,005	201	C102_0022	TD370K 140-150	1,005	77	384	206	201	206
914	183	C102_0024	TD370K 140-150	914	84	349	226	183	226
847	169	C102_0026	TD370K 140-150	847	91	324	244	169	244
790	158	C002_0028	TD370K 140-150	790	97	302	262	158	262
713	143	C002_0031	TD370K 140-150	713	108	273	290	143	290
659	132	C002_0033	TD370K 140-150	659	117	252	314	132	314
649	130	C202_0034	TD370K 140-150	649	119	248	319	130	319
570	114	C002_0038	TD370K 140-150	570	135	218	362	114	362
563	113	C102_0039	TD370K 140-150	563	137	215	367	113	367
527	105	C002_0041	TD370K 140-150	527	146	202	392	105	392
522	104	C102_0042	TD370K 140-150	522	147	200	396	104	396
467	93	C002_0047	TD370K 140-150	467	165	179	442	93	442
435	87	C102_0050	TD370K 140-150	435	177	166	475	87	475
432	86	C002_0051	TD370K 140-150	432	178	165	479	86	479
376	75	C002_0058	TD370K 140-150	376	205	158	504	75	504
378	76	C202_0058	TD370K 140-150	378	204	144	547	76	547
372	74	C102_0059	TD370K 140-150	372	207	142	555	74	555
347	69	C002_0063	TD370K 140-150	347	222	159	503	69	503
345	69	C102_0063	TD370K 140-150	345	223	132	599	69	599
281	56	C102_0078	TD370K 140-150	281	274	107	737	56	737
266	53	C002_0082	TD370K 140-150	266	290	153	531	53	531
267	53	C202_0082	TD370K 140-150	267	288	102	774	53	774
265	53	C102_0083	TD370K 140-150	265	291	101	781	53	781
237	47	C002_0092	TD370K 140-150	237	325	152	531	47	531
235	47	C102_0093	TD370K 140-150	235	328	90	881	47	881
233	47	C202_0094	TD370K 140-150	233	330	89	887	47	887
212	42	C002_0105	TD370K 140-150	212	362	151	531	42	531
211	42	C102_0105	TD370K 140-150	211	365	81	981	42	981
190	38	C002_0115	TD370K 140-150	190	406	150	531	38	531
187	37	C102_0115	TD370K 140-150	187	412	75	1,063	37	1,063
186	37	C202_0120	TD370K 140-150	186	414	71	1,111	37	1,111
174	35	C002_0125	TD370K 140-150	174	442	148	531	35	531
176	35	C102_0125	TD370K 140-150	176	438	75	1,063	35	1,063
155	31	C002_0140	TD370K 140-150	155	495	146	531	31	531
156	31	C102_0140	TD370K 140-150	156	494	76	1,063	31	1,063
139	28	C102_0155	TD370K 140-150	139	553	76	1,063	28	1,063
143	29	C202_0155	TD370K 140-150	143	538	55	1,444	29	1,444
123	25	C102_0175	TD370K 140-150	123	624	76	1,063	25	1,063
125	25	C202_0175	TD370K 140-150	125	616	48	1,656	25	1,656
105	21	C102_0210	TD370K 140-150	105	733	76	1,063	21	1,063
106	21	C202_0210	TD370K 140-150	106	724	45	1,772	21	1,772
93	19	C302_0230	TD370K 140-150	93	826	36	2,218	19	2,218
93	19	C102_0240	TD370K 140-150	93	828	75	1,063	19	1,063

¹⁾ Speed tolerance at rated load is ±3%. At less than rated load, minimum speed may increase 5%.

²⁾ The ComTrac drive operates at constant horsepower above transition values and at constant torque below transition values. Note shaded area. Engineering advances may cause slight changes to the information shown.

Housing Styles

N — Foot Mounted **F** — Round Flange **Q** — Square Flange **G** — Tapped Holes

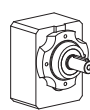
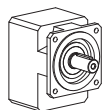
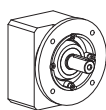
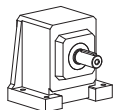

See page 78 for mounting positions.
Housing Style Q is available on special order.

Output Shaft Diameter (inches)

See Page 21 for other options.

Base Module	Dia.	Base Module	Dia.
C002	.7500	C512/C513	1.6250
C102/C103	1.0000	C612/C613	2.1250
C202/C203	1.2500	C712/C713	2.3750
C302/C303	1.2500	C812/C813	2.8750
C402/C403	1.6250	C912/C913	3.6250



"C" Series – MGS Adjustable Speed Drive Selection Data



Speed Range Output RPM ⁽¹⁾		Part Number	Maximum		Transition ⁽²⁾		Minimum	
			RPM	Torque in. lbs.	RPM	Torque in. lbs.	RPM	Torque in. lbs.
Max.	Min.							

1.5 HP, 1750 RPM Motor

Continued

93	19	C202_0240	TD370K 140-150	93	830	45	1,772	19	1,772
87	17	C102_0250	TD370K 140-150	87	884	74	1,063	17	1,063
89	18	C202_0250	TD370K 140-150	89	867	45	1,772	18	1,772
77	15	C102_0280	TD370K 140-150	77	998	73	1,063	15	1,063
77	15	C202_0280	TD370K 140-150	77	994	46	1,772	15	1,772
78	16	C302_0280	TD370K 140-150	78	985	30	2,645	16	2,645
71	14	C202_0310	TD370K 140-150	71	1,080	46	1,772	14	1,772
70	14	C302_0310	TD370K 140-150	70	1,092	27	2,934	14	2,934
62	12	C202_0350	TD370K 140-150	62	1,238	45	1,772	12	1,772
62	12	C302_0350	TD370K 140-150	62	1,232	26	3,100	12	3,100
54	11	C202_0410	TD370K 140-150	54	1,437	45	1,772	11	1,772
53	11	C302_0410	TD370K 140-150	53	1,455	26	3,100	11	3,100
52	10	C402_0420	TD370K 140-150	52	1,469	20	3,946	10	3,946
47	9.3	C202_0470	TD370K 140-150	47	1,647	44	1,772	9.3	1,772
47	9.4	C302_0470	TD370K 140-150	47	1,642	26	3,100	9.4	3,100
47	9.4	C402_0470	TD370K 140-150	47	1,642	18	4,411	9.4	4,411
44	8.8	C302_0500	TD370K 140-150	44	1,750	26	3,100	8.8	3,100
44	8.7	C402_0500	TD370K 140-150	44	1,766	17	4,744	8.7	4,744
39	7.8	C302_0560	TD370K 140-150	39	1,975	26	3,100	7.8	3,100
39	7.8	C402_0560	TD370K 140-150	39	1,974	16	4,872	7.8	4,872
35	7.0	C402_0630	TD370K 140-150	35	2,199	18	4,440	7.0	4,440
35	7.0	C502_0620	TD370K 140-150	35	2,196	13	5,901	7.0	5,901
31	6.3	C402_0700	TD370K 140-150	31	2,458	17	4,872	6.3	4,872
31	6.3	C502_0700	TD370K 140-150	31	2,461	12	6,613	6.3	6,613
29	5.8	C613_0760	TD370K 140-150	29	2,629	11	7,062	5.8	7,062
27	5.4	C303_0800	TD370K 140-150	27	2,789	25	3,100	5.4	3,100
27	5.4	C403_0810	TD370K 140-150	27	2,802	16	4,872	5.4	4,872
27	5.4	C503_0810	TD370K 140-150	27	2,794	11	7,086	5.4	7,086
25	5.0	C613_0880	TD370K 140-150	25	3,039	10	8,164	5.0	8,164
24	4.8	C403_0900	TD370K 140-150	24	3,132	16	4,872	4.8	4,872
24	4.8	C503_0900	TD370K 140-150	24	3,132	11	7,086	4.8	7,086
21	4.1	C613_1060	TD370K 140-150	21	3,677	8	9,879	4.1	9,879
20	4.1	C403_1080	TD370K 140-150	20	3,735	16	4,872	4.1	4,872
20	4.0	C503_1090	TD370K 140-150	20	3,767	11	7,086	4.0	7,086
16	3.2	C403_1350	TD370K 140-150	16	4,668	16	4,872	3.2	4,872
16	3.2	C503_1350	TD370K 140-150	16	4,692	11	7,086	3.2	7,086
16	3.2	C613_1350	TD370K 140-150	16	4,675	7	11,515	3.2	11,515
12	2.5	C613_1750	TD370K 140-150	12	6,078	7	11,515	2.5	11,515
12	2.4	C503_1810	TD370K 140-150	12	6,263	11	7,086	2.4	7,086
10	2.1	C613_2130	TD370K 140-150	10	7,389	7	11,515	2.1	11,515
8	1.6	C613_2660	TD370K 140-150	8	9,236	7	11,515	1.6	11,515

Part No. Explanation

Selection Procedure:

- Determine the MGS/ComTrac combination according to the Input HP of the application and the Output RPM nearest the required **maximum** speed.
- Verify that the output torque will sufficiently meet the application requirements.
- Complete the Part No. per the example by adding the Housing Style letter ("N", "F", "Q" or "G") as required.

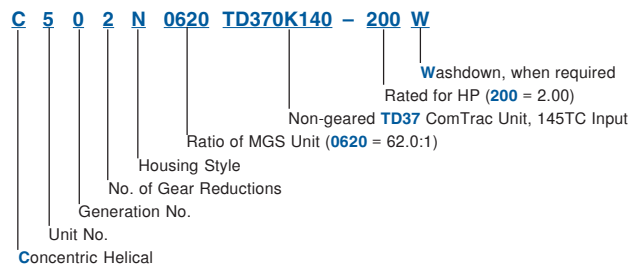



"C" Series – MGS Adjustable Speed Drive Selection Data



Speed Range Output RPM ⁽¹⁾		Part Number	Maximum		Transition ⁽²⁾		Minimum	
			RPM	Torque in.lbs.	RPM	Torque in.lbs.	RPM	Torque in.lbs.
Max.	Min.							

2.0 HP, 1750 RPM Motor

1,095	219	C002_0020	TD370K 140-200	1,095	96	584	189	219	189
1,005	201	C102_0022	TD370K 140-200	1,005	105	536	206	201	206
914	183	C102_0024	TD370K 140-200	914	115	487	226	183	226
847	169	C102_0026	TD370K 140-200	847	124	452	244	169	244
790	158	C002_0028	TD370K 140-200	790	133	421	262	158	262
713	143	C002_0031	TD370K 140-200	713	147	380	290	143	290
659	132	C002_0033	TD370K 140-200	659	159	351	314	132	314
656	131	C102_0033	TD370K 140-200	656	160	350	315	131	315
649	130	C202_0034	TD370K 140-200	649	162	346	319	130	319
570	114	C002_0038	TD370K 140-200	570	184	304	362	114	362
563	113	C102_0039	TD370K 140-200	563	186	300	367	113	367
527	105	C002_0041	TD370K 140-200	527	199	281	392	105	392
522	104	C102_0042	TD370K 140-200	522	201	278	396	104	396
467	93	C002_0047	TD370K 140-200	467	225	258	428	93	428
470	94	C102_0047	TD370K 140-200	470	224	250	440	94	440
435	87	C102_0050	TD370K 140-200	435	241	232	475	87	475
432	86	C002_0051	TD370K 140-200	432	243	259	427	86	427
431	86	C202_0051	TD370K 140-200	431	244	230	479	86	479
376	75	C002_0058	TD370K 140-200	376	280	257	429	75	429
378	76	C202_0058	TD370K 140-200	378	278	201	547	76	547
372	74	C102_0059	TD370K 140-200	372	282	198	555	74	555
347	69	C002_0063	TD370K 140-200	347	303	255	430	69	430
345	69	C102_0063	TD370K 140-200	345	304	184	599	69	599
281	56	C102_0078	TD370K 140-200	281	374	150	737	56	737
266	53	C002_0082	TD370K 140-200	266	395	205	531	53	531
267	53	C202_0082	TD370K 140-200	267	393	142	774	53	774
265	53	C102_0083	TD370K 140-200	265	397	141	781	53	781
237	47	C002_0092	TD370K 140-200	237	443	203	531	47	531
235	47	C102_0093	TD370K 140-200	235	448	125	881	47	881
233	47	C202_0094	TD370K 140-200	233	451	124	887	47	887
212	42	C002_0105	TD370K 140-200	212	494	200	531	42	531
211	42	C102_0105	TD370K 140-200	211	499	112	981	42	981
187	37	C102_0115	TD370K 140-200	187	563	104	1,063	37	1,063
186	37	C202_0120	TD370K 140-200	186	565	99	1,111	37	1,111
176	35	C102_0125	TD370K 140-200	176	598	104	1,063	35	1,063
178	36	C202_0125	TD370K 140-200	178	591	95	1,164	36	1,164
156	31	C102_0140	TD370K 140-200	156	675	104	1,063	31	1,063
155	31	C202_0140	TD370K 140-200	155	678	83	1,334	31	1,334
139	28	C102_0155	TD370K 140-200	139	754	103	1,063	28	1,063
143	29	C202_0155	TD370K 140-200	143	734	76	1,444	29	1,444
123	25	C102_0175	TD370K 140-200	123	851	102	1,063	25	1,063
125	25	C202_0175	TD370K 140-200	125	841	67	1,656	25	1,656
105	21	C102_0210	TD370K 140-200	105	1,001	100	1,063	21	1,063
106	21	C202_0210	TD370K 140-200	106	988	63	1,772	21	1,772
105	21	C302_0210	TD370K 140-200	105	999	56	1,966	21	1,966
93	19	C302_0230	TD370K 140-200	93	1,127	50	2,218	19	2,218

¹⁾ Speed tolerance at rated load is ±3%. At less than rated load, minimum speed may increase 5%.

²⁾ The ComTrac drive operates at constant horsepower above transition values and at constant torque below transition values. Note shaded area. Engineering advances may cause slight changes to the information shown.

Housing Styles

N — Foot Mounted **F** — Round Flange **Q** — Square Flange **G** — Tapped Holes

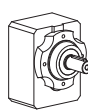
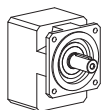
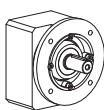
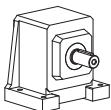

See page 78 for mounting positions.

Housing Style Q is available on special order.

Output Shaft Diameter (inches)

See Page 21 for other options.

Base Module	Dia.	Base Module	Dia.
C002	.7500	C512/C513	1.6250
C102/C103	1.0000	C612/C613	2.1250
C202/C203	1.2500	C712/C713	2.3750
C302/C303	1.2500	C812/C813	2.8750
C402/C403	1.6250	C912/C913	3.6250



"C" Series – MGS Adjustable Speed Drive Selection Data



Speed Range Output RPM ⁽¹⁾		Part Number	Maximum		Transition ⁽²⁾		Minimum	
			RPM	Torque in. lbs.	RPM	Torque in. lbs.	RPM	Torque in. lbs.
Max.	Min.							

2.0 HP, 1750 RPM Motor

Continued

93	19	C202_0240	TD370K	140-200	93	1,133	62	1,772	19	1,772
89	18	C202_0250	TD370K	140-200	89	1,183	62	1,772	18	1,772
88	18	C302_0250	TD370K	140-200	88	1,191	47	2,344	18	2,344
77	15	C202_0280	TD370K	140-200	77	1,356	61	1,772	15	1,772
78	16	C302_0280	TD370K	140-200	78	1,344	42	2,645	16	2,645
71	14	C202_0310	TD370K	140-200	71	1,474	61	1,772	14	1,772
70	14	C302_0310	TD370K	140-200	70	1,491	38	2,934	14	2,934
62	12	C202_0350	TD370K	140-200	62	1,689	60	1,772	12	1,772
62	12	C302_0350	TD370K	140-200	62	1,682	36	3,100	12	3,100
63	13	C402_0350	TD370K	140-200	63	1,672	33	3,291	13	3,291
53	11	C302_0410	TD370K	140-200	53	1,986	36	3,100	11	3,100
52	10	C402_0420	TD370K	140-200	52	2,005	28	3,946	10	3,946
47	9.4	C302_0470	TD370K	140-200	47	2,241	35	3,100	9.4	3,100
47	9.4	C402_0470	TD370K	140-200	47	2,241	25	4,411	9.4	4,411
44	8.8	C302_0500	TD370K	140-200	44	2,389	35	3,100	8.8	3,100
44	8.7	C402_0500	TD370K	140-200	44	2,410	23	4,744	8.7	4,744
39	7.8	C302_0560	TD370K	140-200	39	2,696	35	3,100	7.8	3,100
39	7.8	C402_0560	TD370K	140-200	39	2,694	23	4,872	7.8	4,872
39	7.8	C502_0560	TD370K	140-200	39	2,681	21	5,277	7.8	5,277
35	7.0	C402_0630	TD370K	140-200	35	3,002	25	4,440	7.0	4,440
35	7.0	C502_0620	TD370K	140-200	35	2,998	19	5,901	7.0	5,901
31	6.3	C402_0700	TD370K	140-200	31	3,355	22	4,872	6.3	4,872
31	6.3	C502_0700	TD370K	140-200	31	3,360	17	6,613	6.3	6,613
29	5.8	C613_0760	TD370K	140-200	29	3,588	15	7,062	5.8	7,062
27	5.4	C403_0810	TD370K	140-200	27	3,825	22	4,872	5.4	4,872
27	5.4	C503_0810	TD370K	140-200	27	3,814	15	7,086	5.4	7,086
25	5.0	C613_0880	TD370K	140-200	25	4,148	13	8,164	5.0	8,164
24	4.8	C403_0900	TD370K	140-200	24	4,275	22	4,872	4.8	4,872
24	4.8	C503_0900	TD370K	140-200	24	4,275	15	7,086	4.8	7,086
21	4.1	C613_1060	TD370K	140-200	21	5,019	11	9,879	4.1	9,879
20	4.0	C503_1090	TD370K	140-200	20	5,142	15	7,086	4.0	7,086
16	3.2	C503_1350	TD370K	140-200	16	6,405	15	7,086	3.2	7,086
16	3.2	C613_1350	TD370K	140-200	16	6,382	9	11,515	3.2	11,515
12	2.5	C613_1750	TD370K	140-200	12	8,296	9	11,515	2.5	11,515
10	2.1	C613_2130	TD370K	140-200	10	10,085	9	11,515	2.1	11,515

3.0 HP, 1750 RPM Motor

Continued next page

1,084	217	C102_0020	TD470K	180-300	1,084	150	470	347	217	347
1,005	201	C102_0022	TD470K	180-300	1,005	161	436	374	201	374
914	183	C102_0024	TD470K	180-300	914	178	396	411	183	411
884	177	C202_0025	TD470K	180-300	884	184	384	425	177	425
847	169	C102_0026	TD470K	180-300	847	191	368	444	169	444
813	163	C202_0027	TD470K	180-300	813	199	353	462	163	462
708	142	C102_0031	TD470K	180-300	708	229	307	531	142	531
656	131	C102_0033	TD470K	180-300	656	247	285	573	131	573
649	130	C202_0034	TD470K	180-300	649	250	281	580	130	580

Part No. Explanation

Selection Procedure:

- Determine the MGS/ComTrac combination according to the Input HP of the application and the Output RPM nearest the required **maximum** speed.
- Verify that the output torque will sufficiently meet the application requirements.
- Complete the Part No. per the example by adding the Housing Style letter ("N", "F", "Q" or "G") as required.

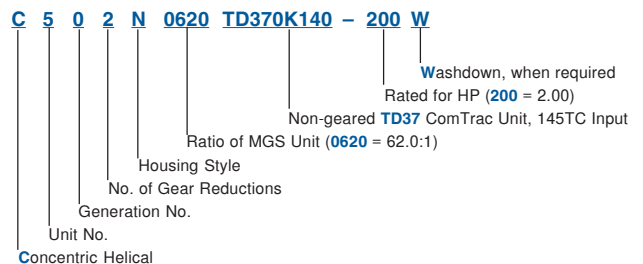



"C" Series – MGS Adjustable Speed Drive Selection Data



Speed Range Output RPM ⁽¹⁾		Part Number	Maximum		Transition ⁽²⁾		Minimum	
			RPM	Torque in.lbs.	RPM	Torque in.lbs.	RPM	Torque in.lbs.
Max.	Min.							

3.0 HP, 1750 RPM Motor

Continued

563	113	C102_0039	TD470K 180-300	563	288	244	667	113	667
522	104	C102_0042	TD470K 180-300	522	311	227	720	104	720
498	100	C402_0044	TD470K 180-300	498	326	216	755	100	755
473	95	C502_0046	TD470K 180-300	473	343	205	795	95	795
470	94	C102_0047	TD470K 180-300	470	345	204	800	94	800
435	87	C102_0050	TD470K 180-300	435	373	189	864	87	864
434	87	C302_0050	TD470K 180-300	434	374	188	866	87	866
431	86	C202_0051	TD470K 180-300	431	376	187	872	86	872
414	83	C402_0053	TD470K 180-300	414	392	180	908	83	908
378	76	C202_0058	TD470K 180-300	378	429	164	995	76	995
372	74	C102_0059	TD470K 180-300	372	436	164	996	74	996
373	75	C302_0059	TD470K 180-300	373	434	162	1,007	75	1,007
345	69	C102_0063	TD470K 180-300	345	470	166	992	69	992
347	70	C202_0063	TD470K 180-300	347	467	151	1,082	70	1,082
329	66	C402_0066	TD470K 180-300	329	493	143	1,142	66	1,142
329	66	C502_0067	TD470K 180-300	329	493	143	1,144	66	1,144
281	56	C102_0078	TD470K 180-300	281	578	169	985	56	985
280	56	C202_0078	TD470K 180-300	280	578	122	1,340	56	1,340
267	53	C202_0082	TD470K 180-300	267	607	116	1,407	53	1,407
265	53	C102_0083	TD470K 180-300	265	613	157	1,063	53	1,063
265	53	C302_0083	TD470K 180-300	265	612	115	1,418	53	1,418
235	47	C102_0093	TD470K 180-300	235	692	158	1,063	47	1,063
235	47	C302_0093	TD470K 180-300	235	690	102	1,600	47	1,600
233	47	C202_0094	TD470K 180-300	233	696	101	1,613	47	1,613
211	42	C102_0105	TD470K 180-300	211	770	158	1,063	42	1,063
213	43	C202_0105	TD470K 180-300	213	761	93	1,763	43	1,763
187	37	C102_0115	TD470K 180-300	187	869	156	1,063	37	1,063
188	38	C302_0115	TD470K 180-300	188	861	82	1,995	38	1,995
186	37	C202_0120	TD470K 180-300	186	872	93	1,772	37	1,772
176	35	C102_0125	TD470K 180-300	176	924	155	1,063	35	1,063
178	36	C202_0125	TD470K 180-300	178	913	93	1,772	36	1,772
176	35	C302_0125	TD470K 180-300	176	920	77	2,131	35	2,131
156	31	C102_0140	TD470K 180-300	156	1,042	153	1,063	31	1,063
155	31	C202_0140	TD470K 180-300	155	1,047	94	1,772	31	1,772
156	31	C302_0140	TD470K 180-300	156	1,038	68	2,405	31	2,405
143	29	C202_0155	TD470K 180-300	143	1,133	95	1,772	29	1,772
141	28	C302_0155	TD470K 180-300	141	1,153	61	2,671	28	2,671
139	28	C402_0160	TD470K 180-300	139	1,168	60	2,707	28	2,707
125	25	C202_0175	TD470K 180-300	125	1,299	94	1,772	25	1,772
125	25	C302_0175	TD470K 180-300	125	1,301	54	3,014	25	3,014
112	22	C612_0195	TD470K 180-300	112	1,454	48	3,369	22	3,369
106	21	C202_0210	TD470K 180-300	106	1,526	93	1,772	21	1,772
105	21	C302_0210	TD470K 180-300	105	1,542	53	3,100	21	3,100
93	19	C302_0230	TD470K 180-300	93	1,741	54	3,100	19	3,100
94	19	C402_0230	TD470K 180-300	94	1,732	41	4,014	19	4,014
93	19	C202_0240	TD470K 180-300	93	1,750	92	1,772	19	1,772

¹⁾ Speed tolerance at rated load is $\pm 3\%$. At less than rated load, minimum speed may increase 5%.

²⁾ The ComTrac drive operates at constant horsepower above transition values and at constant torque below transition values. Note shaded area. Engineering advances may cause slight changes to the information shown.

Housing Styles

N — Foot Mounted F — Round Flange Q — Square Flange G — Tapped Holes

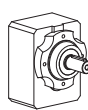
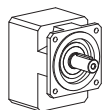
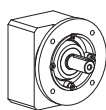
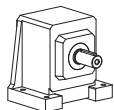

See page 78 for mounting positions.

Housing Style Q is available on special order.

Output Shaft Diameter (inches)

See Page 21 for other options.

Base Module	Dia.	Base Module	Dia.
C002	.7500	C512/C513	1.6250
C102/C103	1.0000	C612/C613	2.1250
C202/C203	1.2500	C712/C713	2.3750
C302/C303	1.2500	C812/C813	2.8750
C402/C403	1.6250	C912/C913	3.6250



"C" Series – MGS Adjustable Speed Drive Selection Data



Speed Range Output RPM ⁽¹⁾		Part Number	Maximum		Transition ⁽²⁾		Minimum	
			RPM	Torque in. lbs.	RPM	Torque in. lbs.	RPM	Torque in. lbs.
Max.	Min.							

3.0 HP, 1750 RPM Motor

Continued

88	18	C302_0250	TD470K	180-300	88	1,839	54	3,100	18	3,100
88	18	C402_0250	TD470K	180-300	88	1,848	38	4,283	18	4,283
80	16	C612_0270	TD470K	180-300	80	2,034	35	4,714	16	4,714
78	16	C302_0280	TD470K	180-300	78	2,075	54	3,100	16	3,100
79	16	C402_0280	TD470K	180-300	79	2,066	34	4,787	16	4,787
70	14	C302_0310	TD470K	180-300	70	2,302	54	3,100	14	3,100
70	14	C402_0310	TD470K	180-300	70	2,310	34	4,872	14	4,872
68	14	C612_0320	TD470K	180-300	68	2,403	29	5,569	14	5,569
65	13	C712_0340	TD470K	180-300	65	2,506	28	5,808	13	5,808
62	12	C302_0350	TD470K	180-300	62	2,597	53	3,100	12	3,100
63	13	C402_0350	TD470K	180-300	63	2,582	34	4,872	13	4,872
63	13	C502_0350	TD470K	180-300	63	2,595	27	6,015	13	6,015
56	11	C612_0390	TD470K	180-300	56	2,921	24	6,770	11	6,770
53	11	C712_0410	TD470K	180-300	53	3,042	23	7,048	11	7,048
52	10	C402_0420	TD470K	180-300	52	3,096	34	4,872	10	4,872
52	10	C502_0420	TD470K	180-300	52	3,091	23	7,086	10	7,086
48	10	C612_0450	TD470K	180-300	48	3,362	21	7,790	10	7,790
47	9.4	C402_0470	TD470K	180-300	47	3,461	34	4,872	9.4	4,872
47	9.4	C502_0470	TD470K	180-300	47	3,464	23	7,086	9.4	7,086
44	8.9	C613_0490	TD470K	180-300	44	3,601	19	8,346	8.9	8,346
44	8.8	C502_0500	TD470K	180-300	44	3,694	23	7,086	8.8	7,086
40	7.9	C612_0550	TD470K	180-300	40	4,087	17	9,471	7.9	9,471
39	7.8	C502_0560	TD470K	180-300	39	4,140	24	7,086	7.8	7,086
39	7.7	C712_0570	TD470K	180-300	39	4,213	17	9,764	7.7	9,764
34	6.9	C613_0630	TD470K	180-300	34	4,638	15	10,748	6.9	10,748
32	6.4	C612_0690	TD470K	180-300	32	5,108	14	11,515	6.4	11,515
31	6.3	C712_0700	TD470K	180-300	31	5,157	14	11,951	6.3	11,951
28	5.7	C613_0770	TD470K	180-300	28	5,613	13	12,844	5.7	12,844
28	5.5	C813_0790	TD470K	180-300	28	5,798	12	13,437	5.5	13,437
27	5.4	C713_0810	TD470K	180-300	27	5,917	12	13,713	5.4	13,713
25	4.9	C613_0890	TD470K	180-300	25	6,488	14	11,515	4.9	11,515
24	4.8	C813_0910	TD470K	180-300	24	6,638	10	15,382	4.8	15,382
22	4.5	C613_0980	TD470K	180-300	22	7,136	13	12,844	4.5	12,844
22	4.4	C713_0990	TD470K	180-300	22	7,246	10	16,791	4.4	16,791
20	4.1	C613_1070	TD470K	180-300	20	7,851	14	11,515	4.1	11,515
20	4.1	C813_1080	TD470K	180-300	20	7,862	9	18,220	4.1	18,220
17	3.4	C613_1270	TD470K	180-300	17	9,276	13	12,844	3.4	12,844
17	3.3	C713_1320	TD470K	180-300	17	9,674	8	21,259	3.3	21,259
16	3.2	C613_1370	TD470K	180-300	16	9,982	14	11,515	3.2	11,515
16	3.2	C713_1370	TD470K	180-300	16	10,037	9	17,716	3.2	17,716
16	3.2	C813_1380	TD470K	180-300	16	10,114	7	23,438	3.2	23,438
12	2.4	C713_1830	TD470K	180-300	12	13,402	9	17,716	2.4	17,716
12	2.5	C813_1780	TD470K	180-300	12	13,035	5	30,208	2.5	30,208
10	2.1	C813_2120	TD470K	180-300	10	15,501	5	31,889	2.1	31,889
10	2.0	C713_2230	TD470K	180-300	10	16,264	9	17,716	2.0	17,716
8	1.6	C813_2700	TD470K	180-300	8	19,719	5	31,889	1.6	31,889

Part No. Explanation

Selection Procedure:

- Determine the MGS/ComTrac combination according to the Input HP of the application and the Output RPM nearest the required **maximum** speed.
- Verify that the output torque will sufficiently meet the application requirements.
- Complete the Part No. per the example by adding the Housing Style letter ("N", "F", "Q" or "G") as required.

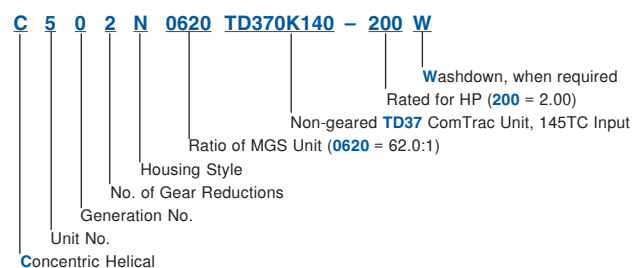



"C" Series – MGS Adjustable Speed Drive Selection Data



Speed Range		Part Number		Maximum		Transition ⁽²⁾		Minimum		
Output RPM ⁽¹⁾				RPM	Torque in.lbs.	RPM	Torque in.lbs.	RPM	Torque in.lbs.	
Max.	Min.									
5.0 HP, 1750 RPM Motor										
1,089	218	C202_0020	TD570K 180-500	1,089	255	543	518	218	518	
1,002	200	C202_0022	TD570K 180-500	1,002	277	499	563	200	563	
884	177	C202_0025	TD570K 180-500	884	314	441	638	177	638	
813	163	C202_0027	TD570K 180-500	813	342	405	693	163	693	
705	141	C202_0031	TD570K 180-500	705	394	351	800	141	800	
649	130	C202_0034	TD570K 180-500	649	428	323	869	130	869	
563	113	C202_0039	TD570K 180-500	563	494	281	1,002	113	1,002	
518	104	C202_0042	TD570K 180-500	518	537	258	1,089	104	1,089	
523	105	C302_0042	TD570K 180-500	523	531	261	1,077	105	1,077	
498	100	C402_0044	TD570K 180-500	498	558	248	1,133	100	1,133	
473	95	C502_0046	TD570K 180-500	473	588	236	1,193	95	1,193	
469	94	C202_0047	TD570K 180-500	469	593	234	1,203	94	1,203	
468	94	C302_0047	TD570K 180-500	468	594	233	1,205	94	1,205	
434	87	C302_0050	TD570K 180-500	434	640	216	1,299	87	1,299	
431	86	C202_0051	TD570K 180-500	431	644	215	1,307	86	1,307	
414	83	C402_0053	TD570K 180-500	414	671	206	1,362	83	1,362	
378	76	C202_0058	TD570K 180-500	378	735	197	1,431	76	1,431	
373	75	C302_0059	TD570K 180-500	373	744	186	1,510	75	1,510	
347	70	C202_0063	TD570K 180-500	347	799	198	1,427	70	1,427	
346	69	C302_0063	TD570K 180-500	346	802	173	1,628	69	1,628	
329	66	C402_0066	TD570K 180-500	329	844	164	1,714	66	1,714	
329	66	C502_0067	TD570K 180-500	329	845	164	1,715	66	1,715	
280	56	C202_0078	TD570K 180-500	280	990	201	1,422	56	1,422	
279	56	C302_0078	TD570K 180-500	279	996	139	2,021	56	2,021	
267	53	C202_0082	TD570K 180-500	267	1,040	160	1,772	53	1,772	
265	53	C302_0083	TD570K 180-500	265	1,048	132	2,127	53	2,127	
235	47	C302_0093	TD570K 180-500	235	1,182	117	2,400	47	2,400	
233	47	C202_0094	TD570K 180-500	233	1,192	161	1,772	47	1,772	
213	43	C202_0105	TD570K 180-500	213	1,303	161	1,772	43	1,772	
213	43	C302_0105	TD570K 180-500	213	1,306	106	2,651	43	2,651	
188	38	C302_0115	TD570K 180-500	188	1,474	94	2,992	38	2,992	
188	38	C402_0115	TD570K 180-500	188	1,478	94	2,999	38	2,999	
186	37	C202_0120	TD570K 180-500	186	1,493	159	1,772	37	1,772	
178	36	C202_0125	TD570K 180-500	178	1,564	159	1,772	36	1,772	
176	35	C302_0125	TD570K 180-500	176	1,575	91	3,100	35	3,100	
175	35	C402_0125	TD570K 180-500	175	1,590	87	3,227	35	3,227	
156	31	C302_0140	TD570K 180-500	156	1,777	91	3,100	31	3,100	
156	31	C402_0140	TD570K 180-500	156	1,777	78	3,607	31	3,607	
141	28	C302_0155	TD570K 180-500	141	1,974	92	3,100	28	3,100	
139	28	C502_0155	TD570K 180-500	139	1,995	69	4,049	28	4,049	
139	28	C402_0160	TD570K 180-500	139	2,000	69	4,060	28	4,060	
125	25	C302_0175	TD570K 180-500	125	2,227	92	3,100	25	3,100	
124	25	C402_0175	TD570K 180-500	124	2,235	62	4,538	25	4,538	
112	22	C612_0195	TD570K 180-500	112	2,490	56	5,054	22	5,054	
105	21	C302_0210	TD570K 180-500	105	2,641	91	3,100	21	3,100	
105	21	C402_0210	TD570K 180-500	105	2,654	58	4,872	21	4,872	

¹⁾ Speed tolerance at rated load is $\pm 3\%$. At less than rated load, minimum speed may increase 5%.

²⁾ The ComTrac drive operates at constant horsepower above transition values and at constant torque below transition values. Note shaded area. Engineering advances may cause slight changes to the information shown.

Housing Styles

N — Foot Mounted F — Round Flange Q — Square Flange G — Tapped Holes

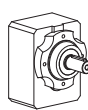
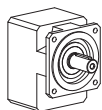
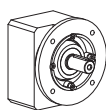
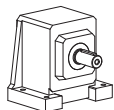

See page 78 for mounting positions.
Housing Style Q is available on special order.

Output Shaft Diameter (inches)

See Page 21 for other options.

Base Module	Dia.	Base Module	Dia.
C002	.7500	C512/C513	1.6250
C102/C103	1.0000	C612/C613	2.1250
C202/C203	1.2500	C712/C713	2.3750
C302/C303	1.2500	C812/C813	2.8750
C402/C403	1.6250	C912/C913	3.6250



"C" Series – MGS Adjustable Speed Drive Selection Data



Speed Range Output RPM ⁽¹⁾		Part Number	Maximum		Transition ⁽²⁾		Minimum	
			RPM	Torque in. lbs.	RPM	Torque in. lbs.	RPM	Torque in. lbs.
Max.	Min.							

5.0 HP, 1750 RPM Motor

Continued

105	21	C502_0210	TD570K 180-500	105	2,647	52	5,373	21	5,373
93	19	C302_0230	TD570K 180-500	93	2,981	90	3,100	19	3,100
94	19	C402_0230	TD570K 180-500	94	2,966	58	4,872	19	4,872
94	19	C502_0230	TD570K 180-500	94	2,966	47	6,021	19	6,021
88	18	C402_0250	TD570K 180-500	88	3,165	59	4,872	18	4,872
87	17	C502_0250	TD570K 180-500	87	3,184	43	6,463	17	6,463
80	16	C612_0270	TD570K 180-500	80	3,483	40	7,070	16	7,070
79	16	C402_0280	TD570K 180-500	79	3,537	59	4,872	16	4,872
78	16	C502_0280	TD570K 180-500	78	3,568	40	7,086	16	7,086
70	14	C402_0310	TD570K 180-500	70	3,956	58	4,872	14	4,872
70	14	C502_0310	TD570K 180-500	70	3,966	40	7,086	14	7,086
68	14	C612_0320	TD570K 180-500	68	4,115	34	8,353	14	8,353
65	13	C712_0340	TD570K 180-500	65	4,292	32	8,712	13	8,712
63	13	C402_0350	TD570K 180-500	63	4,422	58	4,872	13	4,872
63	13	C502_0350	TD570K 180-500	63	4,445	40	7,086	13	7,086
63	13	C612_0350	TD570K 180-500	63	4,428	31	8,989	13	8,989
56	11	C612_0390	TD570K 180-500	56	5,003	28	10,155	11	10,155
53	11	C712_0410	TD570K 180-500	53	5,208	27	10,573	11	10,573
52	10	C502_0420	TD570K 180-500	52	5,294	40	7,086	10	7,086
48	10	C612_0450	TD570K 180-500	48	5,757	24	11,515	10	11,515
47	9.4	C502_0470	TD570K 180-500	47	5,933	40	7,086	9.4	7,086
47	9.3	C712_0470	TD570K 180-500	47	5,945	23	12,068	9.3	12,068
44	8.9	C613_0490	TD570K 180-500	44	6,167	22	12,519	8.9	12,519
44	8.8	C502_0500	TD570K 180-500	44	6,327	40	7,086	8.8	7,086
40	7.9	C612_0550	TD570K 180-500	40	6,998	25	11,515	7.9	11,515
39	7.7	C712_0570	TD570K 180-500	39	7,215	19	14,646	7.7	14,646
34	6.9	C613_0630	TD570K 180-500	34	7,942	22	12,844	6.9	12,844
32	6.4	C612_0690	TD570K 180-500	32	8,748	25	11,515	6.4	11,515
31	6.3	C712_0700	TD570K 180-500	31	8,831	16	17,716	6.3	17,716
28	5.7	C613_0770	TD570K 180-500	28	9,611	22	12,844	5.7	12,844
28	5.5	C813_0790	TD570K 180-500	28	9,930	14	20,156	5.5	20,156
27	5.4	C713_0810	TD570K 180-500	27	10,133	13	20,569	5.4	20,569
25	4.9	C613_0890	TD570K 180-500	25	11,111	24	11,515	4.9	11,515
24	4.8	C813_0910	TD570K 180-500	24	11,367	12	23,073	4.8	23,073
22	4.5	C613_0980	TD570K 180-500	22	12,219	21	12,844	4.5	12,844
22	4.4	C713_0990	TD570K 180-500	22	12,408	13	21,259	4.4	21,259
20	4.1	C813_1080	TD570K 180-500	20	13,464	10	27,330	4.1	27,330
17	3.3	C713_1320	TD570K 180-500	17	16,567	13	21,259	3.3	21,259
16	3.2	C713_1370	TD570K 180-500	16	17,188	16	17,716	3.2	17,716
16	3.2	C813_1380	TD570K 180-500	16	17,320	9	31,889	3.2	31,889
12	2.5	C813_1780	TD570K 180-500	12	22,322	9	31,889	2.5	31,889
10	2.1	C813_2120	TD570K 180-500	10	26,545	9	31,889	2.1	31,889

Part No. Explanation

Selection Procedure:

- Determine the MGS/ComTrac combination according to the Input HP of the application and the Output RPM nearest the required **maximum** speed.
- Verify that the output torque will sufficiently meet the application requirements.
- Complete the Part No. per the example by adding the Housing Style letter ("N", "F", "Q" or "G") as required.

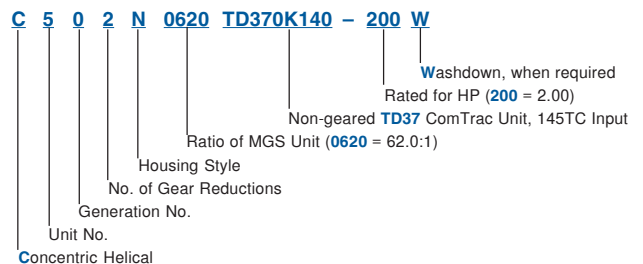



"C" Series – MGS Adjustable Speed Drive Selection Data



Speed Range		Part Number	Maximum		Transition ⁽²⁾		Minimum	
Output RPM ⁽¹⁾			RPM	Torque in.lbs.	RPM	Torque in.lbs.	RPM	Torque in.lbs.
Max.	Min.							

7.5 HP, 1750 RPM Motor

1,083	217	C302_0020	TD670K 210-750	1,083	381	590	712	217	712
1,005	201	C302_0022	TD670K 210-750	1,005	411	548	767	201	767
872	174	C302_0025	TD670K 210-750	872	474	475	884	174	884
809	162	C302_0027	TD670K 210-750	809	511	441	953	162	953
789	158	C402_0028	TD670K 210-750	789	523	430	976	158	976
703	141	C302_0031	TD670K 210-750	703	587	383	1,096	141	1,096
653	131	C302_0034	TD670K 210-750	653	633	356	1,181	131	1,181
626	125	C402_0035	TD670K 210-750	626	660	341	1,232	125	1,232
564	113	C302_0039	TD670K 210-750	564	732	308	1,366	113	1,366
523	105	C302_0042	TD670K 210-750	523	789	285	1,472	105	1,472
514	103	C712_0043	TD670K 210-750	514	804	280	1,500	103	1,500
498	100	C402_0044	TD670K 210-750	498	829	271	1,548	100	1,548
473	95	C502_0046	TD670K 210-750	473	874	258	1,631	95	1,631
468	94	C302_0047	TD670K 210-750	468	882	255	1,647	94	1,647
434	87	C302_0050	TD670K 210-750	434	951	237	1,775	87	1,775
430	86	C612_0051	TD670K 210-750	430	959	235	1,791	86	1,791
414	83	C402_0053	TD670K 210-750	414	997	226	1,861	83	1,861
373	75	C302_0059	TD670K 210-750	373	1,106	204	2,064	75	2,064
371	74	C402_0059	TD670K 210-750	371	1,102	202	2,075	74	2,075
346	69	C302_0063	TD670K 210-750	346	1,192	189	2,224	69	2,224
336	67	C612_0065	TD670K 210-750	336	1,230	183	2,296	67	2,296
329	66	C402_0066	TD670K 210-750	329	1,255	179	2,342	66	2,342
329	66	C502_0067	TD670K 210-750	329	1,256	179	2,344	66	2,344
321	64	C712_0068	TD670K 210-750	321	1,286	175	2,399	64	2,399
308	62	C612_0071	TD670K 210-750	308	1,342	168	2,505	62	2,505
297	59	C712_0074	TD670K 210-750	297	1,389	162	2,592	59	2,592
279	56	C302_0078	TD670K 210-750	279	1,480	173	2,447	56	2,447
280	56	C402_0078	TD670K 210-750	280	1,475	153	2,753	56	2,753
267	53	C612_0082	TD670K 210-750	267	1,546	146	2,885	53	2,885
265	53	C302_0083	TD670K 210-750	265	1,557	145	2,906	53	2,906
264	53	C402_0083	TD670K 210-750	264	1,564	144	2,919	53	2,919
258	52	C712_0085	TD670K 210-750	258	1,602	140	2,991	52	2,991
240	48	C612_0091	TD670K 210-750	240	1,721	131	3,212	48	3,212
235	47	C302_0093	TD670K 210-750	235	1,757	136	3,100	47	3,100
236	47	C402_0093	TD670K 210-750	236	1,748	129	3,262	47	3,262
232	46	C712_0094	TD670K 210-750	232	1,781	126	3,324	46	3,324
221	44	C712_0099	TD670K 210-750	221	1,871	120	3,492	44	3,492
216	43	C612_0100	TD670K 210-750	216	1,908	118	3,562	43	3,562
213	43	C302_0105	TD670K 210-750	213	1,941	137	3,100	43	3,100
210	42	C402_0105	TD670K 210-750	210	1,965	115	3,667	42	3,667
188	38	C302_0115	TD670K 210-750	188	2,191	137	3,100	38	3,100
188	38	C402_0115	TD670K 210-750	188	2,196	102	4,099	38	4,099
186	37	C712_0120	TD670K 210-750	186	2,220	101	4,143	37	4,143
176	35	C302_0125	TD670K 210-750	176	2,340	136	3,100	35	3,100
175	35	C402_0125	TD670K 210-750	175	2,363	95	4,410	35	4,410
166	33	C712_0130	TD670K 210-750	166	2,488	90	4,644	33	4,644

¹⁾ Speed tolerance at rated load is ±3%. At less than rated load, minimum speed may increase 5%.

²⁾ The ComTrac drive operates at constant horsepower above transition values and at constant torque below transition values. Note shaded area. Engineering advances may cause slight changes to the information shown.

Housing Styles

N — Foot Mounted F — Round Flange Q — Square Flange G — Tapped Holes

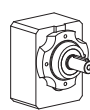
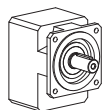
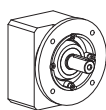
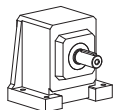

See page 78 for mounting positions.

Housing Style Q is available on special order.

Output Shaft Diameter (inches)

See Page 21 for other options.

Base Module	Dia.	Base Module	Dia.
C002	.7500	C512/C513	1.6250
C102/C103	1.0000	C612/C613	2.1250
C202/C203	1.2500	C712/C713	2.3750
C302/C303	1.2500	C812/C813	2.8750
C402/C403	1.6250	C912/C913	3.6250



"C" Series – MGS Adjustable Speed Drive Selection Data



Speed Range Output RPM ⁽¹⁾		Part Number	Maximum		Transition ⁽²⁾		Minimum	
			RPM	Torque in. lbs.	RPM	Torque in. lbs.	RPM	Torque in. lbs.
Max.	Min.							

7.5 HP, 1750 RPM Motor

Continued next page

159	32	C712_0135	TD670K 210-750	159	2,592	87	4,837	32	4,837
156	31	C302_0140	TD670K 210-750	156	2,641	135	3,100	31	3,100
156	31	C402_0140	TD670K 210-750	156	2,641	86	4,872	31	4,872
157	31	C502_0140	TD670K 210-750	157	2,629	86	4,907	31	4,907
141	28	C302_0155	TD670K 210-750	141	2,934	134	3,100	28	3,100
139	28	C502_0155	TD670K 210-750	139	2,965	76	5,534	28	5,534
139	28	C402_0160	TD670K 210-750	139	2,973	87	4,872	28	4,872
135	27	C612_0160	TD670K 210-750	135	3,058	74	5,708	27	5,708
131	26	C712_0165	TD670K 210-750	131	3,159	71	5,895	26	5,895
128	26	C812_0170	TD670K 210-750	128	3,228	70	6,024	26	6,024
124	25	C402_0175	TD670K 210-750	124	3,323	87	4,872	25	4,872
124	25	C502_0175	TD670K 210-750	124	3,323	68	6,202	25	6,202
120	24	C712_0185	TD670K 210-750	120	3,447	65	6,433	24	6,433
112	22	C612_0195	TD670K 210-750	112	3,701	61	6,907	22	6,907
108	22	C812_0200	TD670K 210-750	108	3,823	59	7,136	22	7,136
105	21	C402_0210	TD670K 210-750	105	3,945	86	4,872	21	4,872
105	21	C502_0210	TD670K 210-750	105	3,934	59	7,086	21	7,086
106	21	C712_0210	TD670K 210-750	106	3,902	58	7,282	21	7,282
94	19	C402_0230	TD670K 210-750	94	4,409	86	4,872	19	4,872
94	19	C502_0230	TD670K 210-750	94	4,409	60	7,086	19	7,086
97	19	C612_0230	TD670K 210-750	97	4,278	53	7,985	19	7,985
87	17	C502_0250	TD670K 210-750	87	4,733	60	7,086	17	7,086
88	18	C612_0250	TD670K 210-750	88	4,705	48	8,782	18	8,782
84	17	C812_0260	TD670K 210-750	84	4,918	46	9,180	17	9,180
80	16	C612_0270	TD670K 210-750	80	5,177	43	9,663	16	9,663
78	16	C502_0280	TD670K 210-750	78	5,304	60	7,086	16	7,086
76	15	C712_0290	TD670K 210-750	76	5,405	42	10,088	15	10,088
68	14	C612_0320	TD670K 210-750	68	6,117	37	11,416	14	11,416
65	13	C712_0340	TD670K 210-750	65	6,379	35	11,906	13	11,906
63	13	C612_0350	TD670K 210-750	63	6,582	37	11,515	13	11,515
62	12	C712_0350	TD670K 210-750	62	6,618	34	12,353	12	12,353
55	11	C812_0400	TD670K 210-750	55	7,538	30	14,069	11	14,069
53	11	C712_0410	TD670K 210-750	53	7,742	29	14,449	11	14,449
48	10	C612_0450	TD670K 210-750	48	8,557	37	11,515	10	11,515
48	10	C812_0460	TD670K 210-750	48	8,595	26	16,042	10	16,042
47	9.3	C712_0470	TD670K 210-750	47	8,837	25	16,493	9.3	16,493
44	8.9	C813_0490	TD670K 210-750	44	9,148	24	17,074	8.9	17,074
43	8.6	C713_0510	TD670K 210-750	43	9,458	23	17,653	8.6	17,653
40	8.1	C812_0540	TD670K 210-750	40	10,222	22	19,078	8.1	19,078
39	7.7	C712_0570	TD670K 210-750	39	10,724	24	17,716	7.7	17,716
34	6.8	C713_0650	TD670K 210-750	34	12,007	20	21,259	6.8	21,259
33	6.6	C813_0660	TD670K 210-750	33	12,271	18	22,902	6.6	22,902
32	6.4	C812_0690	TD670K 210-750	32	13,003	17	24,268	6.4	24,268
28	5.6	C813_0780	TD670K 210-750	28	14,535	15	27,128	5.6	27,128
27	5.5	C713_0800	TD670K 210-750	27	14,832	20	21,259	5.5	21,259
24	4.9	C713_0890	TD670K 210-750	24	16,634	23	17,716	4.9	17,716

Part No. Explanation

Selection Procedure:

- Determine the MGS/ComTrac combination according to the Input HP of the application and the Output RPM nearest the required **maximum** speed.
- Verify that the output torque will sufficiently meet the application requirements.
- Complete the Part No. per the example by adding the Housing Style letter ("N", "F", "Q" or "G") as required.

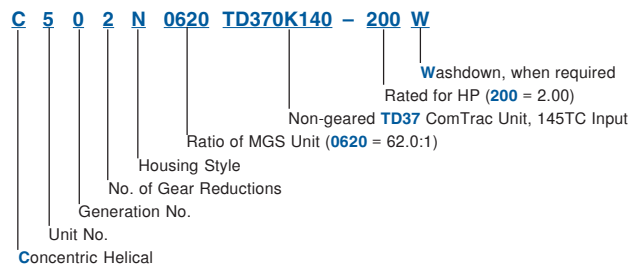



"C" Series – MGS Adjustable Speed Drive Selection Data



Speed Range Output RPM ⁽¹⁾		Part Number	Maximum		Transition ⁽²⁾		Minimum	
			RPM	Torque in.lbs.	RPM	Torque in.lbs.	RPM	Torque in.lbs.
Max.	Min.							

7.5 HP, 1750 RPM Motor Continued

24	4.9	C813_0890	TD670K 210-750	24	16,638	13	31,054	4.9	31,054
24	4.8	C913_0900	TD670K 210-750	24	16,783	13	31,324	4.8	31,324
22	4.5	C713_0980	TD670K 210-750	22	18,162	19	21,259	4.5	21,259
22	4.4	C813_1010	TD670K 210-750	22	18,698	12	34,897	4.4	34,897
21	4.1	C813_1060	TD670K 210-750	21	19,708	13	31,889	4.1	31,889
20	4.0	C913_1100	TD670K 210-750	20	20,543	11	38,342	4.0	38,342
17	3.4	C813_1300	TD670K 210-750	17	24,098	11	37,204	3.4	37,204
16	3.2	C813_1360	TD670K 210-750	16	25,353	13	31,889	3.2	31,889
16	3.2	C913_1390	TD670K 210-750	16	25,834	9	48,217	3.2	48,217
12	2.5	C913_1760	TD670K 210-750	12	32,758	8	53,148	2.5	53,148
10	2.0	C913_2150	TD670K 210-750	10	40,062	8	53,148	2.0	53,148

10.0 HP, 1750 RPM Motor Continued next page

1,139	228	C502_0020	TD760K 210-1000	1,139	505	604	951	228	951
1,001	200	C502_0022	TD760K 210-1000	1,001	575	531	1,081	200	1,081
918	184	C502_0025	TD760K 210-1000	918	627	487	1,179	184	1,179
807	161	C502_0028	TD760K 210-1000	807	713	428	1,341	161	1,341
731	146	C502_0031	TD760K 210-1000	731	787	388	1,481	146	1,481
643	129	C502_0035	TD760K 210-1000	643	895	341	1,685	129	1,685
582	116	C502_0039	TD760K 210-1000	582	989	309	1,861	116	1,861
538	108	C612_0042	TD760K 210-1000	538	1,070	285	2,013	108	2,013
511	102	C502_0044	TD760K 210-1000	511	1,125	271	2,117	102	2,117
486	97	C502_0046	TD760K 210-1000	486	1,184	258	2,227	97	2,227
443	89	C612_0051	TD760K 210-1000	443	1,300	235	2,446	89	2,446
427	85	C502_0053	TD760K 210-1000	427	1,347	227	2,533	85	2,533
385	77	C502_0059	TD760K 210-1000	385	1,496	204	2,815	77	2,815
345	69	C612_0065	TD760K 210-1000	345	1,667	183	3,136	69	3,136
338	68	C502_0067	TD760K 210-1000	338	1,702	179	3,202	68	3,202
330	66	C712_0068	TD760K 210-1000	330	1,742	175	3,277	66	3,277
316	63	C612_0071	TD760K 210-1000	316	1,819	168	3,422	63	3,422
290	58	C502_0078	TD760K 210-1000	290	1,985	154	3,735	58	3,735
275	55	C612_0082	TD760K 210-1000	275	2,095	146	3,941	55	3,941
272	54	C502_0083	TD760K 210-1000	272	2,113	144	3,976	54	3,976
265	53	C712_0085	TD760K 210-1000	265	2,171	141	4,085	53	4,085
247	49	C612_0091	TD760K 210-1000	247	2,332	131	4,387	49	4,387
243	49	C502_0093	TD760K 210-1000	243	2,369	129	4,456	49	4,456
238	48	C712_0094	TD760K 210-1000	238	2,413	126	4,540	48	4,540
227	45	C712_0099	TD760K 210-1000	227	2,535	120	4,769	45	4,769
223	45	C612_0100	TD760K 210-1000	223	2,586	118	4,865	45	4,865
217	43	C502_0105	TD760K 210-1000	217	2,655	115	4,996	43	4,996
193	39	C502_0115	TD760K 210-1000	193	2,976	103	5,599	39	5,599
191	38	C712_0120	TD760K 210-1000	191	3,008	101	5,659	38	5,659
181	36	C502_0125	TD760K 210-1000	181	3,179	96	5,980	36	5,980
171	34	C712_0130	TD760K 210-1000	171	3,371	91	6,343	34	6,343
164	33	C712_0135	TD760K 210-1000	164	3,511	87	6,606	33	6,606

¹⁾ Speed tolerance at rated load is ±3%. At less than rated load, minimum speed may increase 5%.

²⁾ The ComTrac drive operates at constant horsepower above transition values and at constant torque below transition values. Note shaded area. Engineering advances may cause slight changes to the information shown.

Housing Styles

N — Foot Mounted **F** — Round Flange **Q** — Square Flange **G** — Tapped Holes

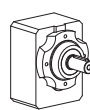
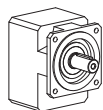
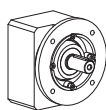
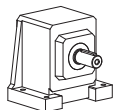

See page 78 for mounting positions.
Housing Style Q is available on special order.

Output Shaft Diameter (inches)

See Page 21 for other options.

Base Module	Dia.	Base Module	Dia.
C002	.7500	C512/C513	1.6250
C102/C103	1.0000	C612/C613	2.1250
C202/C203	1.2500	C712/C713	2.3750
C302/C303	1.2500	C812/C813	2.8750
C402/C403	1.6250	C912/C913	3.6250



"C" Series – MGS Adjustable Speed Drive Selection Data



Speed Range Output RPM ⁽¹⁾		Part Number	Maximum		Transition ⁽²⁾		Minimum	
			RPM	Torque in. lbs.	RPM	Torque in. lbs.	RPM	Torque in. lbs.
Max.	Min.							

10.0 HP, 1750 RPM Motor Continued

162	32	C502_0140	TD760K 210-1000	162	3,562	86	6,702	32	6,702
143	29	C502_0155	TD760K 210-1000	143	4,017	81	7,086	29	7,086
139	28	C612_0160	TD760K 210-1000	139	4,144	74	7,796	28	7,796
134	27	C712_0165	TD760K 210-1000	134	4,280	71	8,052	27	8,052
132	26	C812_0170	TD760K 210-1000	132	4,374	70	8,228	26	8,228
128	26	C502_0175	TD760K 210-1000	128	4,502	82	7,086	26	7,086
128	26	C612_0175	TD760K 210-1000	128	4,501	68	8,469	26	8,469
123	25	C712_0185	TD760K 210-1000	123	4,670	65	8,787	25	8,787
115	23	C612_0195	TD760K 210-1000	115	5,014	61	9,434	23	9,434
111	22	C812_0200	TD760K 210-1000	111	5,181	59	9,747	22	9,747
108	22	C502_0210	TD760K 210-1000	108	5,331	83	7,086	22	7,086
109	22	C712_0210	TD760K 210-1000	109	5,287	58	9,947	22	9,947
96	19	C502_0230	TD760K 210-1000	96	5,974	82	7,086	19	7,086
99	20	C612_0230	TD760K 210-1000	99	5,797	53	10,907	20	10,907
90	18	C502_0250	TD760K 210-1000	90	6,412	82	7,086	18	7,086
90	18	C612_0250	TD760K 210-1000	90	6,375	48	11,995	18	11,995
86	17	C812_0260	TD760K 210-1000	86	6,664	46	12,538	17	12,538
82	16	C612_0270	TD760K 210-1000	82	7,015	50	11,515	16	11,515
82	16	C812_0270	TD760K 210-1000	82	7,025	43	13,216	16	13,216
79	16	C712_0290	TD760K 210-1000	79	7,324	42	13,779	16	13,779
69	14	C612_0320	TD760K 210-1000	69	8,288	45	12,844	14	12,844
70	14	C912_0320	TD760K 210-1000	70	8,218	37	15,462	14	15,462
67	13	C712_0340	TD760K 210-1000	67	8,644	35	16,262	13	16,262
65	13	C612_0350	TD760K 210-1000	65	8,919	51	11,515	13	11,515
64	13	C712_0350	TD760K 210-1000	64	8,968	34	16,872	13	16,872
62	12	C912_0360	TD760K 210-1000	62	9,208	33	17,324	12	17,324
57	11	C912_0390	TD760K 210-1000	57	10,050	30	18,909	11	18,909
56	11	C812_0400	TD760K 210-1000	56	10,214	30	19,217	11	19,217
55	11	C712_0410	TD760K 210-1000	55	10,490	31	18,554	11	18,554
49	10	C812_0460	TD760K 210-1000	49	11,646	26	21,911	10	21,911
48	10	C712_0470	TD760K 210-1000	48	11,974	33	17,716	10	17,716
42	8.3	C812_0540	TD760K 210-1000	42	13,850	22	26,057	8.3	26,057
40	8.1	C912_0560	TD760K 210-1000	40	14,279	21	26,865	8.1	26,865
40	7.9	C712_0570	TD760K 210-1000	40	14,531	33	17,716	7.9	17,716
35	7.0	C913_0650	TD760K 210-1000	35	16,279	18	30,628	7.0	30,628
33	6.5	C812_0690	TD760K 210-1000	33	17,618	18	31,889	6.5	31,889
32	6.4	C912_0700	TD760K 210-1000	32	17,894	17	33,665	6.4	33,665
28	5.7	C913_0790	TD760K 210-1000	28	19,927	15	37,491	5.7	37,491
25	4.9	C913_0920	TD760K 210-1000	25	23,129	13	43,515	4.9	43,515
23	4.5	C913_0990	TD760K 210-1000	23	25,059	12	47,146	4.5	47,146
20	4.0	C913_1120	TD760K 210-1000	20	28,312	11	53,148	4.0	53,148
18	3.6	C913_1260	TD760K 210-1000	18	31,776	9	59,782	3.6	59,782
16	3.2	C913_1410	TD760K 210-1000	16	35,603	11	53,148	3.2	53,148
13	2.5	C913_1790	TD760K 210-1000	13	45,146	11	53,148	2.5	53,148

Part No. Explanation

Selection Procedure:

- Determine the MGS/ComTrac combination according to the Input HP of the application and the Output RPM nearest the required **maximum** speed.
- Verify that the output torque will sufficiently meet the application requirements.
- Complete the Part No. per the example by adding the Housing Style letter ("N", "F", "Q" or "G") as required.

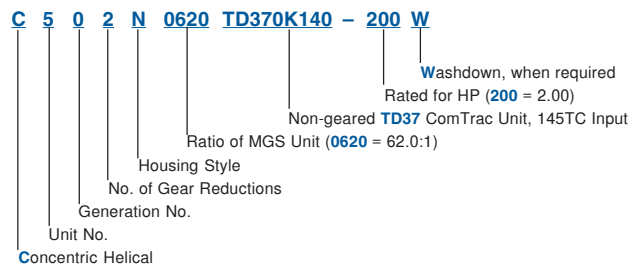



"C" Series – MGS® Adjustable Speed Drives Dimensional Data



Drawing for Units
C002N — C503N

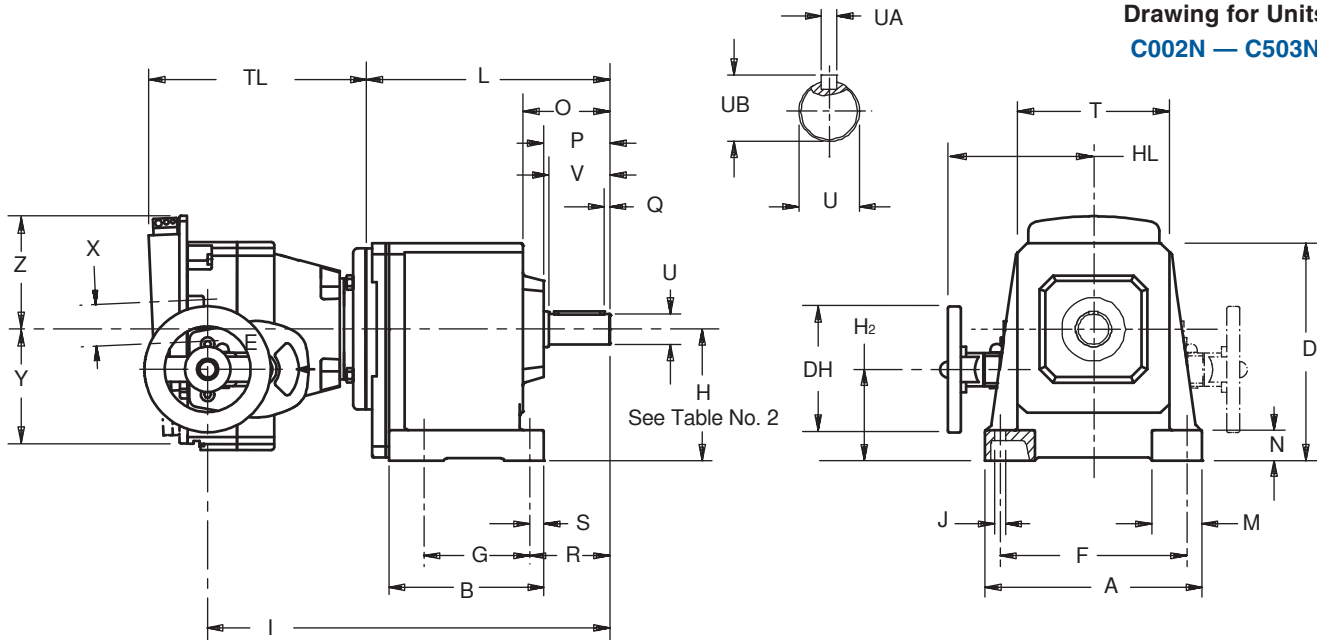

Table No. 1 "C" Series with ComTrac – Foot Mounting Unit Dimensions (Inches) – "N" Housing Style

Base Module	A	B	D	F	G	H	J	M	N	O	P	Q	R	S	T	V	Z ₁
C002	5.20	3.74	5.67	4.33	2.44	3.23	.28	1.38	.79	2.24	1.73	.16	2.17	.43	3.62	1.57	—
C102/C103	6.93	4.65	6.97	5.91	2.76	4.02	.35	1.65	.98	2.72	2.13	.16	2.64	.51	4.88	1.97	—
C202/C203	7.87	5.31	7.68	6.69	3.35	4.53 ¹⁾	.43	1.97	1.18	3.39	2.56	.16	3.11	.55	5.43	2.36	—
C302/C303	8.46	6.06	8.46	7.28	4.13	5.12 ¹⁾	.43	1.97	1.18	3.35	2.56	.16	3.11	.55	5.91	2.36	—
C402/C403	10.04	7.09	9.65	8.66	4.33	5.71	.55	2.36	1.38	4.17	3.39	.16	4.13	.75	6.89	3.15	—
C502/C503	11.42	7.76	11.42	9.65	5.12	6.69	.71	2.76	1.57	4.21	3.39	.16	4.25	.87	7.56	3.15	—
C612/C613	11.81	10.43	12.40	9.65	8.46	7.87 ¹⁾	.71	2.95	1.57	6.02	4.17	.20	5.12	.98	6.97	3.94	6.57
C712/C713	14.37	11.22	14.76	11.81	9.25	9.25 ¹⁾	.71	3.54	1.97	7.28	5.00	.20	6.42	.98	7.56	4.72	7.91
C812/C813	17.13	14.17	17.72	13.39	11.81	11.42	.87	3.74	2.17	8.58	5.83	.39	7.48	1.14	8.78	5.51	8.70
C912/C913	20.08	16.14	20.87	15.75	13.39	13.39	1.02	4.33	2.36	10.08	7.01	.39	8.74	1.34	10.91	6.69	10.24

¹⁾ See Table No. 2. These sizes are not coaxial. H=Output Height, H₁=Input Height.

Table No. 2 H₁ Dimension (Inches)

Base Module	TD27	TD37	TD47	TD57	TD67	TD76
C203	3.07	—	—	—	—	—
C303	3.66	3.66	—	—	—	—
C612	—	—	7.64	7.64	7.64	7.64
C613	7.64	7.64	7.64	7.64	—	—
C713	—	—	—	—	8.50	—

These sizes are not coaxial.
H=Output Height, H₁=Input Height.

Table No. 3 "C" Series Shaft Dimensions (Inches)

Base Module	U	Tolerance	UA—Key	UB
C002	.7500	+0.0000/-0.0006	$\frac{3}{16} \times \frac{3}{16} \times \frac{17}{32}$.83
C102/C103	1.0000	+0.0000/-0.0006	$\frac{1}{4} \times \frac{1}{4} \times \frac{19}{16}$	1.11
C202/C203	1.2500	+0.0000/-0.0007	$\frac{1}{4} \times \frac{1}{4} \times \frac{115}{16}$	1.36
C302/C303	1.2500	+0.0000/-0.0007	$\frac{1}{4} \times \frac{1}{4} \times \frac{115}{16}$	1.36
C402/C403	1.6250	+0.0000/-0.0007	$\frac{3}{8} \times \frac{3}{8} \times \frac{27}{8}$	1.79
C502/C503	1.6250	+0.0000/-0.0007	$\frac{3}{8} \times \frac{3}{8} \times \frac{27}{8}$	1.79
C612/C613	2.1250	+0.0000/-0.0008	$\frac{1}{2} \times \frac{1}{2} \times \frac{35}{32}$	2.35
C712/C713	2.3750	+0.0000/-0.0008	$\frac{5}{8} \times \frac{5}{8} \times \frac{315}{16}$	2.65
C812/C813	2.8750	+0.0000/-0.0008	$\frac{3}{4} \times \frac{3}{4} \times \frac{45}{16}$	3.21
C912/C913	3.6250	+0.0000/-0.0009	$\frac{7}{8} \times \frac{7}{8} \times \frac{51}{2}$	4.01

Table No. 4

"C" Series with ComTrac Dimensions (Inches)

ComTrac Part No.	NEMA C-Flange	DH	HL	TL	X	Y	Z
TD270K050	56C	4.92	5.67	7.87	2.09	5.55	4.41
TD270K140	143/145TC	4.92	5.67	7.87	2.09	5.55	4.41
TD370K140	143/145TC	4.92	5.91	8.50	2.17	5.67	4.37
TD470K180	182/184TC	6.30	6.81	8.94	2.80	7.20	5.59
TD570K180	182/184TC	7.87	8.31	11.89	3.11	8.11	6.30
TD670K210	213/215TC	7.87	9.17	12.17	3.86	9.02	7.13
TD760K210	213/215TC	9.84	9.72	14.25	4.29	9.37	7.68



"C" Series – MGS® Adjustable Speed Drives Dimensional Data



Drawing for Units
C612N — C913N

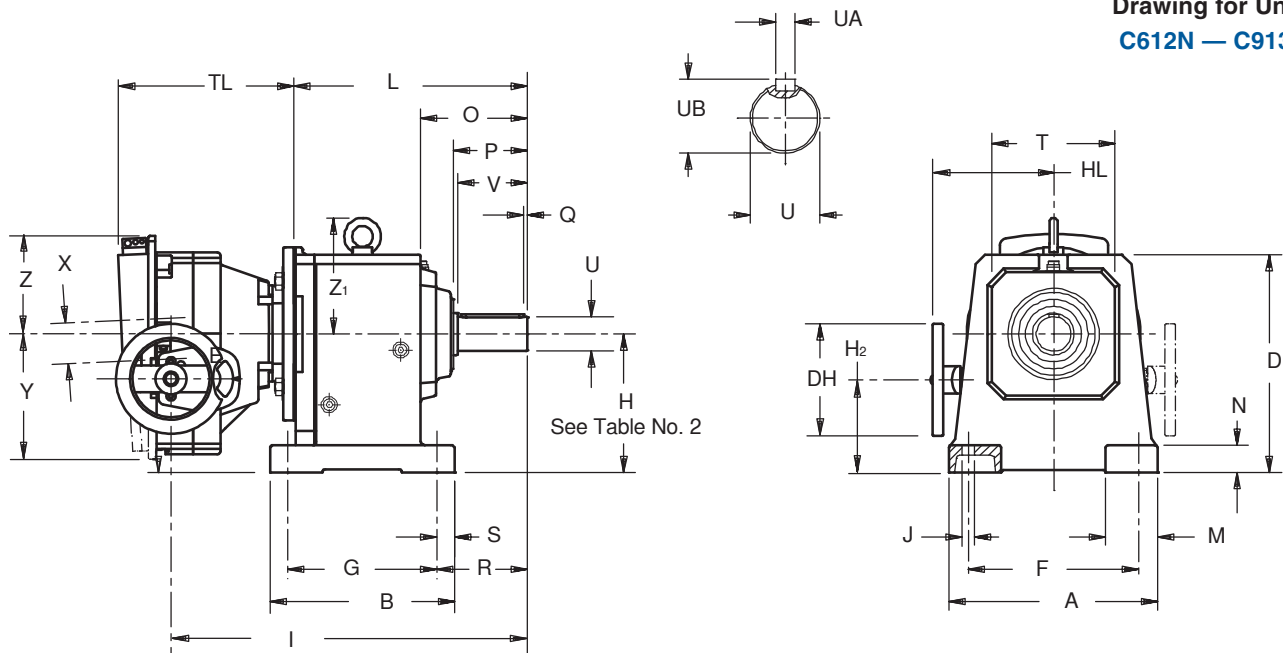

Table No. 5 "C" Series with ComTrac – Foot Mounting Unit Dimensions (Inches) – "N" Housing Style

Base	TD270K050 ⁽²⁾			TD370K140			TD470K180			TD570K180			TD670K210			TD760K210		
	H ₂	I	L	H ₂	I	L	H ₂	I	L	H ₂	I	L	H ₂	I	L	H ₂	I	L
C002	1.65	12.40	6.22	1.18	13.07	6.22	—	—	—	—	—	—	—	—	—	—	—	—
C102	2.44	13.70	7.52	1.97	14.37	7.52	1.42	14.49	7.60	—	—	—	—	—	—	—	—	—
C202	2.95	14.80	8.62	2.48	15.47	8.62	1.93	15.59	8.70	1.18	18.23	8.70	—	—	—	—	—	—
C203⁽¹⁾	1.50	16.50	10.31	—	—	—	—	—	—	—	—	—	—	—	—	—	—	—
C302	3.54	15.55	9.37	3.07	16.22	9.37	2.52	16.34	9.45	1.77	18.98	9.45	1.57	19.29	9.57	—	—	—
C303⁽¹⁾	2.09	17.24	11.06	1.61	17.91	11.06	—	—	—	—	—	—	—	—	—	—	—	—
C402	4.13	17.44	11.24	3.66	18.11	11.26	3.11	18.23	11.34	2.36	20.87	11.34	2.17	21.18	11.46	—	—	—
C403	4.13	19.13	12.95	3.66	19.80	12.95	—	—	—	—	—	—	—	—	—	—	—	—
C502	—	—	—	4.65	18.94	12.09	4.09	19.06	12.17	3.35	21.69	12.17	3.15	22.01	12.28	3.15	24.45	12.83
C503	5.12	19.96	13.78	4.65	20.63	13.78	—	—	—	—	—	—	—	—	—	—	—	—
C612⁽¹⁾	—	—	—	—	—	—	5.04	20.00	13.11	4.29	22.64	13.11	4.09	22.95	13.23	4.09	25.35	13.74
C613⁽¹⁾	6.06	20.94	14.76	5.59	21.61	14.76	5.04	22.44	15.55	4.29	25.08	15.55	—	—	—	—	—	—
C712	—	—	—	—	—	—	6.65	22.09	15.20	5.91	24.72	15.20	5.71	25.00	15.28	5.71	27.40	15.79
C713⁽¹⁾	—	—	—	—	—	—	6.65	24.49	17.60	5.91	27.13	17.60	6.46	27.80	18.07	—	—	—
C812	—	—	—	—	—	—	—	—	—	—	—	—	7.87	27.64	17.91	7.87	29.65	18.03
C813	—	—	—	—	—	—	8.82	27.13	20.24	8.07	29.76	20.24	7.87	30.43	20.71	—	—	—
C912	—	—	—	—	—	—	—	—	—	—	—	—	—	—	—	9.84	32.68	21.06
C913	—	—	—	—	—	—	—	—	—	—	—	—	9.84	32.28	22.56	9.84	35.94	24.33

⁽¹⁾ See Table No. 2. These sizes are not coaxial. H=Output Height, H₁=Input Height.

⁽²⁾ Also **TD270FK140** for a NEMA 143TC frame motor.

Table No. 6 "C" Series with ComTrac – Approximate Weight (lbs.)

Part Number	C002	C102	C202	C203	C302	C303	C402	C403	C502	C503	C612	C613	C712	C713	C812	C813	C912	C913
TD270K050⁽²⁾	51	62	71	78	82	89	104	111	128	144	—	148	—	—	—	—	—	—
TD370K140	69	80	89	—	100	107	122	129	146	162	—	210	—	—	—	—	—	—
TD470K180	—	88	97	—	108	—	130	—	154	—	174	218	258	280	—	401	—	—
TD570K180	—	—	126	—	137	—	159	—	183	—	203	247	287	309	—	430	—	—
TD670K210	—	—	—	—	179	—	201	—	225	—	245	—	329	351	452	472	—	808
TD760K210	—	—	—	—	—	—	—	—	289	—	309	—	393	—	516	—	790	872

⁽²⁾ Also **TD270FK140** for a NEMA 143TC frame motor.

Part No. Example

Foot Mounting with ComTrac, 56C Input, .75 HP motor
C302N0620 TD270K050-075

The STÖBER Difference
...equals VALUE for you



3 Rings

To get competent,
“one-stop” shopping!

STANDARD
3-DAY
DELIVERY



3 WAY After Sale Service

5 Day Factory Service
Field Service
Training Support

2 YEAR WARRANTY
TROUBLE
Few Rotating Parts
Fit Standard NEMA C-face Motor

Additional Product Offering

- MGS® Speed Reducers
- Food and Beverage Duty Speed Reducers
- Poultry Duty Speed Reducers
- ServoFit® Precision Planetary Gearheads
- ServoFit® Modular System Gearheads



"F" Series – Offset Helical MGS® Adjustable Speed Drives

Performance Specifications:

- Horsepower ratings — from 1/2 to 7 1/2
- Output speeds — available from 528 to .6 RPM
- Speed range — 5:1 to 7:1
- Output torques — up to 9,744 in.lbs.
- NEMA frames — from 56C to 215TC

STÖBER's versatility continues with MGS Reducers and ComTrac Adjustable Speed Drives when using the Offset Helical Series.

Compact size and flexibility make these gear drives a popular choice for applications that require high performance, efficiency, and durability.

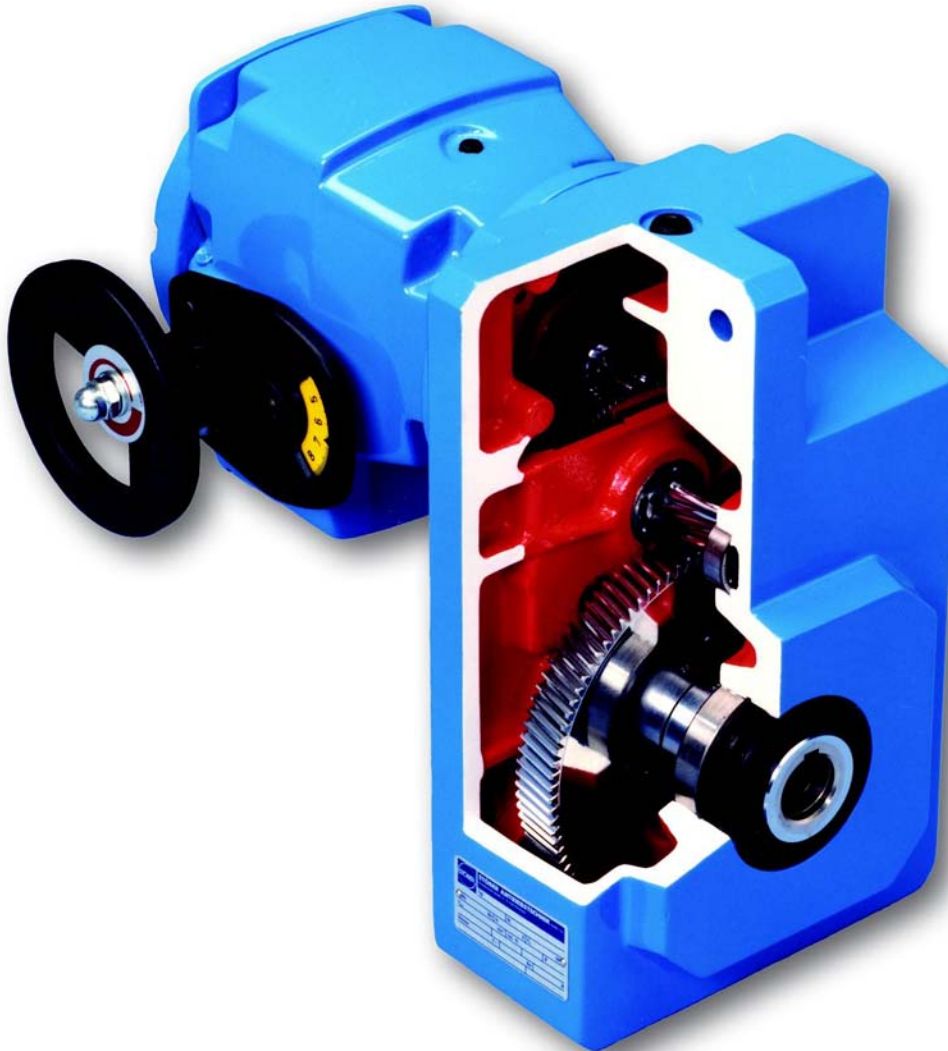

Table No. 1 "F" Series – Output Diameter Options

Base Module	Stainless Bushing Bores Sizes — inches												Hollow			Shaft		
	3/4	1	1 3/16	1 1/4	1 3/8	1 7/16	1 1/2	1 5/8	1 11/16	1 3/4	1 7/8	1 15/16	2	Standard	Stainless	Metric ⁽¹⁾	Standard	Metric ⁽¹⁾
F102	x	—	—	—	—	—	—	—	—	—	—	—	—	.750	—	20	1.000	25
F202/F203	—	x	x	—	—	—	—	—	—	—	—	—	—	1.000	1.000	25	1.250	30
F302/F303	—	x	x	x	x	x	x	—	—	—	—	—	—	1.250	1.250	30	1.375	35
F402/F403	—	x	x	x	x	x	x	—	—	—	—	—	—	1.500	—	40	1.625	40
F602/F603	—	—	x	—	—	x	x	x	x	x	x	x	x	2.000	—	50	2.125	50

⁽¹⁾ Contact STÖBER Drives for availability.



"F" Series – MGS Adjustable Speed Drive Selection Data



Speed Range		Part Number	Maximum		Transition ⁽²⁾		Minimum	
Output RPM ⁽¹⁾			RPM	Torque in.lbs.	RPM	Torque in.lbs.	RPM	Torque in.lbs.
Max.	Min.							

.50 HP, 1750 RPM Motor

528	75	F102_0043	TD270K 050-050	528	48	75	278	75	278
486	69	F202_0047	TD270K 050-050	486	53	69	302	69	302
352	50	F102_0065	TD270K 050-050	352	73	50	416	50	416
318	45	F102_0072	TD270K 050-050	318	81	45	461	45	461
254	36	F102_0089	TD270K 050-050	254	101	36	577	36	577
253	36	F202_0090	TD270K 050-050	253	101	36	580	36	580
208	30	F102_0110	TD270K 050-050	208	123	30	704	30	704
167	24	F102_0135	TD270K 050-050	167	153	24	876	24	876
123	18	F102_0185	TD270K 050-050	123	208	21	1,063	18	1,063
99	14	F102_0230	TD270K 050-050	99	260	23	1,063	14	1,063
81	12	F102_0280	TD270K 050-050	81	317	24	1,063	12	1,063
65	9.3	F102_0350	TD270K 050-050	65	394	25	1,063	9.3	1,063
49	7.0	F102_0460	TD270K 050-050	49	523	25	1,063	7.0	1,063
48	6.9	F202_0470	TD270K 050-050	48	529	11	2,126	6.9	2,126
41	5.8	F102_0560	TD270K 050-050	41	630	25	1,063	5.8	1,063
40	5.8	F302_0560	TD270K 050-050	40	636	5.9	3,543	5.8	3,543
40	5.7	F202_0570	TD270K 050-050	40	638	12	2,126	5.7	2,126
32	4.6	F102_0700	TD270K 050-050	32	788	25	1,063	4.6	1,063
32	4.6	F202_0700	TD270K 050-050	32	789	12	2,126	4.6	2,126
24	3.5	F202_0940	TD270K 050-050	24	1,056	13	2,126	3.5	2,126
24	3.5	F402_0930	TD270K 050-050	24	1,050	3.5	6,015	3.5	6,015
20	2.9	F302_1130	TD270K 050-050	20	1,270	7.4	3,543	2.9	3,543
20	2.9	F402_1120	TD270K 050-050	20	1,264	3.6	6,201	2.9	6,201
16	2.3	F402_1400	TD270K 050-050	16	1,573	3.9	6,201	2.3	6,201
12	1.8	F303_1820	TD270K 050-050	12	2,024	7.5	3,543	1.8	3,543
13	1.8	F403_1820	TD270K 050-050	13	2,013	4.1	6,201	1.8	6,201
13	1.8	F603_1810	TD270K 050-050	13	2,004	2.3	9,744	1.8	9,744
11	1.5	F403_2160	TD270K 050-050	11	2,401	4.2	6,201	1.5	6,201
11	1.5	F603_2150	TD270K 050-050	11	2,390	2.4	9,744	1.5	9,744
10	1.5	F303_2180	TD270K 050-050	10	2,423	7.4	3,543	1.5	3,543
8	1.2	F603_2690	TD270K 050-050	8	2,987	2.6	9,744	1.2	9,744
8	1.2	F303_2720	TD270K 050-050	8	3,018	7.3	3,543	1.2	3,543
8	1.2	F403_2710	TD270K 050-050	8	3,005	4.3	6,201	1.2	6,201
6	0.9	F403_3610	TD270K 050-050	6	4,003	4.3	6,201	0.9	6,201
6	0.9	F603_3610	TD270K 050-050	6	4,003	2.7	9,744	0.9	9,744
5	0.7	F403_4340	TD270K 050-050	5	4,815	4.2	6,201	0.7	6,201
5	0.7	F603_4340	TD270K 050-050	5	4,812	2.7	9,744	0.7	9,744
4	0.6	F603_5400	TD270K 050-050	4	5,994	2.7	9,744	0.6	9,744

.75 HP, 1750 RPM Motor

Continued next page

528	75	F102_0043	TD270K 050-075	528	72	131	278	75	278
486	69	F202_0047	TD270K 050-075	486	78	120	302	69	302
352	50	F102_0065	TD270K 050-075	352	108	87	416	50	416
318	45	F102_0072	TD270K 050-075	318	120	79	461	45	461
254	36	F102_0089	TD270K 050-075	254	150	63	577	36	577

¹⁾ Speed tolerance at rated load is ±3%. At less than rated load, minimum speed may increase 5%.

²⁾ The ComTrac drive operates at constant horsepower above transition values and at constant torque below transition values. Note shaded area. Engineering advances may cause slight changes to the information shown.

Housing Styles

F — Round Flange

G — Tapped Holes

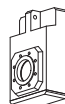

Housing Style "F" is available as Hollow (A) or Solid (V) Output.

See page 78 for mounting positions.

Output Shaft Diameter and
Hollow Output (inches)

See Page 43 for other options.

Base Module	Output Shaft	Hollow Output
F102	1.0000	.7500
F202/F203	1.2500	1.0000
F302/F303	1.3750	1.2500
F402/F403	1.6250	1.5000
F602/F603	2.1250	2.0000



"F" Series – MGS Adjustable Speed Drive Selection Data



Speed Range Output RPM ⁽¹⁾		Part Number	Maximum		Transition ⁽²⁾		Minimum	
			RPM	Torque in.lbs.	RPM	Torque in.lbs.	RPM	Torque in.lbs.
Max.	Min.							

.75 HP, 1750 RPM Motor

Continued next page

253	36	F202_0090	TD270K 050-075	253	151	63	580	36	580
208	30	F102_0110	TD270K 050-075	208	183	52	704	30	704
167	24	F102_0135	TD270K 050-075	167	227	41	876	24	876
123	18	F102_0185	TD270K 050-075	123	309	35	1,063	18	1,063
99	14	F102_0230	TD270K 050-075	99	386	37	1,063	14	1,063
81	12	F102_0280	TD270K 050-075	81	471	37	1,063	12	1,063
65	9.3	F102_0350	TD270K 050-075	65	586	38	1,063	9.3	1,063
64	9.2	F202_0350	TD270K 050-075	64	593	17	2,126	9.2	2,126
49	7.0	F102_0460	TD270K 050-075	49	776	37	1,063	7.0	1,063
48	6.9	F202_0470	TD270K 050-075	48	786	18	2,126	6.9	2,126
41	5.8	F102_0560	TD270K 050-075	41	936	36	1,063	5.8	1,063
40	5.8	F302_0560	TD270K 050-075	40	944	10	3,543	5.8	3,543
40	5.7	F202_0570	TD270K 050-075	40	948	19	2,126	5.7	2,126
32	4.6	F202_0700	TD270K 050-075	32	1,172	19	2,126	4.6	2,126
32	4.6	F302_0700	TD270K 050-075	32	1,176	11	3,543	4.6	3,543
24	3.5	F202_0940	TD270K 050-075	24	1,568	19	2,126	3.5	2,126
24	3.5	F302_0940	TD270K 050-075	24	1,565	11	3,543	3.5	3,543
24	3.5	F402_0930	TD270K 050-075	24	1,560	6.0	6,015	3.5	6,015
20	2.9	F302_1130	TD270K 050-075	20	1,886	11	3,543	2.9	3,543
20	2.9	F402_1120	TD270K 050-075	20	1,877	6.1	6,201	2.9	6,201
16	2.3	F402_1400	TD270K 050-075	16	2,336	6.3	6,201	2.3	6,201
12	1.8	F303_1820	TD270K 050-075	12	3,006	11	3,543	1.8	3,543
13	1.8	F403_1820	TD270K 050-075	13	2,990	6.3	6,201	1.8	6,201
13	1.8	F603_1810	TD270K 050-075	13	2,976	3.8	9,744	1.8	9,744
11	1.5	F403_2160	TD270K 050-075	11	3,565	6.4	6,201	1.5	6,201
11	1.5	F603_2150	TD270K 050-075	11	3,549	3.9	9,744	1.5	9,744
8.4	1.2	F603_2690	TD270K 050-075	8.4	4,436	4.0	9,744	1.2	9,744
8.4	1.2	F403_2710	TD270K 050-075	8.4	4,462	6.3	6,201	1.2	6,201
6.3	0.9	F403_3610	TD270K 050-075	6.3	5,945	6.1	6,201	0.9	6,201
6.3	0.9	F603_3610	TD270K 050-075	6.3	5,945	4.0	9,744	0.9	9,744
5.2	0.7	F603_4340	TD270K 050-075	5.2	7,147	4.0	9,744	0.7	9,744
4.2	0.6	F603_5400	TD270K 050-075	4.2	8,902	3.9	9,744	0.6	9,744
528	75	F102_0043	TD270K 140-100	528	98	190	278	75	278
486	69	F202_0047	TD270K 140-100	486	107	175	302	69	302
352	50	F102_0065	TD270K 140-100	352	147	127	416	50	416
318	45	F102_0072	TD270K 140-100	318	163	115	461	45	461
254	36	F102_0089	TD270K 140-100	254	204	92	577	36	577
253	36	F202_0090	TD270K 140-100	253	205	91	580	36	580
208	30	F102_0110	TD270K 140-100	208	249	75	704	30	704
167	24	F102_0135	TD270K 140-100	167	310	60	876	24	876
123	18	F102_0185	TD270K 140-100	123	421	50	1,063	18	1,063
122	17	F202_0185	TD270K 140-100	122	425	44	1,202	17	1,202
99	14	F102_0230	TD270K 140-100	99	526	51	1,063	14	1,063
97	14	F202_0230	TD270K 140-100	97	534	35	1,510	14	1,510
81	12	F102_0280	TD270K 140-100	81	642	51	1,063	12	1,063
81	12	F202_0280	TD270K 140-100	81	641	29	1,812	12	1,812

Part No. Explanation

Selection Procedure:

- Determine the MGS/ComTrac combination according to the Input HP of the application and the Output RPM nearest the required **maximum** speed.
- Verify that the output torque will sufficiently meet the application requirements.
- Complete the Part No. per the example by adding "A" or "V" for the Output Style and the Housing Style letter ("B", "F", or "G") as required. "V" output is only available with the "F" housing style.

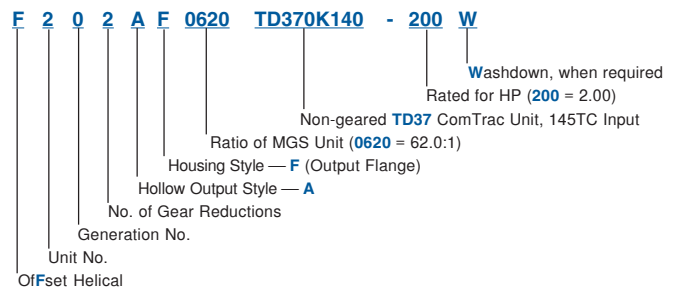



"F" Series – MGS Adjustable Speed Drive Selection Data



Speed Range		Part Number		Maximum		Transition ⁽²⁾		Minimum	
Output RPM ⁽¹⁾				RPM	Torque in.lbs.	RPM	Torque in.lbs.	RPM	Torque in.lbs.
Max.	Min.								
.75 HP, 1750 RPM Motor									
Continued									
65	9.3	F102_0350	TD270K 140-100	65	799	51	1,063	9.3	1,063
64	9.2	F202_0350	TD270K 140-100	64	808	25	2,126	9.2	2,126
49	7.0	F102_0460	TD270K 140-100	49	1,058	49	1,063	7.0	1,063
48	6.9	F202_0470	TD270K 140-100	48	1,072	26	2,126	6.9	2,126
48	6.9	F302_0470	TD270K 140-100	48	1,075	17	3,041	6.9	3,041
40	5.8	F302_0560	TD270K 140-100	40	1,287	15	3,543	5.8	3,543
40	5.7	F202_0570	TD270K 140-100	40	1,293	26	2,126	5.7	2,126
32	4.6	F202_0700	TD270K 140-100	32	1,598	25	2,126	4.6	2,126
32	4.6	F302_0700	TD270K 140-100	32	1,603	15	3,543	4.6	3,543
24	3.5	F302_0940	TD270K 140-100	24	2,134	15	3,543	3.5	3,543
24	3.5	F402_0930	TD270K 140-100	24	2,127	8.8	6,015	3.5	6,015
20	2.9	F302_1130	TD270K 140-100	20	2,572	15	3,543	2.9	3,543
20	2.9	F402_1120	TD270K 140-100	20	2,559	8.7	6,201	2.9	6,201
16	2.3	F402_1400	TD270K 140-100	16	3,185	8.8	6,201	2.3	6,201
16	2.3	F602_1400	TD270K 140-100	16	3,185	5.9	9,006	2.3	9,006
13	1.8	F403_1820	TD270K 140-100	13	4,077	8.6	6,201	1.8	6,201
13	1.8	F603_1810	TD270K 140-100	13	4,057	5.4	9,744	1.8	9,744
11	1.5	F403_2160	TD270K 140-100	11	4,861	8.5	6,201	1.5	6,201
11	1.5	F603_2150	TD270K 140-100	11	4,838	5.5	9,744	1.5	9,744
8.4	1.2	F603_2690	TD270K 140-100	8.4	6,048	5.5	9,744	1.2	9,744
8.4	1.2	F403_2710	TD270K 140-100	8.4	6,084	8.3	6,201	1.2	6,201
6.3	0.9	F603_3610	TD270K 140-100	6.3	8,105	5.4	9,744	0.9	9,744
5.2	0.7	F603_4340	TD270K 140-100	5.2	9,744	5.2	9,744	0.7	9,744

1.0 HP, 1750 RPM Motor

Continued next page

508	102	F102_0043	TD370K 140-150	508	152	194	407	102	407
471	94	F302_0046	TD370K 140-150	471	163	180	439	94	439
467	93	F202_0047	TD370K 140-150	467	165	179	442	93	442
394	79	F202_0056	TD370K 140-150	394	195	151	525	79	525
339	68	F102_0065	TD370K 140-150	339	227	129	611	68	611
306	61	F102_0072	TD370K 140-150	306	252	117	676	61	676
244	49	F102_0089	TD370K 140-150	244	315	93	846	49	846
243	49	F202_0090	TD370K 140-150	243	317	93	851	49	851
200	40	F102_0110	TD370K 140-150	200	384	83	956	40	956
202	40	F202_0110	TD370K 140-150	202	380	77	1,021	40	1,021
161	32	F102_0135	TD370K 140-150	161	478	85	950	32	950
161	32	F202_0135	TD370K 140-150	161	479	61	1,288	32	1,288
119	24	F102_0185	TD370K 140-150	119	649	84	952	24	952
117	23	F202_0185	TD370K 140-150	117	656	45	1,763	23	1,763
117	23	F302_0190	TD370K 140-150	117	660	45	1,774	23	1,774
95	19	F102_0230	TD370K 140-150	95	812	82	962	19	962
93	19	F202_0230	TD370K 140-150	93	824	37	2,126	19	2,126
93	19	F302_0240	TD370K 140-150	93	827	36	2,223	19	2,223
78	16	F202_0280	TD370K 140-150	78	989	38	2,126	16	2,126
77	15	F302_0280	TD370K 140-150	77	993	30	2,668	15	2,668

¹⁾ Speed tolerance at rated load is ±3%. At less than rated load, minimum speed may increase 5%.

²⁾ The ComTrac drive operates at constant horsepower above transition values and at constant torque below transition values. Note shaded area. Engineering advances may cause slight changes to the information shown.

Housing Styles
F — Round Flange **G** — Tapped Holes

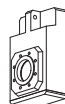

Housing Style "F" is available as Hollow (A) or Solid (V) Output.
 See page 78 for mounting positions.

Output Shaft Diameter and
Hollow Output (inches)

See Page 43 for other options.

Base Module	Output Shaft	Hollow Output
F102	1.0000	.7500
F202/F203	1.2500	1.0000
F302/F303	1.3750	1.2500
F402/F403	1.6250	1.5000
F602/F603	2.1250	2.0000



"F" Series – MGS Adjustable Speed Drive Selection Data



Speed Range Output RPM ⁽¹⁾		Part Number	Maximum		Transition ⁽²⁾		Minimum	
			RPM	Torque in.lbs.	RPM	Torque in.lbs.	RPM	Torque in.lbs.
Max.	Min.							

1.0 HP, 1750 RPM Motor Continued

62	12	F202_0350	TD370K 140-150	62	1,247	38	2,126	12	2,126
62	12	F302_0350	TD370K 140-150	62	1,233	24	3,311	12	3,311
46	9.3	F202_0470	TD370K 140-150	46	1,655	37	2,126	9.3	2,126
46	9.3	F302_0470	TD370K 140-150	46	1,660	23	3,543	9.3	3,543
39	7.7	F302_0560	TD370K 140-150	39	1,987	23	3,543	7.7	3,543
39	7.8	F402_0560	TD370K 140-150	39	1,969	15	5,290	7.8	5,290
39	7.7	F202_0570	TD370K 140-150	39	1,996	37	2,126	7.7	2,126
31	6.2	F302_0700	TD370K 140-150	31	2,475	23	3,543	6.2	3,543
31	6.2	F402_0700	TD370K 140-150	31	2,465	13	6,201	6.2	6,201
23	4.7	F402_0930	TD370K 140-150	23	3,283	13	6,201	4.7	6,201
23	4.7	F602_0930	TD370K 140-150	23	3,283	9.0	8,821	4.7	8,821
23	4.7	F302_0940	TD370K 140-150	23	3,294	22	3,543	4.7	3,543
19	3.9	F402_1120	TD370K 140-150	19	3,950	13	6,201	3.9	6,201
19	3.9	F602_1120	TD370K 140-150	19	3,947	8.2	9,744	3.9	9,744
16	3.1	F602_1400	TD370K 140-150	16	4,916	8.3	9,744	3.1	9,744
12	2.4	F603_1810	TD370K 140-150	12	6,263	8.2	9,744	2.4	9,744
10	2.0	F603_2150	TD370K 140-150	10	7,469	8.0	9,744	2.0	9,744
8.1	1.6	F603_2690	TD370K 140-150	8.1	9,337	7.8	9,744	1.6	9,744

2.0 HP, 1750 RPM Motor Continued next page

508	102	F102_0043	TD370K 140-200	508	207	271	407	102	407
471	94	F302_0046	TD370K 140-200	471	223	251	439	94	439
467	93	F202_0047	TD370K 140-200	467	225	249	442	93	442
394	79	F202_0056	TD370K 140-200	394	267	210	525	79	525
339	68	F102_0065	TD370K 140-200	339	310	180	611	68	611
306	61	F102_0072	TD370K 140-200	306	344	163	676	61	676
305	61	F202_0072	TD370K 140-200	305	344	163	677	61	677
244	49	F102_0089	TD370K 140-200	244	430	136	812	49	812
243	49	F202_0090	TD370K 140-200	243	432	129	851	49	851
200	40	F102_0110	TD370K 140-200	200	524	136	813	40	813
202	40	F202_0110	TD370K 140-200	202	519	108	1,021	40	1,021
161	32	F102_0135	TD370K 140-200	161	653	132	821	32	821
161	32	F202_0135	TD370K 140-200	161	654	86	1,288	32	1,288
117	23	F202_0185	TD370K 140-200	117	896	63	1,763	23	1,763
117	23	F302_0190	TD370K 140-200	117	902	62	1,774	23	1,774
93	19	F202_0230	TD370K 140-200	93	1,125	52	2,126	19	2,126
93	19	F302_0240	TD370K 140-200	93	1,129	50	2,223	19	2,223
78	16	F202_0280	TD370K 140-200	78	1,350	52	2,126	16	2,126
77	15	F302_0280	TD370K 140-200	77	1,356	41	2,668	15	2,668
62	12	F202_0350	TD370K 140-200	62	1,703	51	2,126	12	2,126
62	12	F302_0350	TD370K 140-200	62	1,682	33	3,311	12	3,311
46	9.3	F302_0470	TD370K 140-200	46	2,266	31	3,543	9.3	3,543
47	9.3	F402_0470	TD370K 140-200	47	2,254	25	4,437	9.3	4,437
39	7.7	F302_0560	TD370K 140-200	39	2,713	31	3,543	7.7	3,543
39	7.8	F402_0560	TD370K 140-200	39	2,688	21	5,290	7.8	5,290

Part No. Explanation

Selection Procedure:

- Determine the MGS/ComTrac combination according to the Input HP of the application and the Output RPM nearest the required **maximum** speed.
- Verify that the output torque will sufficiently meet the application requirements.
- Complete the Part No. per the example by adding "A" or "V" for the Output Style and the Housing Style letter ("B", "F", or "G") as required. "V" output is only available with the "F" housing style.

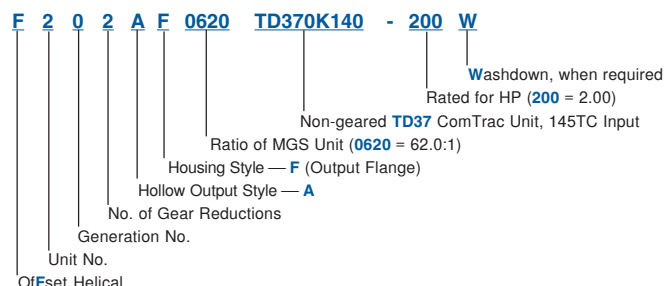



"F" Series – MGS Adjustable Speed Drive Selection Data



Speed Range		Part Number	Maximum		Transition ⁽²⁾		Minimum	
Output RPM ⁽¹⁾			RPM	Torque in.lbs.	RPM	Torque in.lbs.	RPM	Torque in.lbs.
Max.	Min.							

2.0 HP, 1750 RPM Motor Continued

31	6.2	F302_0700	TD370K 140-200	31	3,379	30	3,543	6.2	3,543
31	6.2	F402_0700	TD370K 140-200	31	3,364	18	6,201	6.2	6,201
31	6.3	F602_0700	TD370K 140-200	31	3,344	17	6,582	6.3	6,582
23	4.7	F402_0930	TD370K 140-200	23	4,482	18	6,201	4.7	6,201
23	4.7	F602_0930	TD370K 140-200	23	4,482	12	8,821	4.7	8,821
19	3.9	F402_1120	TD370K 140-200	19	5,391	17	6,201	3.9	6,201
19	3.9	F602_1120	TD370K 140-200	19	5,388	11	9,744	3.9	9,744
16	3.1	F602_1400	TD370K 140-200	16	6,711	11	9,744	3.1	9,744
12	2.4	F603_1810	TD370K 140-200	12	8,550	11	9,744	2.4	9,744

3.0 HP, 1750 RPM Motor

471	94	F302_0046	TD470K 180-300	471	344	204	798	94	798
467	93	F202_0047	TD470K 180-300	467	347	203	804	93	804
394	79	F202_0056	TD470K 180-300	394	412	171	954	79	954
382	76	F302_0057	TD470K 180-300	382	424	166	983	76	983
376	75	F402_0058	TD470K 180-300	376	431	163	999	75	999
305	61	F202_0072	TD470K 180-300	305	531	132	1,232	61	1,232
243	49	F202_0090	TD470K 180-300	243	668	105	1,548	49	1,548
243	49	F302_0090	TD470K 180-300	243	666	106	1,544	49	1,544
202	40	F202_0110	TD470K 180-300	202	801	88	1,856	40	1,856
203	41	F302_0110	TD470K 180-300	203	800	88	1,853	41	1,853
161	32	F202_0135	TD470K 180-300	161	1,010	89	1,860	32	1,860
163	33	F302_0135	TD470K 180-300	163	992	71	2,300	33	2,300
117	23	F202_0185	TD470K 180-300	117	1,383	90	1,853	23	1,853
117	23	F402_0185	TD470K 180-300	117	1,381	51	3,200	23	3,200
117	23	F302_0190	TD470K 180-300	117	1,392	51	3,226	23	3,226
93	19	F202_0230	TD470K 180-300	93	1,738	88	1,872	19	1,872
94	19	F402_0230	TD470K 180-300	94	1,721	41	3,989	19	3,989
93	19	F302_0240	TD470K 180-300	93	1,744	46	3,543	19	3,543
77	15	F302_0280	TD470K 180-300	77	2,093	47	3,543	15	3,543
78	16	F402_0280	TD470K 180-300	78	2,075	34	4,809	16	4,809
62	12	F302_0350	TD470K 180-300	62	2,598	47	3,543	12	3,543
62	12	F402_0350	TD470K 180-300	62	2,601	27	6,028	12	6,028
46	9.3	F302_0470	TD470K 180-300	46	3,499	46	3,543	9.3	3,543
47	9.3	F402_0470	TD470K 180-300	47	3,481	27	6,201	9.3	6,201
47	9.4	F602_0470	TD470K 180-300	47	3,464	20	8,028	9.4	8,028
39	7.8	F402_0560	TD470K 180-300	39	4,151	27	6,201	7.8	6,201
39	7.9	F602_0560	TD470K 180-300	39	4,131	17	9,574	7.9	9,574
31	6.2	F402_0700	TD470K 180-300	31	5,195	27	6,201	6.2	6,201
31	6.3	F602_0700	TD470K 180-300	31	5,164	17	9,744	6.3	9,744
23	4.7	F602_0930	TD470K 180-300	23	6,921	17	9,744	4.7	9,744

5.0 HP, 1750 RPM Motor Continued next page

471	94	F302_0046	TD570K 180-500	471	590	235	1,197	94	1,197
467	93	F202_0047	TD570K 180-500	467	594	233	1,206	93	1,206

¹⁾ Speed tolerance at rated load is ±3%. At less than rated load, minimum speed may increase 5%.

²⁾ The ComTrac drive operates at constant horsepower above transition values and at constant torque below transition values. Note shaded area. Engineering advances may cause slight changes to the information shown.

Housing Styles

F — Round Flange G — Tapped Holes

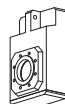

Housing Style "F" is available as Hollow (A) or Solid (V) Output.
See page 78 for mounting positions.

Output Shaft Diameter and
Hollow Output (inches)

See Page 43 for other options.

Base Module	Output Shaft	Hollow Output
F102	1.0000	.7500
F202/F203	1.2500	1.0000
F302/F303	1.3750	1.2500
F402/F403	1.6250	1.5000
F602/F603	2.1250	2.0000



"F" Series – MGS Adjustable Speed Drive Selection Data



Speed Range Output RPM ⁽¹⁾		Part Number	Maximum		Transition ⁽²⁾		Minimum	
			RPM	Torque in.lbs.	RPM	Torque in.lbs.	RPM	Torque in.lbs.
Max.	Min.							

5.0 HP, 1750 RPM Motor

Continued

468	94	F402_0047	TD570K 180-500	468	594	233	1,206	94	1,206
394	79	F202_0056	TD570K 180-500	394	705	197	1,429	79	1,429
382	76	F302_0057	TD570K 180-500	382	726	191	1,474	76	1,474
376	75	F402_0058	TD570K 180-500	376	738	188	1,498	75	1,498
305	61	F202_0072	TD570K 180-500	305	910	201	1,419	61	1,419
305	61	F302_0072	TD570K 180-500	305	911	152	1,849	61	1,849
243	49	F202_0090	TD570K 180-500	243	1,144	199	1,423	49	1,423
243	49	F302_0090	TD570K 180-500	243	1,141	121	2,316	49	2,316
244	49	F402_0090	TD570K 180-500	244	1,140	121	2,315	49	2,315
202	40	F202_0110	TD570K 180-500	202	1,372	195	1,434	40	1,434
203	41	F302_0110	TD570K 180-500	203	1,370	101	2,780	41	2,780
202	40	F402_0110	TD570K 180-500	202	1,375	101	2,790	40	2,790
163	33	F302_0135	TD570K 180-500	163	1,700	93	3,058	33	3,058
161	32	F402_0135	TD570K 180-500	161	1,723	80	3,498	32	3,498
117	23	F402_0185	TD570K 180-500	117	2,364	59	4,800	23	4,800
117	23	F302_0190	TD570K 180-500	117	2,384	93	3,054	23	3,054
94	19	F402_0230	TD570K 180-500	94	2,948	47	5,984	19	5,984
94	19	F602_0230	TD570K 180-500	94	2,955	47	5,999	19	5,999
93	19	F302_0240	TD570K 180-500	93	2,987	90	3,082	19	3,082
78	16	F402_0280	TD570K 180-500	78	3,554	46	6,201	16	6,201
78	16	F602_0280	TD570K 180-500	78	3,554	39	7,214	16	7,214
62	12	F402_0350	TD570K 180-500	62	4,455	46	6,201	12	6,201
62	12	F602_0350	TD570K 180-500	62	4,471	31	9,075	12	9,075
47	9.3	F402_0470	TD570K 180-500	47	5,961	45	6,201	9.3	6,201
47	9.4	F602_0470	TD570K 180-500	47	5,933	29	9,744	9.4	9,744
39	7.9	F602_0560	TD570K 180-500	39	7,075	29	9,744	7.9	9,744
31	6.3	F602_0700	TD570K 180-500	31	8,844	29	9,744	6.3	9,744

7.5 HP, 1750 RPM Motor

481	96	F602_0045	TD670K 210-750	481	858	262	1,601	96	1,601
468	94	F402_0047	TD670K 210-750	468	883	255	1,648	94	1,648
386	77	F602_0057	TD670K 210-750	386	1,071	210	1,998	77	1,998
376	75	F402_0058	TD670K 210-750	376	1,097	205	2,048	75	2,048
304	61	F402_0072	TD670K 210-750	304	1,359	166	2,537	61	2,537
244	49	F402_0090	TD670K 210-750	244	1,695	133	3,164	49	3,164
202	40	F402_0110	TD670K 210-750	202	2,043	110	3,813	40	3,813
161	32	F402_0135	TD670K 210-750	161	2,561	88	4,780	32	4,780
161	32	F602_0135	TD670K 210-750	161	2,569	88	4,794	32	4,794
117	23	F402_0185	TD670K 210-750	117	3,515	80	5,302	23	5,302
118	24	F602_0185	TD670K 210-750	118	3,496	64	6,525	24	6,525
94	19	F402_0230	TD670K 210-750	94	4,382	79	5,325	19	5,325
94	19	F602_0230	TD670K 210-750	94	4,393	51	8,198	19	8,198
78	16	F402_0280	TD670K 210-750	78	5,282	77	5,368	16	5,368
78	16	F602_0280	TD670K 210-750	78	5,282	43	9,744	16	9,744
62	12	F602_0350	TD670K 210-750	62	6,645	44	9,744	12	9,744
47	9.4	F602_0470	TD670K 210-750	47	8,818	43	9,744	9.4	9,744

Part No. Explanation

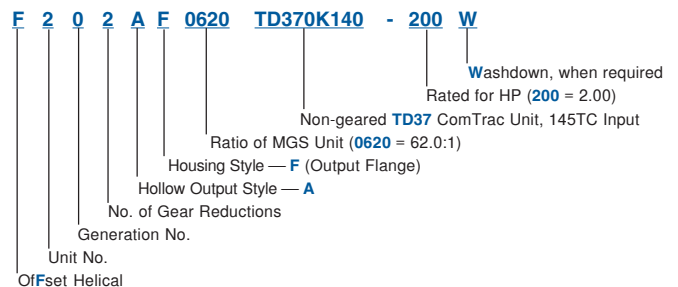

Selection Procedure:

- Determine the MGS/ComTrac combination according to the Input HP of the application and the Output RPM nearest the required **maximum** speed.
- Verify that the output torque will sufficiently meet the application requirements.
- Complete the Part No. per the example by adding "A" or "V" for the Output Style and the Housing Style letter ("B", "F", or "G") as required. "V" output is only available with the "F" housing style.



"F" Series – MGS® Adjustable Speed Drives Dimensional Data

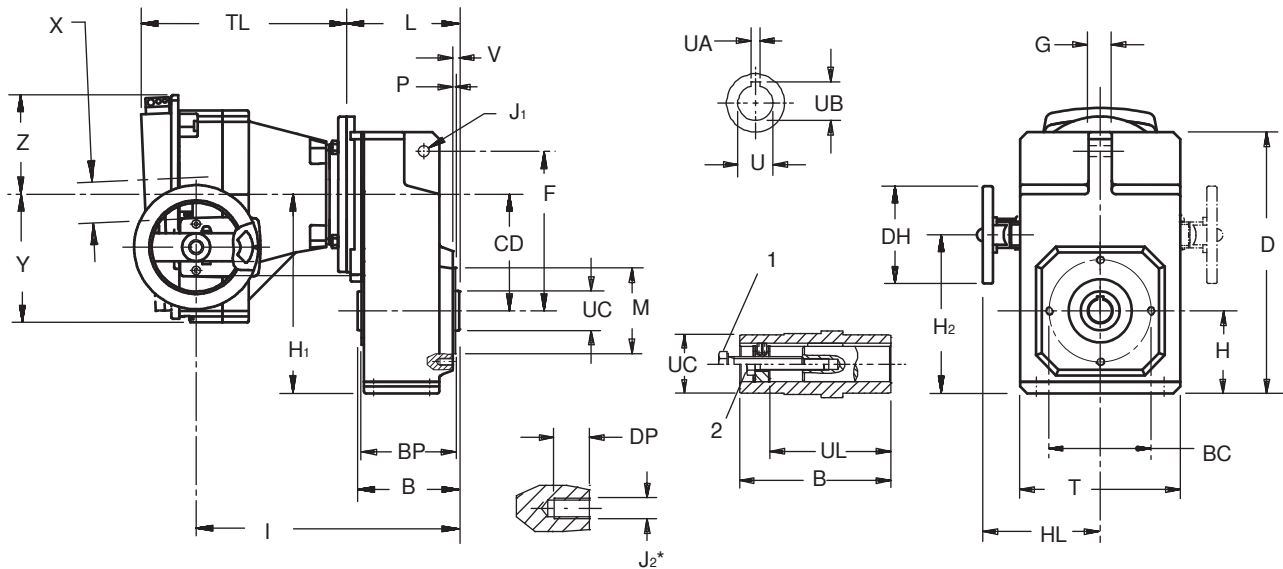

Drawing for Units
F102AG — F603AG

Part No. Example
Basic Unit with ComTrac
F302AG0620 TD270K140

Table No. 1 "F" Series – Tapped Holes Unit Dimensions (Inches) – "G" Housing Style

Base Module	CD	B	D	F	G	H	H ₁	J ₁	J ₂ *	M	Tolerance	P	T	V	BC	BP	DP
F102	4.02	3.74	9.37	5.91	.79	2.91	6.93	.43	M8	2.756	+0.007/-0.0005	.10	5.71	.26	3.35	3.43	.51
F202/F203	5.16	4.53	11.77	7.13	.87	3.66	8.82	.43	M8	3.740	+0.007/-0.0005	.12	7.09	.31	4.53	4.13	.51
F302/F303	5.89	5.12	13.23	8.07	1.18	4.17	10.06	.55	M10	4.331	+0.007/-0.0005	.14	8.11	.33	5.12	4.72	.63
F402/F403	6.65 ¹⁾	5.71	14.57	8.98	1.18	4.57	11.22	.55	M10	4.331	+0.007/-0.0005	.14	9.06	.33	5.12	5.31	.63
F602/F603	7.72	7.09	17.64	10.63	1.38	5.39	13.11	.87	M10	5.118	+0.008/-0.0006	.14	10.43	.41	6.50	6.54	.63

* F602 and F603 has 8 tapped holes instead of 4 as shown on drawing.

¹⁾ "CD" is 5.20 for a F403 with TD27.

Table No. 2 "F" Series Bore Dimensions (Inches)

Base Module	U	Tolerance	UA	UB	UC	UL	1
F102	.750	+0.008/-0.0000	.187	.84	1.38	2.87	3/8-16
F202	1.000	+0.008/-0.0000	.250	1.12	1.77	3.62	1/2-13
F302	1.250	+0.010/-0.0000	.250	1.37	1.97	4.06	1/2-13
F402/F403	1.500	+0.010/-0.0000	.375	1.67	2.17	4.49	3/4-10
F602/F603	2.000	+0.012/-0.0000	.500	2.23	2.76	5.63	3/4-10

1. Removal Bolt – not supplied.

2. Mounting Bolt – must be smaller than removal bolt.

All weights are approximate.

Table No. 3 "F" Series – Unit Dimensions (Inches)

ComTrac Part No.	NEMA C-Flange	DH	HL	TL	X	Y	Z
TD270K050	56C	4.92	5.67	7.87	2.09	5.55	4.41
TD270K140	143/145TC	4.92	5.67	7.87	2.09	5.55	4.41
TD370K140	143/145TC	4.92	5.91	8.50	2.17	5.67	4.37
TD470K180	182/184TC	6.30	6.81	8.94	2.80	7.20	5.59
TD570K180	182/184TC	7.87	8.31	11.89	3.11	8.11	6.30
TD670K210	213/215TC	7.87	9.17	12.17	3.86	9.02	7.13

Table No. 4 "F" Series – Unit Dimensions (Inches)

Base Module	TD270K050 ⁽²⁾			Wt. lbs.	TD370K140			Wt. lbs.	TD470K180			Wt. lbs.	TD570K180			Wt. lbs.	TD670K210			Wt. lbs.
	H ₂	I	L		H ₂	I	L		H ₂	I	L		H ₂	I	L		H ₂	I	L	
F102	5.35	10.43	4.25	71	4.88	11.10	4.25	89	—	—	—	—	—	—	—	—	—	—	—	
F202	7.24	11.18	5.08	84	6.77	11.85	5.08	102	6.22	11.97	5.08	110	—	—	—	—	—	—	—	
F302	8.48	11.77	5.67	100	8.01	12.52	5.67	118	7.46	12.56	5.67	126	6.20	15.20	5.67	155	—	—	—	
F402	9.65	12.36	6.38	117	9.17	13.03	6.38	135	8.62	13.15	6.38	143	7.87	15.79	6.38	172	7.68	16.10	6.38	214
F403	8.19	14.06	7.87	124	—	—	—	—	—	—	—	—	—	—	—	—	—	—	—	
F602	11.54	13.85	7.48	198	11.06	14.33	7.68	216	10.51	14.45	7.68	224	9.76	17.09	7.68	253	9.57	17.40	7.68	295
F603	11.54	15.35	9.17	210	11.06	16.02	9.17	228	—	—	—	—	—	—	—	—	—	—	—	

⁽²⁾ Also available for a NEMA 143TC frame motor.



"F" Series – MGS® Adjustable Speed Drives

Dimensional Data

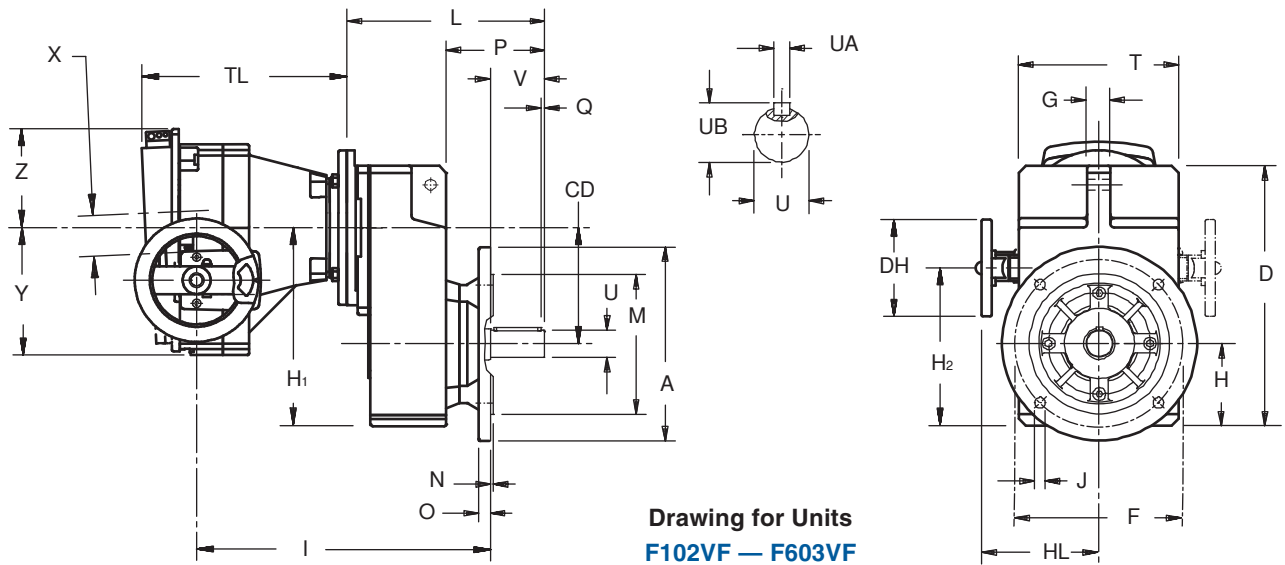

Drawing for Units
F102VF — F603VF

Part No. Example
Basic Unit with ComTrac
F302VF0620 TD270K140

Table No. 1 "F" Series – Round Flange Dimensions (Inches) – "F" Housing Style

Base Module	CD	A	D	F	G	H	H ₁	J	M	Tolerance	N	O	P	Q	T	V
F102	4.02	6.30	9.37	5.12	.79	2.91	6.93	.35	4.331	+0.0008/-0.0006	.14	.39	3.80	.16	5.71	1.97
F202/F203	5.16	7.87	11.77	6.50	.87	3.66	8.82	.43	5.118	+0.0008/-0.0006	.14	.55	4.53	.16	7.09	2.36
F302/F303	5.89	9.84	13.23	8.46	1.18	4.17	10.06	.55	7.087	+0.0008/-0.0006	.16	.59	5.10	.16	8.11	2.76
F402/F403	6.65 ¹⁾	9.84	14.57	8.46	1.18	4.57	11.22	.55	7.087	+0.0008/-0.0006	.16	.59	5.49	.16	9.06	3.15
F602/F603	7.72	11.81	17.64	10.43	1.38	5.39	13.11	.55	9.055	+0.0012/-0.0008	.16	.67	6.44	.20	10.43	3.94

¹⁾ "CD" is 5.20 for a F403 with TD27.

Table No. 2 "F" Series Shaft Dimensions (Inches)

Base Module	U	Tolerance	UA—Key	UB
F102	1.000	+0.0000/-0.0006	1/4 × 1/4 × 1 ⁹ / ₁₆	1.11
F202	1.250	+0.0000/-0.0007	1/4 × 1/4 × 1 ¹⁵ / ₁₆	1.36
F302	1.375	+0.0000/-0.0007	5/16 × 5/16 × 2 ⁹ / ₁₆	1.51
F402/F403	1.625	+0.0000/-0.0007	3/8 × 3/8 × 2 ⁷ / ₈	1.79
F602/F603	2.125	+0.0000/-0.0008	1/2 × 1/2 × 3 ⁵ / ₃₂	2.35

Table No. 3 "F" Series – Unit Dimensions (Inches)

ComTrac Part No.	NEMA C-Flange	DH	HL	TL	X	Y	Z
TD270K050	56C	4.92	5.67	7.87	2.09	5.55	4.41
TD270K140	143/145TC	4.92	5.67	7.87	2.09	5.55	4.41
TD370K140	143/145TC	4.92	5.91	8.50	2.17	5.67	4.37
TD470K180	182/184TC	6.30	6.81	8.94	2.80	7.20	5.59
TD570K180	182/184TC	7.87	8.31	11.89	3.11	8.11	6.30
TD670K210	213/215TC	7.87	9.17	12.17	3.86	9.02	7.13

Table No. 4 "F" Series – Unit Dimensions (Inches)

Base Module	TD270K050 ⁽²⁾			Wt. lbs.	TD370K140			Wt. lbs.	TD470K180			Wt. lbs.	TD570K180			Wt. lbs.	TD670K210			Wt. lbs.
	H ₂	I	L		H ₂	I	L		H ₂	I	L		H ₂	I	L		H ₂	I	L	
F102	5.35	11.46	7.24	71	4.88	12.13	7.24	89	—	—	—	—	—	—	—	—	—	—	—	
F202	7.24	12.44	8.54	84	6.77	13.11	8.54	102	6.22	13.15	8.62	110	—	—	—	—	—	—	—	
F302	8.48	13.11	9.61	100	8.01	13.78	9.61	118	7.46	13.81	9.69	126	6.20	16.45	9.69	155	—	—	—	
F402	9.65	13.82	10.59	117	9.17	14.49	10.59	135	8.62	14.53	10.67	143	7.87	17.17	10.67	172	7.68	17.36	10.79	214
F403	8.19	15.31	12.28	124	—	—	—	—	—	—	—	—	—	—	—	—	—	—	—	
F602	11.54	15.03	12.60	198	11.06	15.75	12.60	216	10.51	15.71	12.68	224	9.76	18.39	12.68	253	9.57	18.58	12.80	295
F603	11.54	15.35	14.29	210	11.06	16.02	14.29	228	—	—	—	—	—	—	—	—	—	—	—	

⁽²⁾ Also available for a NEMA 143TC frame motor.
All weights are approximate.

**Personalized Mailer
Available Free!**

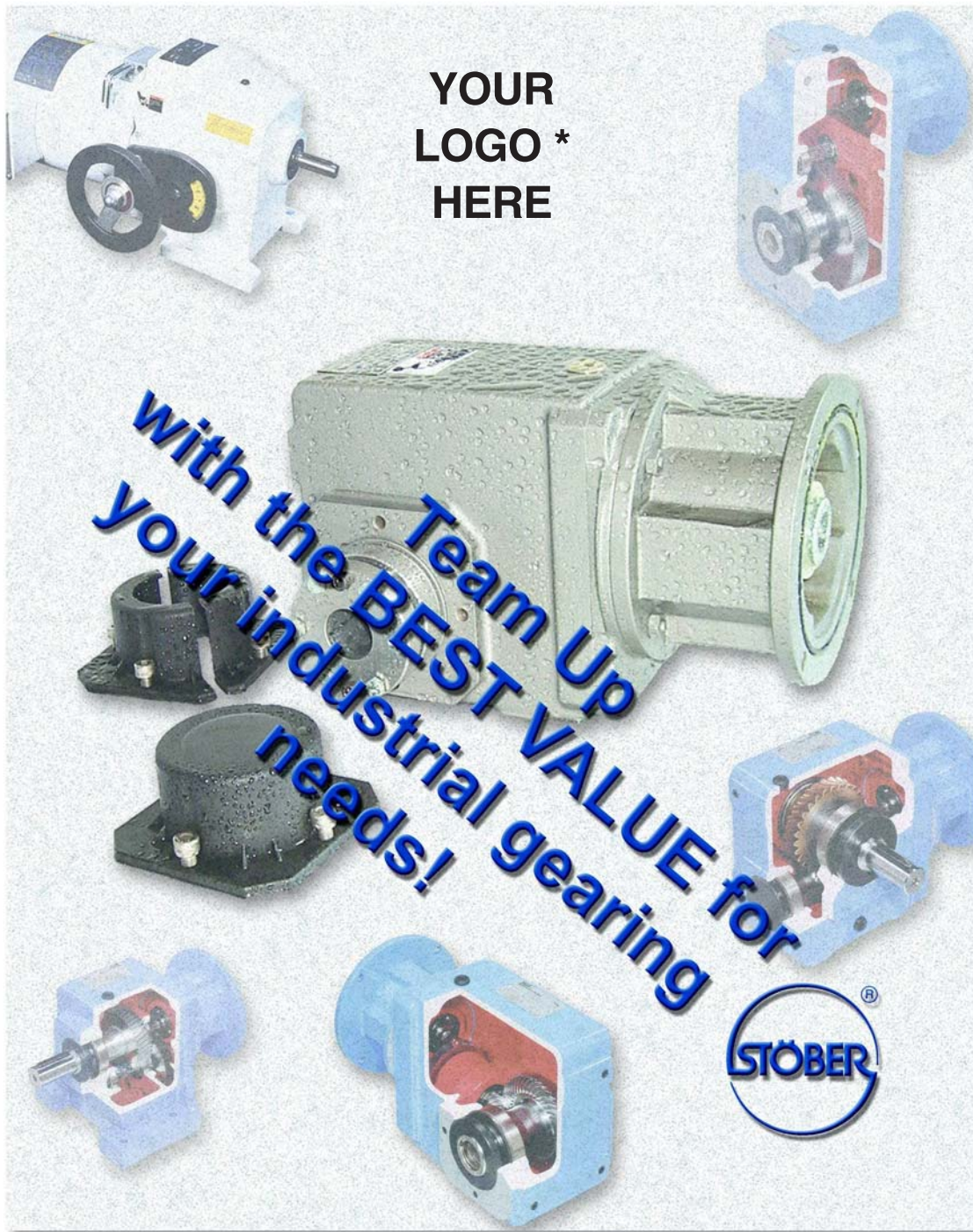

The above mailer provides introductory information on industrial products. The back of this one page mailer describes the performance data for ComTrac and MGS products.

Contact your STÖBER representative for more information or to request a quantity for your mailing. We will imprint them with your logo and send them to you – free!

* Logo should be in a high resolution tif format for best printing results.



"K" Series – Right Angle Helical/Bevel MGS® Adjustable Speed Drives

Performance Specifications:

- Horsepower ratings — from 1/2 to 10
- Output speeds — available from 569 to .9 RPM
- Speed range — 5:1 to 7:1
- Output torques — up to 99,227 in.lbs.
- NEMA frames — from 56C to 215TC

With the many mounting options available, ComTrac Adjustable Speed Drives and MGS Helical/Bevel Speed Reducers offer consistent, higher input-to-output efficiencies and a configurations for almost any application situation. This added efficiency reduces your costs today through smaller gear drive and motor sizing. Tomorrow, you'll benefit through optimum energy savings.

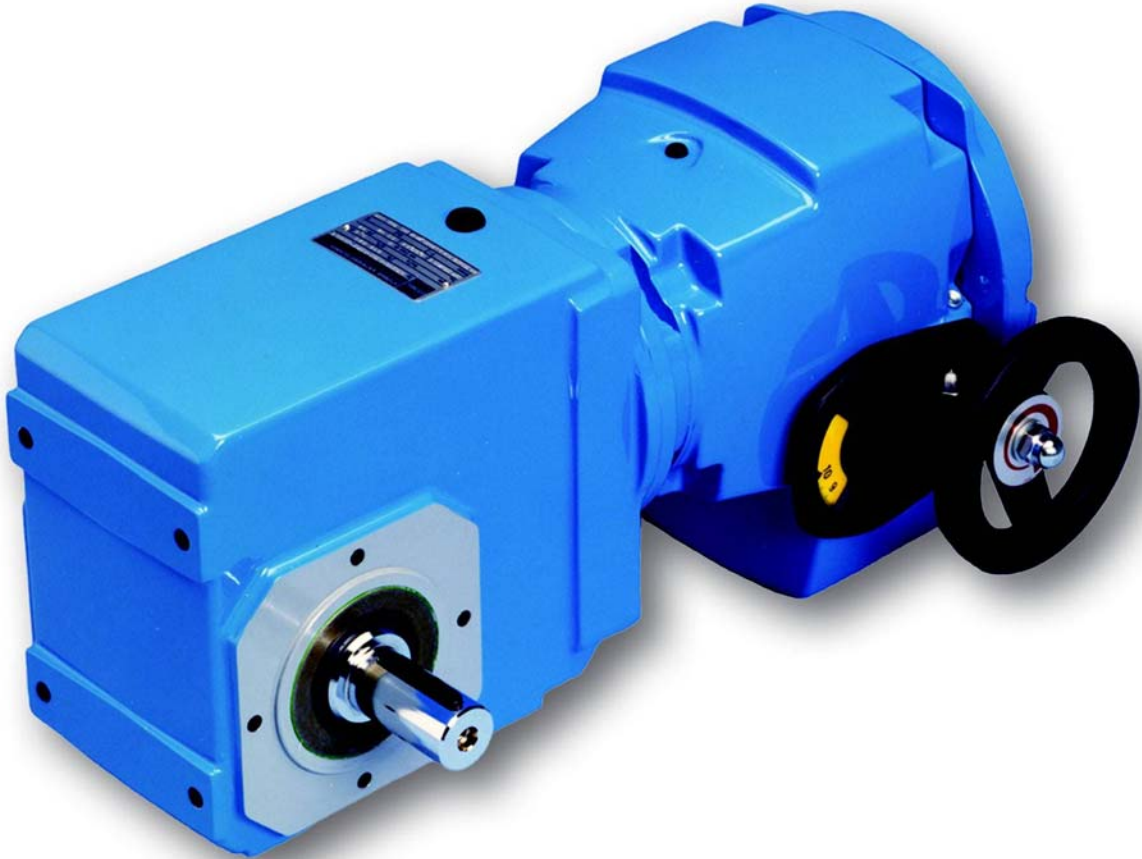

Table No. 1

"K" Series Output Diameters

Base	Hollow		Shaft			Stainless Steel Bushing Bores																			
	inches		mm	inches		mm	inches															mm			
	Std	SS		Std	SS ⁽²⁾		1	1 ³ / ₁₆	1 ¹ / ₄	1 ³ / ₈	1 ⁷ / ₁₆	1 ¹ / ₂	1 ⁵ / ₈	1 ¹¹ / ₁₆	1 ³ / ₄	1 ⁷ / ₈	1 ¹⁵ / ₁₆	2	2 ³ / ₁₆	2 ³ / ₈	2 ⁷ / ₁₆		2 ³ / ₄	40	
K102	1	1	25	1	1	25	x	—	—	—	—	—	—	—	—	—	—	—	—	—	—	—	—	—	—
K202/K203	1 ³ / ₁₆	1 ¹ / ₄	30	1 ¹ / ₄	1 ¹ / ₄	30	x	x	—	—	—	—	—	—	—	—	—	—	—	—	—	—	—	—	—
K302/K303	1 ³ / ₈	1 ¹ / ₄ & 1 ³ / ₈	30	1 ¹ / ₄	1 ¹ / ₄	30	x	x	x	x	x	—	—	—	—	—	—	—	—	—	—	—	—	—	—
K402/K403	1 ¹ / ₂	—	40	1 ³ / ₈	1 ³ / ₈	40	x	x	x	x	x	—	—	—	—	—	—	—	—	—	—	—	—	—	x
K513/K514	2	—	50	1 ³ / ₄	1 ³ / ₄	45	—	—	—	—	x	x	x	x	x	x	x	x	—	—	—	—	—	—	x
K613/K614	2	—	50	1 ³ / ₄	1 ³ / ₄	50	—	—	—	—	x	x	x	x	x	—	x	x	x	—	—	—	—	—	x
K713/K714	2 ³ / ₈	—	60	2 ³ / ₈	2 ³ / ₈	60	—	—	—	—	—	—	—	—	—	—	x	x	x	x	—	—	—	—	—
K813/K814	2 ³ / ₄	—	70	2 ⁷ / ₈	2 ⁷ / ₈	70	—	—	—	—	—	—	—	—	—	—	—	—	—	x	x	x	x	—	—
K913/K914	3 ¹ / ₄	—	90	3 ⁵ / ₈	—	90	—	—	—	—	—	—	—	—	—	—	—	—	—	—	—	—	—	—	—
K1013/K1014	4	—	100	4 ³ / ₈	—	110	—	—	—	—	—	—	—	—	—	—	—	—	—	—	—	—	—	—	—

⁽¹⁾ Contact STÖBER Drives for availability.

⁽²⁾ "K" Series stainless steel shaft are single side ONLY.



"K" Series – MGS Adjustable Speed Drive Selection Data



Speed Range Output RPM ⁽¹⁾		Part Number	Maximum		Transition ⁽²⁾		Minimum	
			RPM	Torque in.lbs.	RPM	Torque in.lbs.	RPM	Torque in.lbs.
Max.	Min.							

.50 HP, 1750 RPM Motor

569	81	K102_0040	TD270K 050-050	569	45	81	258	81	258
521	74	K202_0044	TD270K 050-050	521	49	74	281	74	281
409	58	K102_0056	TD270K 050-050	409	63	58	359	58	359
379	54	K102_0060	TD270K 050-050	379	68	54	387	54	387
342	49	K102_0066	TD270K 050-050	342	75	49	428	49	428
340	49	K202_0067	TD270K 050-050	340	75	49	431	49	431
274	39	K102_0083	TD270K 050-050	274	94	39	535	39	535
271	39	K202_0084	TD270K 050-050	271	95	39	541	39	541
246	35	K102_0092	TD270K 050-050	246	104	35	596	35	596
224	32	K102_0100	TD270K 050-050	224	114	32	653	32	653
197	28	K102_0115	TD270K 050-050	197	130	28	745	28	745
180	26	K102_0125	TD270K 050-050	180	142	26	813	26	813
161	23	K102_0140	TD270K 050-050	161	159	23	910	23	910
136	19	K102_0165	TD270K 050-050	136	188	23	974	19	974
135	19	K202_0170	TD270K 050-050	135	190	19	1,086	19	1,086
130	19	K102_0175	TD270K 050-050	130	198	20	1,063	19	1,063
113	16	K102_0200	TD270K 050-050	113	227	24	974	16	974
98	14	K102_0230	TD270K 050-050	98	262	23	1,063	14	1,063
90	13	K102_0250	TD270K 050-050	90	284	30	851	13	851
81	12	K102_0280	TD270K 050-050	81	316	24	1,063	12	1,063
70	10	K403_0320	TD270K 050-050	70	359	10	2,057	10	2,057
70	10	K303_0330	TD270K 050-050	70	362	10	2,074	10	2,074
68	10	K202_0340	TD270K 050-050	68	378	18	1,364	10	1,364
65	9.3	K102_0350	TD270K 050-050	65	395	25	1,063	9.3	1,063
63	9.1	K303_0360	TD270K 050-050	63	397	9.1	2,276	9.1	2,276
58	8.3	K303_0390	TD270K 050-050	58	435	8.3	2,489	8.3	2,489
56	8.0	K302_0410	TD270K 050-050	56	456	14	1,705	8.0	1,705
51	7.2	K303_0450	TD270K 050-050	51	498	7.2	2,851	7.2	2,851
49	7.0	K202_0460	TD270K 050-050	49	520	14	1,772	7.0	1,772
47	6.7	K303_0490	TD270K 050-050	47	539	6.7	3,089	6.7	3,089
45	6.4	K402_0500	TD270K 050-050	45	568	10	2,387	6.4	2,387
46	6.6	K403_0490	TD270K 050-050	46	543	6.6	3,109	6.6	3,109
42	6.0	K303_0540	TD270K 050-050	42	598	7.0	3,100	6.0	3,100
41	5.8	K302_0560	TD270K 050-050	41	627	11	2,345	5.8	2,345
35	5.0	K303_0650	TD270K 050-050	35	727	7.5	3,100	5.0	3,100
34	4.9	K303_0670	TD270K 050-050	34	742	7.6	3,100	4.9	3,100
33	4.7	K402_0690	TD270K 050-050	33	780	7.3	3,283	4.7	3,283
32	4.6	K513_0700	TD270K 050-050	32	777	4.6	4,451	4.6	4,451
29	4.1	K303_0780	TD270K 050-050	29	870	7.9	3,100	4.1	3,100
27	3.8	K514_0850	TD270K 050-050	27	928	3.8	5,316	3.8	5,316
27	3.9	K614_0840	TD270K 050-050	27	915	3.9	5,241	3.9	5,241
26	3.7	K513_0870	TD270K 050-050	26	968	3.7	5,544	3.7	5,544
25	3.6	K303_0900	TD270K 050-050	25	999	8.2	3,100	3.6	3,100
24	3.5	K514_0940	TD270K 050-050	24	1,028	3.5	5,886	3.5	5,886
25	3.5	K614_0930	TD270K 050-050	25	1,014	3.5	5,803	3.5	5,803
24	3.4	K513_0970	TD270K 050-050	24	1,072	3.4	6,138	3.4	6,138

¹⁾ Speed tolerance at rated load is $\pm 3\%$. At less than rated load, minimum speed may increase 5%.

²⁾ The ComTrac drive operates at constant horsepower above transition values and at constant torque below transition values. Note shaded area. Engineering advances may cause slight changes to the information shown.

Housing Styles

N — Foot Mounted **F** — Round Flange **G** — Tapped Holes

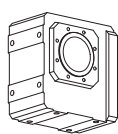
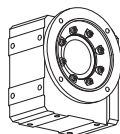
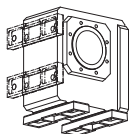

These Housing Styles are available as Hollow (A) or Solid (V) Output.
See page 79 for mounting positions.

Output Shaft Diameter and Hollow Output (inches)

See Page 53 for other options.

Base Module	Output Shaft	Hollow Output	Base Module	Output Shaft	Hollow Output
K102	1.000	1.000	K613/K614	1.750	2.000
K202/K203	1.250	1.187	K713/K714	2.375	2.375
K302/K303	1.250	1.375	K813/K814	2.875	2.750
K402/K403	1.375	1.500	K913/K914	3.625	3.250
K513/K514	1.750	2.000	K1013/K1014	4.375	4.000



"K" Series – MGS Adjustable Speed Drive Selection Data



Speed Range Output RPM ⁽¹⁾		Part Number	Maximum		Transition ⁽²⁾		Minimum	
			RPM	Torque in. lbs.	RPM	Torque in. lbs.	RPM	Torque in. lbs.
Max.	Min.							

.50 HP, 1750 RPM Motor

Continued

21	3.0	K303_1080	TD270K	050-050	21	1,196	8.4	3,100	3.0	3,100
21	3.0	K403_1070	TD270K	050-050	21	1,191	4.9	4,872	3.0	4,872
20	2.9	K514_1130	TD270K	050-050	20	1,232	2.9	7,054	2.9	7,054
20	2.9	K614_1110	TD270K	050-050	20	1,215	2.9	6,955	2.9	6,955
20	2.9	K714_1130	TD270K	050-050	20	1,236	2.9	7,079	2.9	7,079
18	2.6	K514_1250	TD270K	050-050	18	1,364	2.6	7,810	2.6	7,810
18	2.6	K614_1230	TD270K	050-050	18	1,345	2.6	7,700	2.6	7,700
18	2.6	K714_1250	TD270K	050-050	18	1,369	2.6	7,837	2.6	7,837
17	2.4	K303_1340	TD270K	050-050	17	1,490	8.5	3,100	2.4	3,100
17	2.4	K514_1350	TD270K	050-050	17	1,469	2.6	7,972	2.4	7,972
17	2.4	K614_1340	TD270K	050-050	17	1,461	2.4	8,366	2.4	8,366
17	2.4	K714_1370	TD270K	050-050	17	1,496	2.4	8,566	2.4	8,566
15	2.2	K514_1490	TD270K	050-050	15	1,627	2.7	7,972	2.2	7,972
15	2.2	K614_1480	TD270K	050-050	15	1,618	2.2	9,263	2.2	9,263
15	2.1	K714_1520	TD270K	050-050	15	1,656	2.1	9,484	2.1	9,484
14	1.9	K514_1680	TD270K	050-050	14	1,836	2.9	7,972	1.9	7,972
14	2.0	K614_1670	TD270K	050-050	14	1,820	2.0	10,421	2.0	10,421
13	1.8	K303_1790	TD270K	050-050	13	1,983	8.7	3,048	1.8	3,048
13	1.8	K403_1790	TD270K	050-050	13	1,986	5.5	4,737	1.8	4,737
13	1.9	K714_1740	TD270K	050-050	13	1,902	1.9	10,891	1.9	10,891
12	1.7	K514_1860	TD270K	050-050	12	2,033	3.0	7,972	1.7	7,972
12	1.8	K614_1850	TD270K	050-050	12	2,015	1.8	11,537	1.8	11,537
12	1.7	K714_1930	TD270K	050-050	12	2,106	1.7	12,058	1.7	12,058
11	1.5	K403_2150	TD270K	050-050	11	2,389	7.1	3,752	1.5	3,752
10	1.4	K514_2250	TD270K	050-050	10	2,461	3.1	7,972	1.4	7,972
10	1.5	K614_2230	TD270K	050-050	10	2,429	1.6	12,844	1.5	12,844
10	1.4	K714_2260	TD270K	050-050	10	2,473	1.4	14,158	1.4	14,158
9.2	1.3	K614_2460	TD270K	050-050	9.2	2,690	1.7	12,844	1.3	12,844
9.1	1.3	K514_2500	TD270K	050-050	9.1	2,725	3.2	7,972	1.3	7,972
9.1	1.3	K714_2510	TD270K	050-050	9.1	2,738	1.3	15,675	1.3	15,675
8.6	1.2	K614_2660	TD270K	050-050	8.6	2,903	2.0	11,639	1.2	11,639
8.4	1.2	K514_2710	TD270K	050-050	8.4	2,959	3.5	7,268	1.2	7,268
8.3	1.2	K714_2750	TD270K	050-050	8.3	3,006	1.2	17,212	1.2	17,212
7.7	1.1	K614_2940	TD270K	050-050	7.7	3,214	1.8	12,844	1.1	12,844
7.6	1.1	K514_3000	TD270K	050-050	7.6	3,276	3.2	7,972	1.1	7,972
7.5	1.1	K714_3050	TD270K	050-050	7.5	3,328	1.1	19,056	1.1	19,056
6.8	1.0	K614_3330	TD270K	050-050	6.8	3,638	3.0	8,600	1.0	8,600
6.7	1.0	K514_3380	TD270K	050-050	6.7	3,685	4.3	6,105	1.0	6,105
6.6	0.9	K714_3440	TD270K	050-050	6.6	3,758	1.6	14,803	0.9	14,803
6.2	0.9	K614_3690	TD270K	050-050	6.2	4,028	2.7	9,524	0.9	9,524
6.1	0.9	K514_3740	TD270K	050-050	6.1	4,080	3.9	6,761	0.9	6,761
6.0	0.9	K714_3810	TD270K	050-050	6.0	4,160	1.4	16,394	0.9	16,394

Part No. Explanation

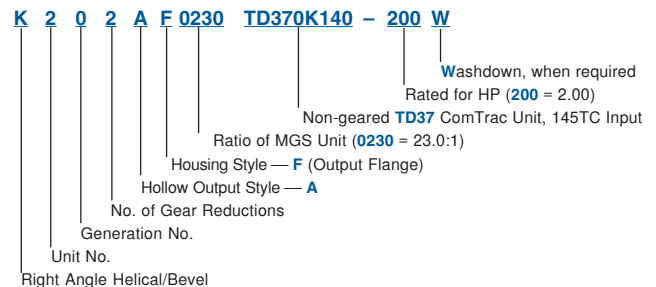

Selection Procedure:

- Determine the MGS/ComTrac combination according to the Input HP of the application and the Output RPM nearest the required **maximum** speed.
- Verify that the output torque will sufficiently meet the application requirements.
- Complete the Part No. per the example by adding "A" or "V" for the Output Style and the Housing Style letter ("N", "F", or "G") as required.



"K" Series – MGS Adjustable Speed Drive Selection Data



Speed Range Output RPM ⁽¹⁾		Part Number	Maximum		Transition ⁽²⁾		Minimum	
			RPM	Torque in.lbs.	RPM	Torque in.lbs.	RPM	Torque in.lbs.
Max.	Min.							

.75 HP, 1750 RPM Motor

569	81	K102_0040	TD270K 050-075	569	67	141	258	81	258
521	74	K202_0044	TD270K 050-075	521	73	129	281	74	281
409	58	K102_0056	TD270K 050-075	409	93	101	359	58	359
379	54	K102_0060	TD270K 050-075	379	100	94	387	54	387
342	49	K102_0066	TD270K 050-075	342	111	85	428	49	428
340	49	K202_0067	TD270K 050-075	340	112	84	431	49	431
274	39	K102_0083	TD270K 050-075	274	139	68	535	39	535
271	39	K202_0084	TD270K 050-075	271	140	67	541	39	541
246	35	K102_0092	TD270K 050-075	246	155	61	596	35	596
224	32	K102_0100	TD270K 050-075	224	169	56	653	32	653
197	28	K102_0115	TD270K 050-075	197	193	49	745	28	745
180	26	K102_0125	TD270K 050-075	180	211	45	813	26	813
161	23	K102_0140	TD270K 050-075	161	236	40	910	23	910
136	19	K102_0165	TD270K 050-075	136	279	38	974	19	974
135	19	K202_0170	TD270K 050-075	135	282	33	1,086	19	1,086
130	19	K102_0175	TD270K 050-075	130	294	35	1,063	19	1,063
113	16	K102_0200	TD270K 050-075	113	337	40	974	16	974
98	14	K102_0230	TD270K 050-075	98	389	37	1,063	14	1,063
90	13	K102_0250	TD270K 050-075	90	422	47	851	13	851
81	12	K102_0280	TD270K 050-075	81	469	37	1,063	12	1,063
70	10	K403_0320	TD270K 050-075	70	534	17	2,057	10	2,057
70	10	K303_0330	TD270K 050-075	70	538	17	2,074	10	2,074
68	10	K202_0340	TD270K 050-075	68	562	29	1,364	10	1,364
65	9.3	K102_0350	TD270K 050-075	65	587	38	1,063	9.3	1,063
66	9.4	K202_0350	TD270K 050-075	66	578	22	1,772	9.4	1,772
63	9.1	K303_0360	TD270K 050-075	63	590	16	2,276	9.1	2,276
58	8.3	K303_0390	TD270K 050-075	58	646	14	2,489	8.3	2,489
56	8.0	K302_0410	TD270K 050-075	56	677	23	1,705	8.0	1,705
51	7.2	K303_0450	TD270K 050-075	51	740	13	2,851	7.2	2,851
49	7.0	K202_0460	TD270K 050-075	49	773	22	1,772	7.0	1,772
47	6.7	K303_0490	TD270K 050-075	47	801	12	3,089	6.7	3,089
45	6.4	K402_0500	TD270K 050-075	45	843	16	2,387	6.4	2,387
46	6.6	K403_0490	TD270K 050-075	46	806	12	3,109	6.6	3,109
42	6.0	K303_0540	TD270K 050-075	42	888	12	3,100	6.0	3,100
41	5.8	K302_0560	TD270K 050-075	41	931	17	2,345	5.8	2,345
35	5.0	K303_0650	TD270K 050-075	35	1,079	12	3,100	5.0	3,100
34	4.9	K303_0670	TD270K 050-075	34	1,102	12	3,100	4.9	3,100
33	4.7	K402_0690	TD270K 050-075	33	1,159	12	3,283	4.7	3,283
32	4.6	K513_0700	TD270K 050-075	32	1,155	8.0	4,451	4.6	4,451
29	4.1	K303_0780	TD270K 050-075	29	1,292	13	3,100	4.1	3,100
27	3.8	K514_0850	TD270K 050-075	27	1,379	6.6	5,316	3.8	5,316
27	3.9	K614_0840	TD270K 050-075	27	1,360	6.7	5,241	3.9	5,241
26	3.7	K513_0870	TD270K 050-075	26	1,438	6.5	5,544	3.7	5,544
25	3.6	K303_0900	TD270K 050-075	25	1,484	13	3,100	3.6	3,100
24	3.5	K514_0940	TD270K 050-075	24	1,527	6.0	5,886	3.5	5,886
25	3.5	K614_0930	TD270K 050-075	25	1,505	6.1	5,803	3.5	5,803

¹⁾ Speed tolerance at rated load is $\pm 3\%$. At less than rated load, minimum speed may increase 5%.

²⁾ The ComTrac drive operates at constant horsepower above transition values and at constant torque below transition values. Note shaded area. Engineering advances may cause slight changes to the information shown.

Housing Styles

N — Foot Mounted **F** — Round Flange **G** — Tapped Holes

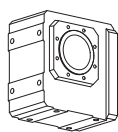
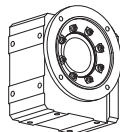
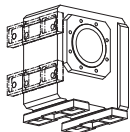

These Housing Styles are available as Hollow (A) or Solid (V) Output.
See page 79 for mounting positions.

Output Shaft Diameter and Hollow Output (inches)

See Page 53 for other options.

Base Module	Output Shaft	Hollow Output	Base Module	Output Shaft	Hollow Output
K102	1.000	1.000	K613/K614	1.750	2.000
K202/K203	1.250	1.187	K713/K714	2.375	2.375
K302/K303	1.250	1.375	K813/K814	2.875	2.750
K402/K403	1.375	1.500	K913/K914	3.625	3.250
K513/K514	1.750	2.000	K1013/K1014	4.375	4.000



"K" Series – MGS Adjustable Speed Drive Selection Data



Speed Range Output RPM ⁽¹⁾		Part Number	Maximum		Transition ⁽²⁾		Minimum	
			RPM	Torque in. lbs.	RPM	Torque in. lbs.	RPM	Torque in. lbs.
Max.	Min.							

.75 HP, 1750 RPM Motor

Continued

24	3.4	K513_0970	TD270K 050-075	24	1,592	5.8	6,138	3.4	6,138
21	3.0	K303_1080	TD270K 050-075	21	1,776	13	3,100	3.0	3,100
21	3.0	K403_1070	TD270K 050-075	21	1,769	7.9	4,872	3.0	4,872
20	2.9	K514_1130	TD270K 050-075	20	1,830	5.0	7,054	2.9	7,054
20	2.9	K614_1110	TD270K 050-075	20	1,804	5.1	6,955	2.9	6,955
20	2.9	K714_1130	TD270K 050-075	20	1,836	5.0	7,079	2.9	7,079
18	2.6	K514_1250	TD270K 050-075	18	2,026	4.5	7,810	2.6	7,810
18	2.6	K614_1230	TD270K 050-075	18	1,997	4.6	7,700	2.6	7,700
18	2.6	K714_1250	TD270K 050-075	18	2,033	4.5	7,837	2.6	7,837
17	2.4	K303_1340	TD270K 050-075	17	2,212	13	3,100	2.4	3,100
17	2.4	K403_1340	TD270K 050-075	17	2,214	8.0	4,872	2.4	4,872
17	2.4	K514_1350	TD270K 050-075	17	2,182	4.5	7,972	2.4	7,972
17	2.4	K614_1340	TD270K 050-075	17	2,170	4.2	8,366	2.4	8,366
17	2.4	K714_1370	TD270K 050-075	17	2,222	4.1	8,566	2.4	8,566
15	2.2	K514_1490	TD270K 050-075	15	2,416	4.6	7,972	2.2	7,972
15	2.2	K614_1480	TD270K 050-075	15	2,403	3.8	9,263	2.2	9,263
15	2.1	K714_1520	TD270K 050-075	15	2,460	3.7	9,484	2.1	9,484
14	1.9	K514_1680	TD270K 050-075	14	2,727	4.7	7,972	1.9	7,972
14	2.0	K614_1670	TD270K 050-075	14	2,703	3.4	10,421	2.0	10,421
13	1.8	K303_1790	TD270K 050-075	13	2,945	12	3,048	1.8	3,048
13	1.8	K403_1790	TD270K 050-075	13	2,950	8.3	4,737	1.8	4,737
13	1.9	K714_1740	TD270K 050-075	13	2,825	3.2	10,891	1.9	10,891
12	1.7	K514_1860	TD270K 050-075	12	3,020	4.8	7,972	1.7	7,972
12	1.8	K614_1850	TD270K 050-075	12	2,993	3.1	11,537	1.8	11,537
12	1.7	K714_1930	TD270K 050-075	12	3,128	2.9	12,058	1.7	12,058
11	1.5	K403_2150	TD270K 050-075	11	3,548	10	3,752	1.5	3,752
10	1.4	K514_2250	TD270K 050-075	10	3,655	4.8	7,972	1.4	7,972
10	1.5	K614_2230	TD270K 050-075	10	3,608	2.8	12,844	1.5	12,844
10	1.4	K714_2260	TD270K 050-075	10	3,672	2.5	14,158	1.4	14,158
9.2	1.3	K614_2460	TD270K 050-075	9.2	3,995	2.9	12,844	1.3	12,844
9.1	1.3	K514_2500	TD270K 050-075	9.1	4,047	4.9	7,972	1.3	7,972
9.1	1.3	K714_2510	TD270K 050-075	9.1	4,066	2.2	15,675	1.3	15,675
8.6	1.2	K614_2660	TD270K 050-075	8.6	4,312	3.3	11,639	1.2	11,639
8.4	1.2	K514_2710	TD270K 050-075	8.4	4,394	5.3	7,268	1.2	7,268
8.3	1.2	K714_2750	TD270K 050-075	8.3	4,464	2.0	17,212	1.2	17,212
7.7	1.1	K614_2940	TD270K 050-075	7.7	4,774	3.0	12,844	1.1	12,844
7.6	1.1	K514_3000	TD270K 050-075	7.6	4,865	4.9	7,972	1.1	7,972
7.5	1.1	K714_3050	TD270K 050-075	7.5	4,943	1.8	19,056	1.1	19,056
6.8	1.0	K614_3330	TD270K 050-075	6.8	5,403	4.5	8,600	1.0	8,600
6.7	1.0	K514_3380	TD270K 050-075	6.7	5,473	6.1	6,105	1.0	6,105
6.6	0.9	K714_3440	TD270K 050-075	6.6	5,581	2.6	14,803	0.9	14,803
6.2	0.9	K614_3690	TD270K 050-075	6.2	5,982	4.1	9,524	0.9	9,524
6.1	0.9	K514_3740	TD270K 050-075	6.1	6,059	5.5	6,761	0.9	6,761
6.0	0.9	K714_3810	TD270K 050-075	6.0	6,178	2.3	16,394	0.9	16,394

Part No. Explanation

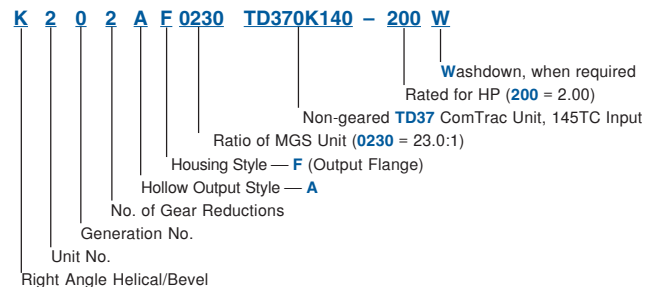

Selection Procedure:

- Determine the MGS/ComTrac combination according to the Input HP of the application and the Output RPM nearest the required **maximum** speed.
- Verify that the output torque will sufficiently meet the application requirements.
- Complete the Part No. per the example by adding "A" or "V" for the Output Style and the Housing Style letter ("N", "F", or "G") as required.



"K" Series – MGS Adjustable Speed Drive Selection Data



Speed Range Output RPM ⁽¹⁾		Part Number	Maximum		Transition ⁽²⁾		Minimum	
			RPM	Torque in.lbs.	RPM	Torque in.lbs.	RPM	Torque in.lbs.
Max.	Min.							

1.0 HP, 1750 RPM Motor

Continued

569	81	K102_0040	TD270K 140-100	569	91	205	258	81	258
521	74	K202_0044	TD270K 140-100	521	99	188	281	74	281
409	58	K102_0056	TD270K 140-100	409	127	147	359	58	359
379	54	K102_0060	TD270K 140-100	379	137	137	387	54	387
342	49	K102_0066	TD270K 140-100	342	151	123	428	49	428
340	49	K202_0067	TD270K 140-100	340	152	123	431	49	431
274	39	K102_0083	TD270K 140-100	274	189	99	535	39	535
271	39	K202_0084	TD270K 140-100	271	191	98	541	39	541
246	35	K102_0092	TD270K 140-100	246	211	89	596	35	596
224	32	K102_0100	TD270K 140-100	224	231	81	653	32	653
197	28	K102_0115	TD270K 140-100	197	264	71	745	28	745
180	26	K102_0125	TD270K 140-100	180	288	65	813	26	813
161	23	K102_0140	TD270K 140-100	161	322	58	910	23	910
136	19	K102_0165	TD270K 140-100	136	381	55	974	19	974
135	19	K202_0170	TD270K 140-100	135	384	49	1,086	19	1,086
130	19	K102_0175	TD270K 140-100	130	400	50	1,063	19	1,063
113	16	K102_0200	TD270K 140-100	113	459	56	974	16	974
112	16	K202_0200	TD270K 140-100	112	463	40	1,310	16	1,310
98	14	K102_0230	TD270K 140-100	98	530	51	1,063	14	1,063
98	14	K202_0230	TD270K 140-100	98	528	35	1,494	14	1,494
90	13	K102_0250	TD270K 140-100	90	575	64	851	13	851
91	13	K202_0250	TD270K 140-100	91	573	33	1,619	13	1,619
81	12	K102_0280	TD270K 140-100	81	639	51	1,063	12	1,063
81	12	K202_0280	TD270K 140-100	81	637	30	1,772	12	1,772
70	10	K403_0320	TD270K 140-100	70	727	25	2,057	10	2,057
70	10	K303_0330	TD270K 140-100	70	733	25	2,074	10	2,074
68	10	K202_0340	TD270K 140-100	68	766	40	1,364	10	1,364
68	10	K302_0340	TD270K 140-100	68	766	24	2,166	10	2,166
65	9.3	K102_0350	TD270K 140-100	65	800	51	1,063	9.3	1,063
66	9.4	K202_0350	TD270K 140-100	66	787	30	1,772	9.4	1,772
63	9.1	K303_0360	TD270K 140-100	63	805	23	2,276	9.1	2,276
58	8.3	K303_0390	TD270K 140-100	58	880	21	2,489	8.3	2,489
56	8.0	K302_0410	TD270K 140-100	56	923	32	1,705	8.0	1,705
56	8.0	K402_0410	TD270K 140-100	56	923	20	2,611	8.0	2,611
51	7.2	K303_0450	TD270K 140-100	51	1,008	18	2,851	7.2	2,851
49	7.0	K202_0460	TD270K 140-100	49	1,053	31	1,772	7.0	1,772
49	7.0	K302_0460	TD270K 140-100	49	1,053	18	2,979	7.0	2,979
47	6.7	K303_0490	TD270K 140-100	47	1,092	17	3,089	6.7	3,089
45	6.4	K402_0500	TD270K 140-100	45	1,149	23	2,387	6.4	2,387
46	6.6	K403_0490	TD270K 140-100	46	1,099	17	3,109	6.6	3,109
42	6.0	K303_0540	TD270K 140-100	42	1,210	17	3,100	6.0	3,100
41	5.8	K302_0560	TD270K 140-100	41	1,269	23	2,345	5.8	2,345
41	5.8	K402_0560	TD270K 140-100	41	1,269	15	3,590	5.8	3,590
35	5.0	K303_0650	TD270K 140-100	35	1,471	17	3,100	5.0	3,100
34	4.9	K303_0670	TD270K 140-100	34	1,502	17	3,100	4.9	3,100
33	4.7	K402_0690	TD270K 140-100	33	1,580	17	3,283	4.7	3,283
32	4.6	K513_0700	TD270K 140-100	32	1,574	12	4,451	4.6	4,451
29	4.1	K303_0780	TD270K 140-100	29	1,761	17	3,100	4.1	3,100

¹⁾ Speed tolerance at rated load is $\pm 3\%$. At less than rated load, minimum speed may increase 5%.

²⁾ The ComTrac drive operates at constant horsepower above transition values and at constant torque below transition values. Note shaded area. Engineering advances may cause slight changes to the information shown.

Housing Styles

N — Foot Mounted **F** — Round Flange **G** — Tapped Holes

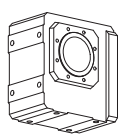
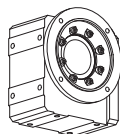
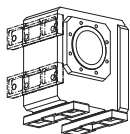

These Housing Styles are available as Hollow (A) or Solid (V) Output.
See page 79 for mounting positions.

Output Shaft Diameter and Hollow Output (inches)

See Page 53 for other options.

Base Module	Output Shaft	Hollow Output	Base Module	Output Shaft	Hollow Output
K102	1.000	1.000	K613/K614	1.750	2.000
K202/K203	1.250	1.187	K713/K714	2.375	2.375
K302/K303	1.250	1.375	K813/K814	2.875	2.750
K402/K403	1.375	1.500	K913/K914	3.625	3.250
K513/K514	1.750	2.000	K1013/K1014	4.375	4.000



"K" Series – MGS Adjustable Speed Drive Selection Data



Speed Range Output RPM ⁽¹⁾		Part Number	Maximum		Transition ⁽²⁾		Minimum	
			RPM	Torque in. lbs.	RPM	Torque in. lbs.	RPM	Torque in. lbs.
Max.	Min.							

1.0 HP, 1750 RPM Motor

Continued

29	4.2	K403_0780	TD270K	140-100	29	1,754	11	4,872	4.2	4,872
27	3.8	K514_0850	TD270K	140-100	27	1,880	10	5,316	3.8	5,316
27	3.9	K614_0840	TD270K	140-100	27	1,854	10	5,241	3.9	5,241
26	3.7	K513_0870	TD270K	140-100	26	1,960	9.4	5,544	3.7	5,544
25	3.6	K303_0900	TD270K	140-100	25	2,023	17	3,100	3.6	3,100
25	3.6	K403_0900	TD270K	140-100	25	2,023	11	4,872	3.6	4,872
24	3.5	K514_0940	TD270K	140-100	24	2,081	8.7	5,886	3.5	5,886
25	3.5	K614_0930	TD270K	140-100	25	2,052	8.8	5,803	3.5	5,803
24	3.4	K513_0970	TD270K	140-100	24	2,171	8.5	6,138	3.4	6,138
21	3.0	K303_1080	TD270K	140-100	21	2,421	17	3,100	3.0	3,100
21	3.0	K403_1070	TD270K	140-100	21	2,412	11	4,872	3.0	4,872
20	2.9	K514_1130	TD270K	140-100	20	2,494	7.3	7,054	2.9	7,054
20	2.9	K614_1110	TD270K	140-100	20	2,460	7.4	6,955	2.9	6,955
20	2.9	K714_1130	TD270K	140-100	20	2,503	7.2	7,079	2.9	7,079
18	2.6	K514_1250	TD270K	140-100	18	2,762	6.6	7,810	2.6	7,810
18	2.6	K614_1230	TD270K	140-100	18	2,723	6.7	7,700	2.6	7,700
18	2.6	K714_1250	TD270K	140-100	18	2,772	6.5	7,837	2.6	7,837
17	2.4	K303_1340	TD270K	140-100	17	3,016	17	3,100	2.4	3,100
17	2.4	K403_1340	TD270K	140-100	17	3,019	11	4,872	2.4	4,872
17	2.4	K514_1350	TD270K	140-100	17	2,975	6.5	7,972	2.4	7,972
17	2.4	K614_1340	TD270K	140-100	17	2,959	6.1	8,366	2.4	8,366
17	2.4	K714_1370	TD270K	140-100	17	3,029	6.0	8,566	2.4	8,566
15	2.2	K514_1490	TD270K	140-100	15	3,293	6.5	7,972	2.2	7,972
15	2.2	K614_1480	TD270K	140-100	15	3,276	5.5	9,263	2.2	9,263
15	2.1	K714_1520	TD270K	140-100	15	3,354	5.4	9,484	2.1	9,484
14	1.9	K514_1680	TD270K	140-100	14	3,718	6.6	7,972	1.9	7,972
14	2.0	K614_1670	TD270K	140-100	14	3,685	4.9	10,421	2.0	10,421
13	1.8	K403_1790	TD270K	140-100	13	4,022	11	4,737	1.8	4,737
13	1.9	K714_1740	TD270K	140-100	13	3,851	4.7	10,891	1.9	10,891
12	1.7	K514_1860	TD270K	140-100	12	4,117	6.6	7,972	1.7	7,972
12	1.8	K614_1850	TD270K	140-100	12	4,080	4.4	11,537	1.8	11,537
12	1.7	K714_1930	TD270K	140-100	12	4,264	4.3	12,058	1.7	12,058
10	1.4	K514_2250	TD270K	140-100	10	4,983	6.6	7,972	1.4	7,972
10	1.5	K614_2230	TD270K	140-100	10	4,919	4.0	12,844	1.5	12,844
10	1.4	K714_2260	TD270K	140-100	10	5,007	3.6	14,158	1.4	14,158
9.2	1.3	K614_2460	TD270K	140-100	9.2	5,446	4.1	12,844	1.3	12,844
9.1	1.3	K514_2500	TD270K	140-100	9.1	5,517	6.6	7,972	1.3	7,972
9.1	1.3	K714_2510	TD270K	140-100	9.1	5,543	3.3	15,675	1.3	15,675
8.6	1.2	K614_2660	TD270K	140-100	8.6	5,879	4.5	11,639	1.2	11,639
8.4	1.2	K514_2710	TD270K	140-100	8.4	5,991	7.1	7,268	1.2	7,268
8.3	1.2	K714_2750	TD270K	140-100	8.3	6,087	3.0	17,212	1.2	17,212
7.7	1.1	K614_2940	TD270K	140-100	7.7	6,509	4.1	12,844	1.1	12,844
7.6	1.1	K514_3000	TD270K	140-100	7.6	6,633	6.5	7,972	1.1	7,972
7.5	1.1	K714_3050	TD270K	140-100	7.5	6,739	2.7	19,056	1.1	19,056
6.8	1.0	K614_3330	TD270K	140-100	6.8	7,367	6.0	8,600	1.0	8,600
6.6	0.9	K714_3440	TD270K	140-100	6.6	7,608	3.6	14,803	0.9	14,803
6.2	0.9	K614_3690	TD270K	140-100	6.2	8,156	5.4	9,524	0.9	9,524
6.0	0.9	K714_3810	TD270K	140-100	6.0	8,423	3.2	16,394	0.9	16,394

Part No. Explanation

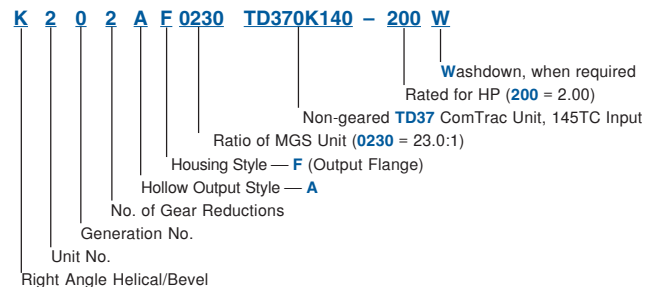

Selection Procedure:

- Determine the MGS/ComTrac combination according to the Input HP of the application and the Output RPM nearest the required **maximum** speed.
- Verify that the output torque will sufficiently meet the application requirements.
- Complete the Part No. per the example by adding "A" or "V" for the Output Style and the Housing Style letter ("N", "F", or "G") as required.



"K" Series – MGS Adjustable Speed Drive Selection Data



Speed Range		Part Number	Maximum		Transition ⁽²⁾		Minimum	
Output RPM ⁽¹⁾			RPM	Torque in.lbs.	RPM	Torque in.lbs.	RPM	Torque in.lbs.
Max.	Min.							

1.50 HP, 1750 RPM Motor

547	109	K102_0040	TD370K 140-150	547	141	209	378	109	378
501	100	K202_0044	TD370K 140-150	501	154	192	412	100	412
423	85	K202_0052	TD370K 140-150	423	182	162	489	85	489
393	79	K102_0056	TD370K 140-150	393	196	150	526	79	526
365	73	K102_0060	TD370K 140-150	365	211	139	567	73	567
329	66	K102_0066	TD370K 140-150	329	234	126	628	66	628
327	65	K202_0067	TD370K 140-150	327	235	125	632	65	632
307	61	K202_0071	TD370K 140-150	307	250	117	673	61	673
263	53	K102_0083	TD370K 140-150	263	292	101	785	53	785
261	52	K202_0084	TD370K 140-150	261	295	100	794	52	794
237	47	K102_0092	TD370K 140-150	237	325	90	874	47	874
236	47	K302_0093	TD370K 140-150	236	326	90	876	47	876
216	43	K102_0100	TD370K 140-150	216	357	86	920	43	920
217	43	K202_0100	TD370K 140-150	217	354	83	952	43	952
189	38	K102_0115	TD370K 140-150	189	407	87	916	38	916
189	38	K202_0115	TD370K 140-150	189	406	72	1,091	38	1,091
173	35	K102_0125	TD370K 140-150	173	444	88	914	35	914
172	34	K202_0125	TD370K 140-150	172	447	66	1,201	34	1,201
155	31	K102_0140	TD370K 140-150	155	497	89	911	31	911
158	32	K202_0140	TD370K 140-150	158	487	60	1,309	32	1,309
130	26	K202_0170	TD370K 140-150	130	593	50	1,593	26	1,593
125	25	K102_0175	TD370K 140-150	125	618	88	914	25	914
125	25	K202_0175	TD370K 140-150	125	615	48	1,651	25	1,651
108	22	K202_0200	TD370K 140-150	108	715	45	1,772	22	1,772
94	19	K202_0230	TD370K 140-150	94	815	45	1,772	19	1,772
94	19	K302_0230	TD370K 140-150	94	819	36	2,201	19	2,201
87	17	K202_0250	TD370K 140-150	87	884	46	1,772	17	1,772
87	17	K302_0250	TD370K 140-150	87	889	33	2,387	17	2,387
78	16	K202_0280	TD370K 140-150	78	983	46	1,772	16	1,772
78	16	K302_0280	TD370K 140-150	78	981	30	2,635	16	2,635
68	14	K403_0320	TD370K 140-150	68	1,123	26	3,017	14	3,017
67	13	K303_0330	TD370K 140-150	67	1,132	26	3,041	13	3,041
65	13	K302_0340	TD370K 140-150	65	1,183	37	2,217	13	2,217
65	13	K402_0340	TD370K 140-150	65	1,185	25	3,183	13	3,183
63	13	K202_0350	TD370K 140-150	63	1,216	45	1,772	13	1,772
63	13	K302_0350	TD370K 140-150	63	1,222	26	3,100	13	3,100
61	12	K303_0360	TD370K 140-150	61	1,242	25	3,100	12	3,100
56	11	K303_0390	TD370K 140-150	56	1,359	25	3,100	11	3,100
54	11	K402_0410	TD370K 140-150	54	1,425	30	2,729	11	2,729
50	10	K513_0440	TD370K 140-150	50	1,508	19	4,052	10	4,052
49	10	K303_0450	TD370K 140-150	49	1,557	26	3,100	10	3,100
49	10	K403_0450	TD370K 140-150	49	1,544	19	4,149	10	4,149
47	9.5	K302_0460	TD370K 140-150	47	1,626	27	3,048	9.5	3,048
47	9.4	K402_0460	TD370K 140-150	47	1,629	18	4,377	9.4	4,377
45	9.1	K513_0480	TD370K 140-150	45	1,670	17	4,486	9.1	4,486
45	9.0	K303_0490	TD370K 140-150	45	1,686	26	3,100	9.0	3,100

¹⁾ Speed tolerance at rated load is $\pm 3\%$. At less than rated load, minimum speed may increase 5%.

²⁾ The ComTrac drive operates at constant horsepower above transition values and at constant torque below transition values. Note shaded area. Engineering advances may cause slight changes to the information shown.

Housing Styles

N — Foot Mounted **F** — Round Flange **G** — Tapped Holes

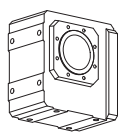
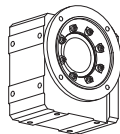
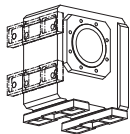

These Housing Styles are available as Hollow (A) or Solid (V) Output.
See page 79 for mounting positions.

Output Shaft Diameter and Hollow Output (inches)

See Page 53 for other options.

Base Module	Output Shaft	Hollow Output	Base Module	Output Shaft	Hollow Output
K102	1.000	1.000	K613/K614	1.750	2.000
K202/K203	1.250	1.187	K713/K714	2.375	2.375
K302/K303	1.250	1.375	K813/K814	2.875	2.750
K402/K403	1.375	1.500	K913/K914	3.625	3.250
K513/K514	1.750	2.000	K1013/K1014	4.375	4.000



"K" Series – MGS Adjustable Speed Drive Selection Data



Speed Range Output RPM ⁽¹⁾		Part Number	Maximum		Transition ⁽²⁾		Minimum	
			RPM	Torque in. lbs.	RPM	Torque in. lbs.	RPM	Torque in. lbs.
Max.	Min.							

1.50 HP, 1750 RPM Motor

Continued next page

45	8.9	K403_0490	TD370K 140-150	45	1,697	17	4,559	8.9	4,559
41	8.1	K303_0540	TD370K 140-150	41	1,868	26	3,100	8.1	3,100
41	8.1	K403_0540	TD370K 140-150	41	1,862	16	4,872	8.1	4,872
39	7.9	K402_0560	TD370K 140-150	39	1,960	22	3,752	7.9	3,752
38	7.5	K513_0580	TD370K 140-150	38	2,021	14	5,430	7.5	5,430
33	6.7	K303_0650	TD370K 140-150	33	2,271	25	3,100	6.7	3,100
33	6.7	K403_0650	TD370K 140-150	33	2,271	16	4,872	6.7	4,872
34	6.9	K613_0640	TD370K 140-150	34	2,209	13	5,935	6.9	5,935
33	6.5	K303_0670	TD370K 140-150	33	2,318	25	3,100	6.5	3,100
33	6.5	K403_0670	TD370K 140-150	33	2,333	16	4,872	6.5	4,872
32	6.4	K613_0690	TD370K 140-150	32	2,384	12	6,406	6.4	6,406
31	6.2	K513_0700	TD370K 140-150	31	2,430	12	6,528	6.2	6,528
29	5.7	K613_0760	TD370K 140-150	29	2,640	11	7,092	5.7	7,092
28	5.6	K303_0780	TD370K 140-150	28	2,719	25	3,100	5.6	3,100
28	5.6	K403_0780	TD370K 140-150	28	2,708	16	4,872	5.6	4,872
28	5.6	K513_0780	TD370K 140-150	28	2,690	11	7,228	5.6	7,228
26	5.1	K514_0850	TD370K 140-150	26	2,902	10	7,797	5.1	7,797
26	5.2	K614_0840	TD370K 140-150	26	2,861	10	7,687	5.2	7,687
25	5.0	K513_0870	TD370K 140-150	25	3,027	13	6,105	5.0	6,105
25	5.1	K613_0860	TD370K 140-150	25	2,988	10	8,028	5.1	8,028
24	4.9	K403_0900	TD370K 140-150	24	3,123	16	4,872	4.9	4,872
24	4.7	K614_0930	TD370K 140-150	24	3,168	9.0	8,511	4.7	8,511
23	4.5	K513_0970	TD370K 140-150	23	3,351	12	6,761	4.5	6,761
23	4.6	K514_0940	TD370K 140-150	23	3,213	10	7,972	4.6	7,972
23	4.6	K613_0950	TD370K 140-150	23	3,308	8.8	8,888	4.6	8,888
20	4.1	K403_1070	TD370K 140-150	20	3,723	16	4,872	4.1	4,872
20	3.9	K614_1110	TD370K 140-150	20	3,797	7.5	10,201	3.9	10,201
19	3.9	K514_1130	TD370K 140-150	19	3,851	10	7,972	3.9	7,972
18	3.5	K514_1250	TD370K 140-150	18	4,263	10	7,972	3.5	7,972
18	3.6	K614_1230	TD370K 140-150	18	4,204	6.8	11,294	3.6	11,294
17	3.5	K714_1250	TD370K 140-150	17	4,279	6.7	11,495	3.5	11,495
16	3.3	K403_1340	TD370K 140-150	16	4,660	16	4,872	3.3	4,872
16	3.3	K514_1350	TD370K 140-150	16	4,592	10	7,972	3.3	7,972
16	3.3	K614_1340	TD370K 140-150	16	4,567	6.2	12,270	3.3	12,270
16	3.2	K714_1370	TD370K 140-150	16	4,676	6.1	12,564	3.2	12,564
15	2.9	K514_1490	TD370K 140-150	15	5,084	10	7,972	2.9	7,972
15	3.0	K614_1480	TD370K 140-150	15	5,057	6.0	12,844	3.0	12,844
14	2.9	K714_1520	TD370K 140-150	14	5,177	5.5	13,910	2.9	13,910
13	2.6	K514_1680	TD370K 140-150	13	5,740	10	7,972	2.6	7,972
13	2.6	K614_1670	TD370K 140-150	13	5,689	6.1	12,844	2.6	12,844
13	2.5	K714_1740	TD370K 140-150	13	5,945	4.8	15,973	2.5	15,973
12	2.3	K514_1860	TD370K 140-150	12	6,355	10	7,972	2.3	7,972
12	2.4	K614_1850	TD370K 140-150	12	6,299	6.1	12,844	2.4	12,844
11	2.3	K714_1930	TD370K 140-150	11	6,582	4.3	17,684	2.3	17,684
10	2.0	K614_2230	TD370K 140-150	10	7,594	6.1	12,844	2.0	12,844
10	1.9	K514_2250	TD370K 140-150	10	7,693	9.4	7,972	1.9	7,972

Part No. Explanation

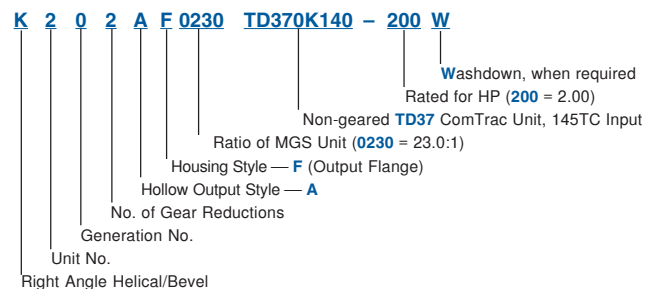

Selection Procedure:

- Determine the MGS/ComTrac combination according to the Input HP of the application and the Output RPM nearest the required **maximum** speed.
- Verify that the output torque will sufficiently meet the application requirements.
- Complete the Part No. per the example by adding "A" or "V" for the Output Style and the Housing Style letter ("N", "F", or "G") as required.



"K" Series – MGS Adjustable Speed Drive Selection Data



Speed Range Output RPM ⁽¹⁾		Part Number	Maximum		Transition ⁽²⁾		Minimum	
			RPM	Torque in.lbs.	RPM	Torque in.lbs.	RPM	Torque in.lbs.
Max.	Min.							

1.50 HP, 1750 RPM Motor Continued

10	1.9	K714_2260	TD370K 140-150	10	7,729	3.7	20,765	1.9	20,765
8.9	1.8	K614_2460	TD370K 140-150	9	8,407	6.1	12,844	1.8	12,844
8.7	1.7	K714_2510	TD370K 140-150	9	8,557	3.6	21,259	1.7	21,259
8.2	1.6	K614_2660	TD370K 140-150	8	9,075	6.6	11,639	1.6	11,639
7.9	1.6	K714_2750	TD370K 140-150	8	9,396	4.1	19,244	1.6	19,244
7.4	1.5	K614_2940	TD370K 140-150	7	10,048	6.0	12,844	1.5	12,844
7.2	1.4	K714_3050	TD370K 140-150	7	10,403	3.7	21,259	1.4	21,259
6.4	1.3	K714_3440	TD370K 140-150	6	11,745	5.2	14,803	1.3	14,803
5.7	1.1	K714_3810	TD370K 140-150	6	13,004	4.7	16,394	1.1	16,394

2.0 HP, 1750 RPM Motor

547	109	K102_0040	TD370K 140-200	547	192	292	378	109	378
501	100	K202_0044	TD370K 140-200	501	210	267	412	100	412
423	85	K202_0052	TD370K 140-200	423	249	225	489	85	489
393	79	K102_0056	TD370K 140-200	393	267	209	526	79	526
365	73	K102_0060	TD370K 140-200	365	288	194	567	73	567
329	66	K102_0066	TD370K 140-200	329	319	176	628	66	628
327	65	K202_0067	TD370K 140-200	327	321	174	632	65	632
307	61	K202_0071	TD370K 140-200	307	342	164	673	61	673
263	53	K102_0083	TD370K 140-200	263	399	141	781	53	781
261	52	K202_0084	TD370K 140-200	261	403	139	794	52	794
237	47	K102_0092	TD370K 140-200	237	444	142	779	47	779
238	48	K202_0092	TD370K 140-200	238	441	127	869	48	869
236	47	K302_0093	TD370K 140-200	236	445	126	876	47	876
216	43	K102_0100	TD370K 140-200	216	487	141	781	43	781
217	43	K202_0100	TD370K 140-200	217	484	116	952	43	952
189	38	K102_0115	TD370K 140-200	189	555	139	784	38	784
189	38	K202_0115	TD370K 140-200	189	554	101	1,091	38	1,091
173	35	K102_0125	TD370K 140-200	173	606	138	787	35	787
172	34	K202_0125	TD370K 140-200	172	610	92	1,201	34	1,201
155	31	K102_0140	TD370K 140-200	155	678	135	792	31	792
158	32	K202_0140	TD370K 140-200	158	665	84	1,309	32	1,309
130	26	K202_0170	TD370K 140-200	130	810	69	1,593	26	1,593
129	26	K302_0170	TD370K 140-200	129	813	69	1,601	26	1,601
125	25	K202_0175	TD370K 140-200	125	839	67	1,651	25	1,651
126	25	K302_0175	TD370K 140-200	126	830	67	1,634	25	1,634
108	22	K202_0200	TD370K 140-200	108	976	62	1,772	22	1,772
108	22	K302_0200	TD370K 140-200	108	974	58	1,917	22	1,917
94	19	K202_0230	TD370K 140-200	94	1,113	62	1,772	19	1,772
94	19	K302_0230	TD370K 140-200	94	1,119	50	2,201	19	2,201
87	17	K202_0250	TD370K 140-200	87	1,207	62	1,772	17	1,772
87	17	K302_0250	TD370K 140-200	87	1,213	46	2,387	17	2,387
78	16	K202_0280	TD370K 140-200	78	1,342	61	1,772	16	1,772
78	16	K302_0280	TD370K 140-200	78	1,339	42	2,635	16	2,635

¹⁾ Speed tolerance at rated load is ±3%. At less than rated load, minimum speed may increase 5%.

²⁾ The ComTrac drive operates at constant horsepower above transition values and at constant torque below transition values. Note shaded area. Engineering advances may cause slight changes to the information shown.

Housing Styles

N — Foot Mounted **F** — Round Flange **G** — Tapped Holes

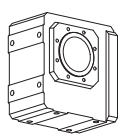
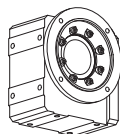
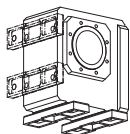

These Housing Styles are available as Hollow (A) or Solid (V) Output.
See page 79 for mounting positions.

Output Shaft Diameter and Hollow Output (inches)

See Page 53 for other options.

Base Module	Output Shaft	Hollow Output	Base Module	Output Shaft	Hollow Output
K102	1.000	1.000	K613/K614	1.750	2.000
K202/K203	1.250	1.187	K713/K714	2.375	2.375
K302/K303	1.250	1.375	K813/K814	2.875	2.750
K402/K403	1.375	1.500	K913/K914	3.625	3.250
K513/K514	1.750	2.000	K1013/K1014	4.375	4.000



"K" Series – MGS Adjustable Speed Drive Selection Data



Speed Range Output RPM ⁽¹⁾		Part Number	Maximum		Transition ⁽²⁾		Minimum	
			RPM	Torque in. lbs.	RPM	Torque in. lbs.	RPM	Torque in. lbs.
Max.	Min.							

2.0 HP, 1750 RPM Motor

Continued next page

68	14	K403_0320	TD370K 140-200	68	1,533	36	3,017	14	3,017
67	13	K303_0330	TD370K 140-200	67	1,545	36	3,041	13	3,041
65	13	K302_0340	TD370K 140-200	65	1,614	49	2,217	13	2,217
65	13	K402_0340	TD370K 140-200	65	1,617	35	3,183	13	3,183
63	13	K202_0350	TD370K 140-200	63	1,659	60	1,772	13	1,772
63	13	K302_0350	TD370K 140-200	63	1,668	36	3,100	13	3,100
63	13	K402_0350	TD370K 140-200	63	1,669	34	3,285	13	3,285
61	12	K303_0360	TD370K 140-200	61	1,696	35	3,100	12	3,100
61	12	K403_0360	TD370K 140-200	61	1,691	33	3,327	12	3,327
56	11	K303_0390	TD370K 140-200	56	1,855	35	3,100	11	3,100
56	11	K403_0390	TD370K 140-200	56	1,848	30	3,637	11	3,637
54	11	K402_0410	TD370K 140-200	54	1,945	40	2,729	11	2,729
50	10	K513_0440	TD370K 140-200	50	2,059	27	4,052	10	4,052
49	10	K303_0450	TD370K 140-200	49	2,125	35	3,100	10	3,100
49	10	K403_0450	TD370K 140-200	49	2,108	26	4,149	10	4,149
47	9.5	K302_0460	TD370K 140-200	47	2,220	36	3,048	9.5	3,048
47	9.4	K402_0460	TD370K 140-200	47	2,224	25	4,377	9.4	4,377
45	9.1	K513_0480	TD370K 140-200	45	2,279	24	4,486	9.1	4,486
45	9.0	K303_0490	TD370K 140-200	45	2,302	35	3,100	9.0	3,100
45	8.9	K403_0490	TD370K 140-200	45	2,316	24	4,559	8.9	4,559
41	8.1	K303_0540	TD370K 140-200	41	2,550	34	3,100	8.1	3,100
41	8.1	K403_0540	TD370K 140-200	41	2,541	22	4,872	8.1	4,872
39	7.9	K402_0560	TD370K 140-200	39	2,675	29	3,752	7.9	3,752
38	7.5	K513_0580	TD370K 140-200	38	2,759	20	5,430	7.5	5,430
33	6.7	K303_0650	TD370K 140-200	33	3,100	33	3,100	6.7	3,100
33	6.7	K403_0650	TD370K 140-200	33	3,100	22	4,872	6.7	4,872
34	6.8	K513_0650	TD370K 140-200	34	3,055	18	6,012	6.8	6,012
34	6.9	K613_0640	TD370K 140-200	34	3,015	18	5,935	6.9	5,935
33	6.5	K403_0670	TD370K 140-200	33	3,185	22	4,872	6.5	4,872
32	6.4	K613_0690	TD370K 140-200	32	3,255	17	6,406	6.4	6,406
31	6.2	K513_0700	TD370K 140-200	31	3,317	17	6,528	6.2	6,528
29	5.7	K613_0760	TD370K 140-200	29	3,604	15	7,092	5.7	7,092
28	5.6	K403_0780	TD370K 140-200	28	3,696	22	4,872	5.6	4,872
28	5.6	K513_0780	TD370K 140-200	28	3,672	15	7,228	5.6	7,228
26	5.1	K514_0850	TD370K 140-200	26	3,961	14	7,797	5.1	7,797
26	5.2	K614_0840	TD370K 140-200	26	3,906	14	7,687	5.2	7,687
25	5.0	K513_0870	TD370K 140-200	25	4,131	18	6,105	5.0	6,105
25	5.1	K613_0860	TD370K 140-200	25	4,079	14	8,028	5.1	8,028
24	4.9	K403_0900	TD370K 140-200	24	4,262	22	4,872	4.9	4,872
24	4.7	K614_0930	TD370K 140-200	24	4,324	13	8,511	4.7	8,511
23	4.5	K513_0970	TD370K 140-200	23	4,574	16	6,761	4.5	6,761
23	4.6	K514_0940	TD370K 140-200	23	4,386	13	7,972	4.6	7,972

Part No. Explanation

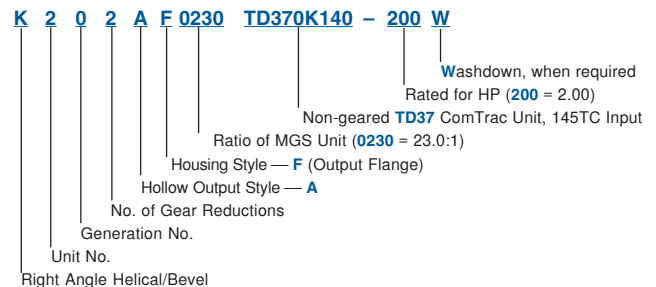

Selection Procedure:

- Determine the MGS/ComTrac combination according to the Input HP of the application and the Output RPM nearest the required **maximum** speed.
- Verify that the output torque will sufficiently meet the application requirements.
- Complete the Part No. per the example by adding "A" or "V" for the Output Style and the Housing Style letter ("N", "F", or "G") as required.



"K" Series – MGS Adjustable Speed Drive Selection Data



Speed Range Output RPM ⁽¹⁾		Part Number	Maximum		Transition ⁽²⁾		Minimum	
			RPM	Torque in.lbs.	RPM	Torque in.lbs.	RPM	Torque in.lbs.
Max.	Min.							

2.0 HP, 1750 RPM Motor

Continued

23	4.6	K613_0950	TD370K 140-200	23	4,516	12	8,888	4.6	8,888
20	3.9	K614_1110	TD370K 140-200	20	5,183	10	10,201	3.9	10,201
19	3.9	K514_1130	TD370K 140-200	19	5,256	13	7,972	3.9	7,972
19	3.9	K714_1130	TD370K 140-200	19	5,275	10	10,383	3.9	10,383
18	3.5	K514_1250	TD370K 140-200	18	5,820	13	7,972	3.5	7,972
18	3.6	K614_1230	TD370K 140-200	18	5,738	9	11,294	3.6	11,294
17	3.5	K714_1250	TD370K 140-200	17	5,840	9	11,495	3.5	11,495
16	3.3	K514_1350	TD370K 140-200	16	6,269	13	7,972	3.3	7,972
16	3.3	K614_1340	TD370K 140-200	16	6,234	9	12,270	3.3	12,270
16	3.2	K714_1370	TD370K 140-200	16	6,383	9	12,564	3.2	12,564
15	2.9	K514_1490	TD370K 140-200	15	6,940	13	7,972	2.9	7,972
15	3.0	K614_1480	TD370K 140-200	15	6,902	8	12,844	3.0	12,844
14	2.9	K714_1520	TD370K 140-200	14	7,067	8	13,910	2.9	13,910
13	2.6	K514_1680	TD370K 140-200	13	7,836	13	7,972	2.6	7,972
13	2.6	K614_1670	TD370K 140-200	13	7,765	8	12,844	2.6	12,844
13	2.5	K714_1740	TD370K 140-200	13	8,116	7	15,973	2.5	15,973
12	2.4	K614_1850	TD370K 140-200	12	8,597	8	12,844	2.4	12,844
11	2.3	K714_1930	TD370K 140-200	11	8,985	6	17,684	2.3	17,684
10	2.0	K614_2230	TD370K 140-200	10	10,366	8	12,844	2.0	12,844
10	1.9	K714_2260	TD370K 140-200	10	10,550	5	20,765	1.9	20,765
8.9	1.8	K614_2460	TD370K 140-200	8.9	11,476	8	12,844	1.8	12,844
8.7	1.7	K714_2510	TD370K 140-200	8.7	11,681	5	21,259	1.7	21,259
7.9	1.6	K714_2750	TD370K 140-200	7.9	12,826	6	19,244	1.6	19,244
7.2	1.4	K714_3050	TD370K 140-200	7.2	14,200	5	21,259	1.4	21,259

3.0 HP, 1750 RPM Motor

Continued next page

547	109	K202_0040	TD470K 180-300	547	297	237	687	109	687
501	100	K202_0044	TD470K 180-300	501	324	218	750	100	750
423	85	K202_0052	TD470K 180-300	423	384	183	890	85	890
407	81	K302_0054	TD470K 180-300	407	399	177	924	81	924
365	73	K202_0060	TD470K 180-300	365	445	158	1,031	73	1,031
327	65	K202_0067	TD470K 180-300	327	496	142	1,148	65	1,148
307	61	K202_0071	TD470K 180-300	307	528	133	1,223	61	1,223
296	59	K302_0074	TD470K 180-300	296	548	128	1,270	59	1,270
293	59	K402_0075	TD470K 180-300	293	553	127	1,281	59	1,281
261	52	K202_0084	TD470K 180-300	261	623	113	1,443	52	1,443
259	52	K302_0084	TD470K 180-300	259	626	112	1,451	52	1,451
238	48	K202_0092	TD470K 180-300	238	681	107	1,530	48	1,530
237	47	K402_0092	TD470K 180-300	237	685	103	1,588	47	1,588
236	47	K302_0093	TD470K 180-300	236	687	102	1,592	47	1,592
217	43	K202_0100	TD470K 180-300	217	747	108	1,525	43	1,525

¹⁾ Speed tolerance at rated load is ±3%. At less than rated load, minimum speed may increase 5%.

²⁾ The ComTrac drive operates at constant horsepower above transition values and at constant torque below transition values. Note shaded area. Engineering advances may cause slight changes to the information shown.

Housing Styles

N — Foot Mounted F — Round Flange G — Tapped Holes

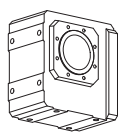
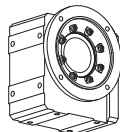
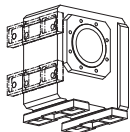

These Housing Styles are available as Hollow (A) or Solid (V) Output.
See page 79 for mounting positions.

Output Shaft Diameter and Hollow Output (inches)

See Page 53 for other options.

Base Module	Output Shaft	Hollow Output	Base Module	Output Shaft	Hollow Output
K102	1.000	1.000	K613/K614	1.750	2.000
K202/K203	1.250	1.187	K713/K714	2.375	2.375
K302/K303	1.250	1.375	K813/K814	2.875	2.750
K402/K403	1.375	1.500	K913/K914	3.625	3.250
K513/K514	1.750	2.000	K1013/K1014	4.375	4.000



"K" Series – MGS Adjustable Speed Drive Selection Data



Speed Range Output RPM ⁽¹⁾		Part Number	Maximum		Transition ⁽²⁾		Minimum	
			RPM	Torque in. lbs.	RPM	Torque in. lbs.	RPM	Torque in. lbs.
Max.	Min.							

3.0 HP, 1750 RPM Motor

Continued next page

216	43	K302_0100	TD470K	180-300	216	752	94	1,742	43	1,742
189	38	K202_0115	TD470K	180-300	189	856	110	1,517	38	1,517
188	38	K302_0115	TD470K	180-300	188	861	82	1,995	38	1,995
172	34	K202_0125	TD470K	180-300	172	942	111	1,513	34	1,513
174	35	K302_0125	TD470K	180-300	174	933	75	2,161	35	2,161
158	32	K202_0140	TD470K	180-300	158	1,027	111	1,511	32	1,511
157	31	K302_0140	TD470K	180-300	157	1,033	68	2,395	31	2,395
150	30	K513_0145	TD470K	180-300	150	1,062	65	2,462	30	2,462
136	27	K513_0160	TD470K	180-300	136	1,176	59	2,726	27	2,726
130	26	K202_0170	TD470K	180-300	130	1,250	109	1,519	26	1,519
129	26	K302_0170	TD470K	180-300	129	1,256	56	2,911	26	2,911
125	25	K202_0175	TD470K	180-300	125	1,295	109	1,521	25	1,521
126	25	K302_0175	TD470K	180-300	126	1,282	55	2,972	25	2,972
126	25	K402_0175	TD470K	180-300	126	1,291	55	2,991	25	2,991
115	23	K613_0190	TD470K	180-300	115	1,388	50	3,217	23	3,217
113	23	K513_0195	TD470K	180-300	113	1,414	49	3,278	23	3,278
108	22	K302_0200	TD470K	180-300	108	1,504	53	3,100	22	3,100
108	22	K402_0200	TD470K	180-300	108	1,498	47	3,471	22	3,471
99	20	K513_0220	TD470K	180-300	99	1,607	43	3,725	20	3,725
94	19	K302_0230	TD470K	180-300	94	1,727	54	3,100	19	3,100
94	19	K402_0230	TD470K	180-300	94	1,727	41	4,003	19	4,003
90	18	K513_0240	TD470K	180-300	90	1,779	39	4,124	18	4,124
87	17	K402_0250	TD470K	180-300	87	1,875	38	4,344	17	4,344
78	16	K302_0280	TD470K	180-300	78	2,068	54	3,100	16	3,100
79	16	K402_0280	TD470K	180-300	79	2,059	34	4,772	16	4,772
75	15	K513_0290	TD470K	180-300	75	2,133	33	4,942	15	4,942
68	14	K513_0320	TD470K	180-300	68	2,361	29	5,472	14	5,472
63	13	K402_0350	TD470K	180-300	63	2,577	34	4,872	13	4,872
63	13	K513_0350	TD470K	180-300	63	2,543	27	5,894	13	5,894
57	11	K613_0380	TD470K	180-300	57	2,801	25	6,490	11	6,490
57	11	K513_0390	TD470K	180-300	57	2,816	25	6,525	11	6,525
51	10	K613_0430	TD470K	180-300	51	3,151	22	7,301	10	7,301
50	10	K513_0440	TD470K	180-300	50	3,179	22	7,367	10	7,367
49	10	K713_0450	TD470K	180-300	49	3,293	21	7,631	10	7,631
45	9.1	K513_0480	TD470K	180-300	45	3,520	20	7,972	9.1	7,972
45	8.9	K813_0490	TD470K	180-300	45	3,580	19	8,297	8.9	8,297
44	8.8	K713_0500	TD470K	180-300	44	3,646	19	8,448	8.8	8,448
38	7.5	K513_0580	TD470K	180-300	38	4,261	21	7,972	7.5	7,972
38	7.6	K613_0580	TD470K	180-300	38	4,206	16	9,746	7.6	9,746
37	7.5	K713_0590	TD470K	180-300	37	4,281	16	9,920	7.5	9,920
34	6.8	K513_0650	TD470K	180-300	34	4,717	21	7,972	6.8	7,972
34	6.9	K613_0640	TD470K	180-300	34	4,656	15	10,790	6.9	10,790

Part No. Explanation

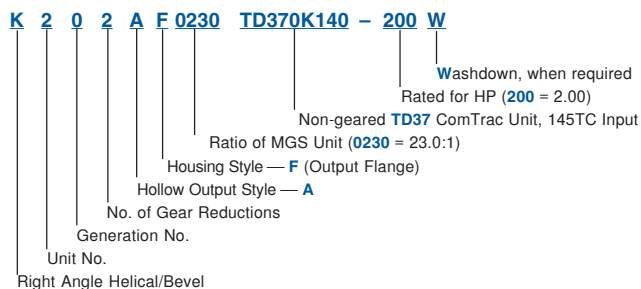

Selection Procedure:

- Determine the MGS/ComTrac combination according to the Input HP of the application and the Output RPM nearest the required **maximum** speed.
- Verify that the output torque will sufficiently meet the application requirements.
- Complete the Part No. per the example by adding "A" or "V" for the Output Style and the Housing Style letter ("N", "F", or "G") as required.



"K" Series – MGS Adjustable Speed Drive Selection Data



Speed Range Output RPM ⁽¹⁾		Part Number	Maximum		Transition ⁽²⁾		Minimum	
			RPM	Torque in.lbs.	RPM	Torque in.lbs.	RPM	Torque in.lbs.
Max.	Min.							

3.0 HP, 1750 RPM Motor Continued

34	6.7	K713_0650	TD470K 180-300	34	4,739	15	10,983	6.7	10,983
32	6.4	K613_0690	TD470K 180-300	32	5,026	14	11,639	6.4	11,639
31	6.1	K713_0710	TD470K 180-300	31	5,204	13	12,059	6.1	12,059
31	6.1	K813_0720	TD470K 180-300	31	5,240	13	12,144	6.1	12,144
29	5.7	K613_0760	TD470K 180-300	29	5,565	13	12,844	5.7	12,844
28	5.6	K713_0790	TD470K 180-300	28	5,761	12	13,351	5.6	13,351
25	4.9	K713_0890	TD470K 180-300	25	6,505	11	14,803	4.9	14,803
25	5.0	K813_0880	TD470K 180-300	25	6,414	11	14,864	5.0	14,864
23	4.5	K813_0970	TD470K 180-300	23	7,101	10	16,457	4.5	16,457
23	4.7	K914_0940	TD470K 180-300	23	6,746	10	15,633	4.7	15,633
22	4.4	K713_0990	TD470K 180-300	22	7,202	10	16,394	4.4	16,394
19	3.8	K714_1150	TD470K 180-300	19	8,251	8.3	19,121	3.8	19,121
17	3.4	K714_1270	TD470K 180-300	17	9,135	7.5	21,170	3.4	21,170
17	3.5	K914_1260	TD470K 180-300	17	9,049	7.5	20,970	3.5	20,970
16	3.2	K714_1390	TD470K 180-300	16	9,985	7.5	21,259	3.2	21,259
15	3.1	K814_1420	TD470K 180-300	15	10,182	6.7	23,596	3.1	23,596
15	2.9	K914_1490	TD470K 180-300	15	10,718	6.4	24,839	2.9	24,839
14	2.8	K714_1540	TD470K 180-300	14	11,055	7.6	21,259	2.8	21,259
14	2.8	K814_1570	TD470K 180-300	14	11,273	6.1	26,124	2.8	26,124
13	2.5	K814_1730	TD470K 180-300	13	12,468	5.5	28,893	2.5	28,893
12	2.5	K714_1760	TD470K 180-300	12	12,694	7.6	21,259	2.5	21,259
11	2.2	K714_1950	TD470K 180-300	11	14,054	7.7	21,259	2.2	21,259
11	2.3	K814_1920	TD470K 180-300	11	13,804	4.9	31,988	2.3	31,988
10	1.9	K714_2290	TD470K 180-300	10	16,502	7.6	21,259	1.9	21,259
9.5	1.9	K814_2310	TD470K 180-300	9	16,647	4.3	37,204	1.9	37,204
8.9	1.8	K914_2470	TD470K 180-300	9	17,771	3.8	41,182	1.8	41,182
8.6	1.7	K714_2540	TD470K 180-300	9	18,271	7.5	21,259	1.7	21,259
8.5	1.7	K814_2560	TD470K 180-300	9	18,430	4.3	37,204	1.7	37,204
7.8	1.6	K814_2810	TD470K 180-300	8	20,202	5.1	31,935	1.6	31,935
7.4	1.5	K914_2940	TD470K 180-300	7	21,133	3.2	48,973	1.5	48,973
7.0	1.4	K814_3110	TD470K 180-300	7	22,367	4.6	35,365	1.4	35,365
5.9	1.2	K914_3740	TD470K 180-300	6	26,883	3.4	47,620	1.2	47,620

5.0 HP, 1750 RPM Motor Continued next page

547	109	K202_0040	TD570K 180-500	547	508	273	1,031	109	1,031
547	109	K302_0040	TD570K 180-500	547	508	273	1,031	109	1,031
501	100	K202_0044	TD570K 180-500	501	554	250	1,125	100	1,125
501	100	K302_0044	TD570K 180-500	501	554	250	1,125	100	1,125
423	85	K202_0052	TD570K 180-500	423	657	244	1,163	85	1,163
407	81	K302_0054	TD570K 180-500	407	683	203	1,386	81	1,386
365	73	K202_0060	TD570K 180-500	365	762	246	1,159	73	1,159
365	73	K302_0060	TD570K 180-500	365	762	182	1,547	73	1,547
327	65	K202_0067	TD570K 180-500	327	849	246	1,160	65	1,160

¹⁾ Speed tolerance at rated load is ±3%. At less than rated load, minimum speed may increase 5%.

²⁾ The ComTrac drive operates at constant horsepower above transition values and at constant torque below transition values. Note shaded area. Engineering advances may cause slight changes to the information shown.

Housing Styles

N — Foot Mounted **F** — Round Flange **G** — Tapped Holes

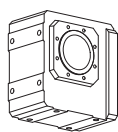
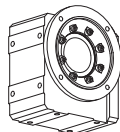
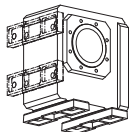

These Housing Styles are available as Hollow (A) or Solid (V) Output.
See page 79 for mounting positions.

Output Shaft Diameter and Hollow Output (inches)

See Page 53 for other options.

Base Module	Output Shaft	Hollow Output	Base Module	Output Shaft	Hollow Output
K102	1.000	1.000	K613/K614	1.750	2.000
K202/K203	1.250	1.187	K713/K714	2.375	2.375
K302/K303	1.250	1.375	K813/K814	2.875	2.750
K402/K403	1.375	1.500	K913/K914	3.625	3.250
K513/K514	1.750	2.000	K1013/K1014	4.375	4.000



"K" Series – MGS Adjustable Speed Drive Selection Data



Speed Range		Part Number	Maximum		Transition ⁽²⁾		Minimum	
Output RPM ⁽¹⁾			RPM	Torque in. lbs.	RPM	Torque in. lbs.	RPM	Torque in. lbs.
Max.	Min.							

5.0 HP, 1750 RPM Motor

Continued next page

325	65	K302_0067	TD570K	180-500	325	856	162	1,737	65	1,737
307	61	K202_0071	TD570K	180-500	307	904	244	1,161	61	1,161
296	59	K302_0074	TD570K	180-500	296	939	148	1,905	59	1,905
293	59	K402_0075	TD570K	180-500	293	947	146	1,922	59	1,922
261	52	K202_0084	TD570K	180-500	261	1,066	240	1,168	52	1,168
259	52	K302_0084	TD570K	180-500	259	1,072	129	2,177	52	2,177
261	52	K402_0084	TD570K	180-500	261	1,064	130	2,159	52	2,159
238	48	K202_0092	TD570K	180-500	238	1,167	237	1,174	48	1,174
237	47	K402_0092	TD570K	180-500	237	1,173	118	2,381	47	2,381
236	47	K302_0093	TD570K	180-500	236	1,177	118	2,389	47	2,389
216	43	K302_0100	TD570K	180-500	216	1,287	108	2,612	43	2,612
217	43	K402_0100	TD570K	180-500	217	1,282	108	2,603	43	2,603
188	38	K302_0115	TD570K	180-500	188	1,474	105	2,696	38	2,696
190	38	K402_0115	TD570K	180-500	190	1,463	95	2,969	38	2,969
174	35	K302_0125	TD570K	180-500	174	1,597	106	2,691	35	2,691
173	35	K402_0125	TD570K	180-500	173	1,607	86	3,263	35	3,263
157	31	K302_0140	TD570K	180-500	157	1,770	106	2,686	31	2,686
158	32	K402_0140	TD570K	180-500	158	1,763	79	3,579	32	3,579
150	30	K513_0145	TD570K	180-500	150	1,819	75	3,693	30	3,693
136	27	K513_0160	TD570K	180-500	136	2,014	68	4,088	27	4,088
129	26	K302_0170	TD570K	180-500	129	2,151	105	2,694	26	2,694
129	26	K402_0170	TD570K	180-500	129	2,151	64	4,366	26	4,366
128	26	K613_0170	TD570K	180-500	128	2,147	64	4,358	26	4,358
126	25	K302_0175	TD570K	180-500	126	2,196	105	2,695	25	2,695
126	25	K402_0175	TD570K	180-500	126	2,210	63	4,486	25	4,486
125	25	K513_0175	TD570K	180-500	125	2,188	62	4,441	25	4,441
115	23	K613_0190	TD570K	180-500	115	2,377	57	4,825	23	4,825
113	23	K513_0195	TD570K	180-500	113	2,422	56	4,917	23	4,917
108	22	K302_0200	TD570K	180-500	108	2,575	103	2,714	22	2,714
108	22	K402_0200	TD570K	180-500	108	2,565	58	4,872	22	4,872
99	20	K513_0220	TD570K	180-500	99	2,752	50	5,587	20	5,587
94	19	K402_0230	TD570K	180-500	94	2,958	58	4,872	19	4,872
90	18	K513_0240	TD570K	180-500	90	3,047	45	6,186	18	6,186
87	17	K402_0250	TD570K	180-500	87	3,210	64	4,434	17	4,434
79	16	K402_0280	TD570K	180-500	79	3,527	59	4,872	16	4,872
75	15	K513_0290	TD570K	180-500	75	3,652	37	7,413	15	7,413
68	14	K513_0320	TD570K	180-500	68	4,043	35	7,972	14	7,972
69	14	K613_0320	TD570K	180-500	69	3,987	34	8,093	14	8,093
63	13	K402_0350	TD570K	180-500	63	4,414	58	4,872	13	4,872
63	13	K513_0350	TD570K	180-500	63	4,355	35	7,972	13	7,972
63	13	K613_0350	TD570K	180-500	63	4,332	32	8,793	13	8,793
57	11	K613_0380	TD570K	180-500	57	4,796	28	9,735	11	9,735
57	11	K513_0390	TD570K	180-500	57	4,822	35	7,972	11	7,972

Part No. Explanation

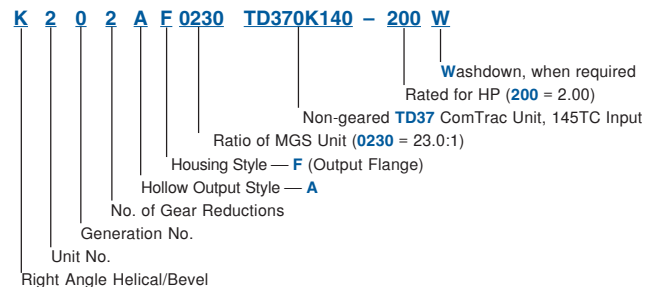

Selection Procedure:

- Determine the MGS/ComTrac combination according to the Input HP of the application and the Output RPM nearest the required **maximum** speed.
- Verify that the output torque will sufficiently meet the application requirements.
- Complete the Part No. per the example by adding "A" or "V" for the Output Style and the Housing Style letter ("N", "F", or "G") as required.



"K" Series – MGS Adjustable Speed Drive Selection Data



Speed Range Output RPM ⁽¹⁾		Part Number	Maximum		Transition ⁽²⁾		Minimum	
			RPM	Torque in.lbs.	RPM	Torque in.lbs.	RPM	Torque in.lbs.
Max.	Min.							

5.0 HP, 1750 RPM Motor

Continued

56	11	K713_0390	TD570K 180-500	56	4,910	28	9,967	11	9,967
51	10	K613_0430	TD570K 180-500	51	5,395	25	10,952	10	10,952
50	10	K513_0440	TD570K 180-500	50	5,444	35	7,972	10	7,972
49	10	K813_0440	TD570K 180-500	49	5,538	25	11,242	10	11,242
49	10	K713_0450	TD570K 180-500	49	5,639	24	11,446	10	11,446
45	9.1	K513_0480	TD570K 180-500	45	6,027	35	7,972	9.1	7,972
46	9.2	K613_0480	TD570K 180-500	46	5,974	23	12,126	9.2	12,126
45	8.9	K813_0490	TD570K 180-500	45	6,131	22	12,446	8.9	12,446
44	8.8	K713_0500	TD570K 180-500	44	6,243	22	12,672	8.8	12,672
38	7.5	K513_0580	TD570K 180-500	38	7,296	35	7,972	7.5	7,972
38	7.6	K613_0580	TD570K 180-500	38	7,202	22	12,844	7.6	12,844
37	7.5	K713_0590	TD570K 180-500	37	7,330	19	14,880	7.5	14,880
34	6.9	K613_0640	TD570K 180-500	34	7,973	22	12,844	6.9	12,844
34	6.7	K713_0650	TD570K 180-500	34	8,116	17	16,474	6.7	16,474
32	6.4	K613_0690	TD570K 180-500	32	8,607	24	11,639	6.4	11,639
31	6.1	K713_0710	TD570K 180-500	31	8,911	15	18,089	6.1	18,089
31	6.1	K813_0720	TD570K 180-500	31	8,974	15	18,215	6.1	18,215
29	5.7	K613_0760	TD570K 180-500	29	9,529	22	12,844	5.7	12,844
28	5.6	K713_0790	TD570K 180-500	28	9,866	14	20,027	5.6	20,027
25	4.9	K713_0890	TD570K 180-500	25	11,139	19	14,803	4.9	14,803
25	4.9	K714_0890	TD570K 180-500	25	10,971	13	21,259	4.9	21,259
25	5.0	K813_0880	TD570K 180-500	25	10,984	12	22,296	5.0	22,296
23	4.5	K813_0970	TD570K 180-500	23	12,161	11	24,685	4.5	24,685
23	4.7	K914_0940	TD570K 180-500	23	11,552	12	23,450	4.7	23,450
22	4.4	K713_0990	TD570K 180-500	22	12,333	17	16,394	4.4	16,394
22	4.4	K714_0990	TD570K 180-500	22	12,147	13	21,259	4.4	21,259
19	3.8	K714_1150	TD570K 180-500	19	14,130	13	21,259	3.8	21,259
19	3.8	K814_1150	TD570K 180-500	19	14,115	10	28,652	3.8	28,652
17	3.4	K714_1270	TD570K 180-500	17	15,644	13	21,259	3.4	21,259
17	3.4	K814_1270	TD570K 180-500	17	15,627	8.6	31,722	3.4	31,722
17	3.5	K914_1260	TD570K 180-500	17	15,496	8.7	31,455	3.5	31,455
16	3.2	K714_1390	TD570K 180-500	16	17,098	13	21,259	3.2	21,259
15	3.1	K814_1420	TD570K 180-500	15	17,436	7.7	35,393	3.1	35,393
15	2.9	K914_1490	TD570K 180-500	15	18,355	7.3	37,258	2.9	37,258
14	2.8	K714_1540	TD570K 180-500	14	18,930	13	21,259	2.8	21,259
14	2.8	K814_1570	TD570K 180-500	14	19,304	7.4	37,204	2.8	37,204
13	2.5	K814_1730	TD570K 180-500	13	21,350	7.4	37,204	2.5	37,204
11	2.3	K814_1920	TD570K 180-500	11	23,638	7.4	37,204	2.3	37,204
11	2.3	K914_1920	TD570K 180-500	11	23,612	5.7	47,929	2.3	47,929
9.5	1.9	K814_2310	TD570K 180-500	9.5	28,506	7.4	37,204	1.9	37,204
8.9	1.8	K914_2470	TD570K 180-500	8.9	30,431	5.2	53,194	1.8	53,194
8.5	1.7	K814_2560	TD570K 180-500	8.5	31,561	7.4	37,204	1.7	37,204
7.4	1.5	K914_2940	TD570K 180-500	7.4	36,189	5.4	51,585	1.5	51,585
5.9	1.2	K914_3740	TD570K 180-500	5.9	46,035	5.7	47,620	1.2	47,620

¹⁾ Speed tolerance at rated load is ±3%. At less than rated load, minimum speed may increase 5%.

²⁾ The ComTrac drive operates at constant horsepower above transition values and at constant torque below transition values. Note shaded area. Engineering advances may cause slight changes to the information shown.

Housing Styles

N — Foot Mounted **F** — Round Flange **G** — Tapped Holes

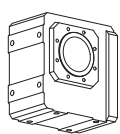
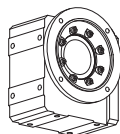
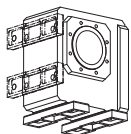

These Housing Styles are available as Hollow (A) or Solid (V) Output.
See page 79 for mounting positions.

Output Shaft Diameter and Hollow Output (inches)

See Page 53 for other options.

Base Module	Output Shaft	Hollow Output	Base Module	Output Shaft	Hollow Output
K102	1.000	1.000	K613/K614	1.750	2.000
K202/K203	1.250	1.187	K713/K714	2.375	2.375
K302/K303	1.250	1.375	K813/K814	2.875	2.750
K402/K403	1.375	1.500	K913/K914	3.625	3.250
K513/K514	1.750	2.000	K1013/K1014	4.375	4.000



"K" Series – MGS Adjustable Speed Drive Selection Data



Speed Range Output RPM ⁽¹⁾		Part Number	Maximum		Transition ⁽²⁾		Minimum	
			RPM	Torque in.lbs.	RPM	Torque in.lbs.	RPM	Torque in.lbs.
Max.	Min.							

7.5 HP, 1750 RPM Motor

Continued next page

547	109	K402_0040	TD670K 210-750	547	755	298	1,409	109	1,409
501	100	K402_0044	TD670K 210-750	501	824	273	1,537	100	1,537
403	81	K402_0054	TD670K 210-750	403	1,023	220	1,910	81	1,910
365	73	K402_0060	TD670K 210-750	365	1,132	199	2,114	73	2,114
326	65	K402_0067	TD670K 210-750	326	1,268	177	2,367	65	2,367
293	59	K402_0075	TD670K 210-750	293	1,407	160	2,627	59	2,627
261	52	K402_0084	TD670K 210-750	261	1,581	142	2,951	52	2,951
237	47	K402_0092	TD670K 210-750	237	1,744	129	3,254	47	3,254
217	43	K402_0100	TD670K 210-750	217	1,906	118	3,557	43	3,557
190	38	K402_0115	TD670K 210-750	190	2,174	104	4,058	38	4,058
189	38	K513_0115	TD670K 210-750	189	2,152	103	4,017	38	4,017
173	35	K402_0125	TD670K 210-750	173	2,389	104	4,059	35	4,059
173	35	K613_0125	TD670K 210-750	173	2,349	94	4,385	35	4,385
171	34	K513_0130	TD670K 210-750	171	2,383	93	4,447	34	4,447
158	32	K402_0140	TD670K 210-750	158	2,621	105	4,050	32	4,050
150	30	K513_0145	TD670K 210-750	150	2,704	82	5,047	30	5,047
136	27	K513_0160	TD670K 210-750	136	2,994	74	5,587	27	5,587
129	26	K402_0170	TD670K 210-750	129	3,197	104	4,059	26	4,059
128	26	K613_0170	TD670K 210-750	128	3,191	70	5,957	26	5,957
126	25	K402_0175	TD670K 210-750	126	3,285	104	4,063	25	4,063
125	25	K513_0175	TD670K 210-750	125	3,252	68	6,069	25	6,069
120	24	K713_0185	TD670K 210-750	120	3,400	65	6,345	24	6,345
115	23	K613_0190	TD670K 210-750	115	3,533	63	6,595	23	6,595
113	23	K513_0195	TD670K 210-750	113	3,600	62	6,719	23	6,719
108	22	K713_0200	TD670K 210-750	108	3,764	59	7,025	22	7,025
99	20	K513_0220	TD670K 210-750	99	4,091	54	7,636	20	7,636
96	19	K713_0230	TD670K 210-750	96	4,230	52	7,895	19	7,895
90	18	K513_0240	TD670K 210-750	90	4,529	52	7,972	18	7,972
91	18	K613_0240	TD670K 210-750	91	4,466	50	8,335	18	8,335
87	17	K713_0250	TD670K 210-750	87	4,683	47	8,741	17	8,741
86	17	K813_0260	TD670K 210-750	86	4,746	47	8,858	17	8,858
75	15	K513_0290	TD670K 210-750	75	5,428	52	7,972	15	7,972
76	15	K613_0290	TD670K 210-750	76	5,352	41	9,990	15	9,990
68	14	K513_0320	TD670K 210-750	68	6,010	52	7,972	14	7,972
69	14	K613_0320	TD670K 210-750	69	5,926	37	11,060	14	11,060
63	13	K613_0350	TD670K 210-750	63	6,438	34	12,017	13	12,017
62	12	K713_0350	TD670K 210-750	62	6,592	34	12,304	12	12,304

Part No. Explanation

Selection Procedure:

- Determine the MGS/ComTrac combination according to the Input HP of the application and the Output RPM nearest the required **maximum** speed.
- Verify that the output torque will sufficiently meet the application requirements.
- Complete the Part No. per the example by adding "A" or "V" for the Output Style and the Housing Style letter ("N", "F", or "G") as required.

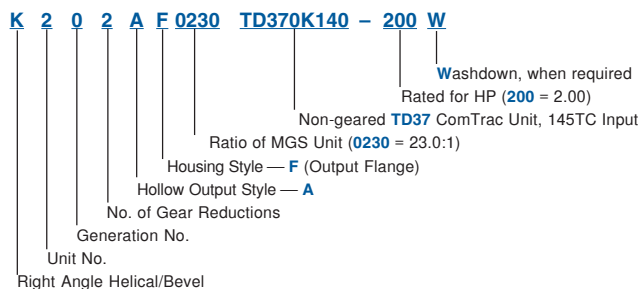



"K" Series – MGS Adjustable Speed Drive Selection Data



Speed Range Output RPM ⁽¹⁾		Part Number	Maximum		Transition ⁽²⁾		Minimum	
			RPM	Torque in.lbs.	RPM	Torque in.lbs.	RPM	Torque in.lbs.
Max.	Min.							

7.5 HP, 1750 RPM Motor

Continued

61	12	K813_0360	TD670K 210-750	61	6,723	33	12,547	12	12,547
57	11	K613_0380	TD670K 210-750	57	7,128	32	12,844	11	12,844
58	12	K913_0380	TD670K 210-750	58	7,077	31	13,208	12	13,208
56	11	K713_0390	TD670K 210-750	56	7,298	30	13,622	11	13,622
55	11	K813_0400	TD670K 210-750	55	7,443	30	13,891	11	13,891
49	10	K813_0440	TD670K 210-750	49	8,232	27	15,364	10	15,364
49	10	K713_0450	TD670K 210-750	49	8,381	26	15,643	10	15,643
45	8.9	K813_0490	TD670K 210-750	45	9,114	24	17,010	8.9	17,010
44	8.8	K713_0500	TD670K 210-750	44	9,279	24	17,319	8.8	17,319
37	7.5	K713_0590	TD670K 210-750	37	10,895	20	20,335	7.5	20,335
35	6.9	K913_0630	TD670K 210-750	35	11,733	19	21,898	6.9	21,898
34	6.7	K713_0650	TD670K 210-750	34	12,063	20	21,259	6.7	21,259
33	6.7	K813_0650	TD670K 210-750	33	12,168	18	22,711	6.7	22,711
33	6.5	K814_0670	TD670K 210-750	33	12,238	18	22,840	6.5	22,840
31	6.1	K813_0720	TD670K 210-750	31	13,338	17	24,894	6.1	24,894
30	5.9	K814_0740	TD670K 210-750	30	13,549	16	25,287	5.9	25,287
29	5.8	K913_0750	TD670K 210-750	29	13,953	16	26,041	5.8	26,041
28	5.5	K813_0790	TD670K 210-750	28	14,767	15	27,562	5.5	27,562
25	4.9	K814_0890	TD670K 210-750	25	16,275	13	30,376	4.9	30,376
24	4.7	K914_0920	TD670K 210-750	24	16,910	13	31,561	4.7	31,561
23	4.6	K913_0950	TD670K 210-750	23	17,749	12	33,127	4.6	33,127
22	4.4	K814_0980	TD670K 210-750	22	18,019	12	33,631	4.4	33,631
19	3.9	K814_1130	TD670K 210-750	19	20,661	11	37,204	3.9	37,204
18	3.5	K814_1250	TD670K 210-750	18	22,875	11	37,204	3.5	37,204
18	3.5	K914_1240	TD670K 210-750	18	22,683	10	42,335	3.5	42,335
18	3.6	K1014_1220	TD670K 210-750	18	22,272	10	41,569	3.6	41,569
16	3.1	K814_1390	TD670K 210-750	16	25,523	11	37,204	3.1	37,204
15	3.0	K914_1470	TD670K 210-750	15	26,868	8.1	50,146	3.0	50,146
15	2.9	K1014_1490	TD670K 210-750	15	27,262	8.0	50,883	2.9	50,883
14	2.8	K814_1540	TD670K 210-750	14	28,257	11	37,204	2.8	37,204
13	2.6	K814_1710	TD670K 210-750	13	31,252	11	37,204	2.6	37,204
12	2.3	K814_1890	TD670K 210-750	12	34,601	11	37,204	2.3	37,204
12	2.3	K914_1890	TD670K 210-750	12	34,563	6.6	62,006	2.3	62,006
12	2.3	K1014_1870	TD670K 210-750	12	34,284	6.4	63,988	2.3	63,988
9.2	1.8	K1014_2370	TD670K 210-750	9	43,473	5.0	81,138	1.8	81,138
9.0	1.8	K914_2430	TD670K 210-750	9	44,545	6.6	62,006	1.8	62,006
7.5	1.5	K1014_2900	TD670K 210-750	8	53,165	4.1	99,227	1.5	99,227

¹⁾ Speed tolerance at rated load is ±3%. At less than rated load, minimum speed may increase 5%.

²⁾ The ComTrac drive operates at constant horsepower above transition values and at constant torque below transition values. Note shaded area. Engineering advances may cause slight changes to the information shown.

Housing Styles

N — Foot Mounted **F** — Round Flange **G** — Tapped Holes

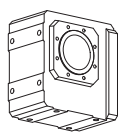
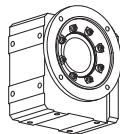
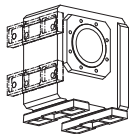

These Housing Styles are available as Hollow (A) or Solid (V) Output.
See page 79 for mounting positions.

Output Shaft Diameter and Hollow Output (inches)

See Page 53 for other options.

Base Module	Output Shaft	Hollow Output	Base Module	Output Shaft	Hollow Output
K102	1.000	1.000	K613/K614	1.750	2.000
K202/K203	1.250	1.187	K713/K714	2.375	2.375
K302/K303	1.250	1.375	K813/K814	2.875	2.750
K402/K403	1.375	1.500	K913/K914	3.625	3.250
K513/K514	1.750	2.000	K1013/K1014	4.375	4.000



"K" Series – MGS Adjustable Speed Drive Selection Data



Speed Range		Part Number	Maximum		Transition ⁽²⁾		Minimum	
Output RPM ⁽¹⁾			RPM	Torque in. lbs.	RPM	Torque in. lbs.	RPM	Torque in. lbs.
Max.	Min.							

10.0 HP, 1750 RPM Motor

131	26	K613_0170	TD760K 210-1000	131	4,324	70	8,136	26	8,136
130	26	K813_0175	TD760K 210-1000	130	4,367	69	8,217	26	8,217
123	25	K713_0185	TD760K 210-1000	123	4,606	65	8,666	25	8,666
118	24	K613_0190	TD760K 210-1000	118	4,788	63	9,007	24	9,007
111	22	K713_0200	TD760K 210-1000	111	5,100	59	9,595	22	9,595
104	21	K613_0220	TD760K 210-1000	104	5,466	55	10,283	21	10,283
99	20	K713_0230	TD760K 210-1000	99	5,732	52	10,783	20	10,783
94	19	K613_0240	TD760K 210-1000	94	6,051	50	11,385	19	11,385
89	18	K713_0250	TD760K 210-1000	89	6,346	47	11,939	18	11,939
88	18	K813_0260	TD760K 210-1000	88	6,431	47	12,099	18	12,099
78	16	K613_0290	TD760K 210-1000	78	7,252	44	12,844	16	12,844
77	15	K713_0290	TD760K 210-1000	77	7,382	41	13,888	15	13,888
71	14	K613_0320	TD760K 210-1000	71	8,029	45	12,844	14	12,844
69	14	K713_0320	TD760K 210-1000	69	8,173	37	15,376	14	15,376
65	13	K613_0350	TD760K 210-1000	65	8,724	45	12,844	13	12,844
63	13	K713_0350	TD760K 210-1000	63	8,932	34	16,805	13	16,805
62	12	K813_0360	TD760K 210-1000	62	9,109	33	17,137	12	17,137
59	12	K613_0380	TD760K 210-1000	59	9,659	45	12,844	12	12,844
59	12	K913_0380	TD760K 210-1000	59	9,589	31	18,040	12	18,040
57	11	K713_0390	TD760K 210-1000	57	9,889	30	18,606	11	18,606
56	11	K813_0400	TD760K 210-1000	56	10,085	30	18,973	11	18,973
51	10	K813_0440	TD760K 210-1000	51	11,154	27	20,984	10	20,984
50	10	K713_0450	TD760K 210-1000	50	11,356	27	21,259	10	21,259
46	9.2	K813_0490	TD760K 210-1000	46	12,349	24	23,233	9.2	23,233
45	9.0	K713_0500	TD760K 210-1000	45	12,573	27	21,259	9.0	21,259
38	7.7	K713_0590	TD760K 210-1000	38	14,763	27	21,259	7.7	21,259
38	7.6	K813_0590	TD760K 210-1000	38	14,892	20	28,018	7.6	28,018
36	7.1	K913_0630	TD760K 210-1000	36	15,898	19	29,910	7.1	29,910
37	7.3	K1013_0620	TD760K 210-1000	37	15,515	19	29,190	7.3	29,190
35	6.9	K713_0650	TD760K 210-1000	35	16,345	27	21,259	6.9	21,259
34	6.9	K813_0650	TD760K 210-1000	34	16,488	18	31,020	6.9	31,020
31	6.3	K813_0720	TD760K 210-1000	31	18,073	18	31,935	6.3	31,935
30	6.0	K913_0750	TD760K 210-1000	30	18,905	16	35,569	6.0	35,569
28	5.7	K813_0790	TD760K 210-1000	28	20,009	16	35,365	5.7	35,365
24	4.7	K913_0950	TD760K 210-1000	24	24,049	13	45,246	4.7	45,246
24	4.8	K1013_0940	TD760K 210-1000	24	23,776	13	44,733	4.8	44,733
24	4.8	K1014_0930	TD760K 210-1000	24	23,159	13	43,571	4.8	43,571
18	3.6	K1014_1240	TD760K 210-1000	18	30,694	10	57,748	3.6	57,748
15	3.0	K1014_1510	TD760K 210-1000	15	37,572	7.9	70,687	3.0	70,687
12	2.4	K1014_1900	TD760K 210-1000	12	47,248	6.3	88,892	2.4	88,892

Part No. Explanation

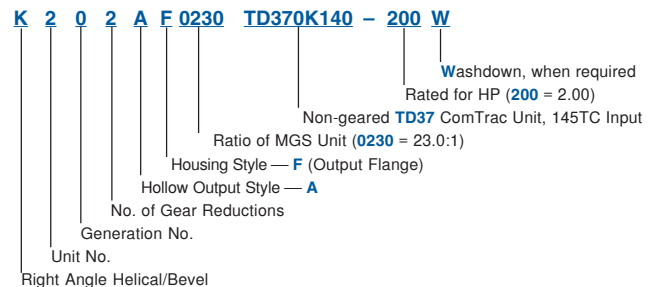

Selection Procedure:

- Determine the MGS/ComTrac combination according to the Input HP of the application and the Output RPM nearest the required **maximum** speed.
- Verify that the output torque will sufficiently meet the application requirements.
- Complete the Part No. per the example by adding "A" or "V" for the Output Style and the Housing Style letter ("N", "F", or "G") as required.



"K" Series – MGS® Adjustable Speed Drives

Dimensional Data

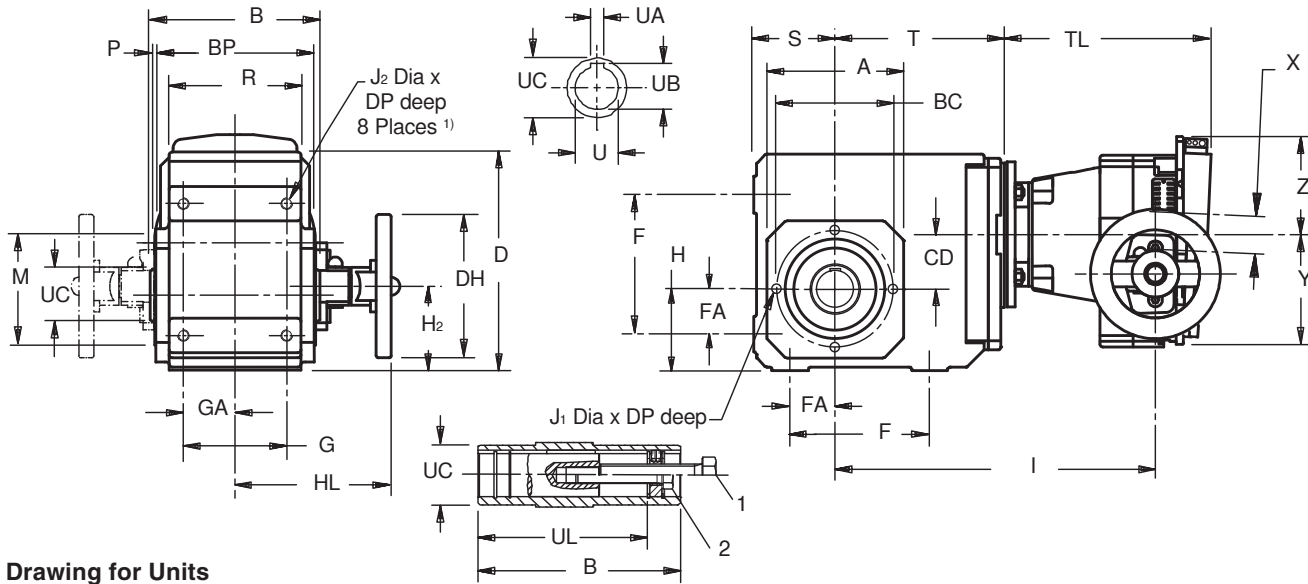

Drawing for Units
K102AG – K403AG

Table No. 1 "K" Series – Tapped Hole Unit Dimensions (Inches) – "G" Housing Style

Base Module	A	B	D	F	G	H	M	Tolerance	P	R	S	Z ₁	BC	BP	FA	GA
K102	4.13	4.72	6.30	3.54	2.76	2.36	2.953	+0.007/-0.005	.12	3.54	2.36	—	3.54	4.41	1.18	1.38
K202/203	4.57	5.83	7.48	4.53	3.54	2.56	3.228	+0.007/-0.005	.12	4.53	2.56	—	3.94	5.28	1.38	1.77
K302/303	5.20	6.30	8.39	5.12	4.13	2.95	3.740	+0.007/-0.005	.12	5.12	2.95	—	4.53	5.75	1.57	2.07
K402/403	5.98	7.40	9.45	6.10	4.72	3.54	4.331	+0.007/-0.005	.14	5.83	3.54	—	5.12	6.81	1.97	2.36
K513/514	5.71	7.87	10.24	5.51	4.92	6.30	4.331	+0.007/-0.005	.14	6.30	3.94	5.98	5.12	7.28	1.57	2.46
K613/614	7.09	8.46	12.20	6.30	5.12	7.48	5.512	+0.008/-0.006	.14	6.61	4.72	6.77	6.50	7.87	1.97	2.56
K713/714	7.68	9.53	13.46	7.09	5.71	8.35	6.102	+0.008/-0.006	.14	7.48	4.92	7.52	7.28	8.90	2.17	2.85
K813/814	8.90	11.81	16.14	9.45	7.28	10.43	7.283	+0.010/-0.007	.16	9.25	5.71	8.11	8.46	11.10	2.95	3.64
K913/914	11.02	13.78	19.49	11.02	8.86	12.40	9.055	+0.010/-0.007	.20	11.22	7.09	9.84	10.43	12.99	3.74	4.43
K1013/K1014	13.39	16.14	23.27	13.78	12.99	14.76	9.646	+0.012/-0.008	.79	15.60	8.86	12.01	11.81	14.02	4.53	6.50

Table No. 2 "K" Series Bore Dimensions and Mounting Holes (Inches)

Base Module	U	Tolerance	UA	UB	UC	UL	1	J ₁ ×DP	J ₂ ×DP
K102	1.0000	+0.008/-0.0000	.250	1.11	1.57	3.86	1/2-13	4, M8×.51	M8×.51 ¹⁾
K202/203	1.1875	+0.010/-0.0000	.250	1.31	1.77	4.78	1/2-13	4, M8×.51	M10×.63
K302/303	1.3750	+0.010/-0.0000	.312	1.52	1.97	4.92	5/8-11	4, M8×.51	M10×.63
K402/403	1.5000	+0.010/-0.0000	.375	1.67	2.17	6.18	3/4-10	4, M10×.63	M12×.75
K513/514	2.0000	+0.012/-0.0000	.500	2.13	2.56	6.46	3/4-10	8, M10×.63	M16×1.02
K613/614	2.0000	+0.012/-0.0000	.500	2.23	2.76	7.05	3/4-10	8, M10×.63	M16×1.02
K713/714	2.3750	+0.012/-0.0000	.625	2.66	3.35	8.43	1-8	8, M12×.75	M20×1.22
K813/814	2.7500	+0.012/-0.0000	.625	3.03	3.94	10.35	1-8	8, M12×.75	M24×1.50
K913/914	3.2500	+0.014/-0.0000	.750	3.59	4.33	11.89	1-8	8, M16×1.02	M30×1.89
K1013/K1014	4.0000	+0.014/-0.0000	1.000	4.311	5.12	14.25	1 1/4-7	10, M20×1.30	1.54×1.77 ²⁾

Table No. 3 "K" Series – Unit Dimensions (Inches)

ComTrac Part No.	NEMA C-Flange	DH	HL	TL	X	Y	Z
TD270K050	56C	4.92	5.67	7.87	2.09	5.55	4.41
TD270K140	143/145TC	4.92	5.67	7.87	2.09	5.55	4.41
TD370K140	143/145TC	4.92	5.91	8.50	2.17	5.67	4.37
TD470K180	182/184TC	6.30	6.81	8.94	2.80	7.20	5.59
TD570K180	182/184TC	7.87	8.31	11.89	3.11	8.11	6.30
TD670K210	213/215TC	7.87	9.17	12.17	3.86	9.02	7.13
TD760K210	213/215TC	9.84	9.72	14.25	4.29	9.37	7.68

(1) Tapped hole are located on Side 2 of K1 units ONLY.
(2) This dimension is a clearance hole. The mounting feet are an integral part of the K10 housing.

Part No. Example

Hollow Output — Tapped Hole Unit with ComTrac
K402AG0350 TD470K180-300



"K" Series – MGS® Adjustable Speed Drives Dimensional Data

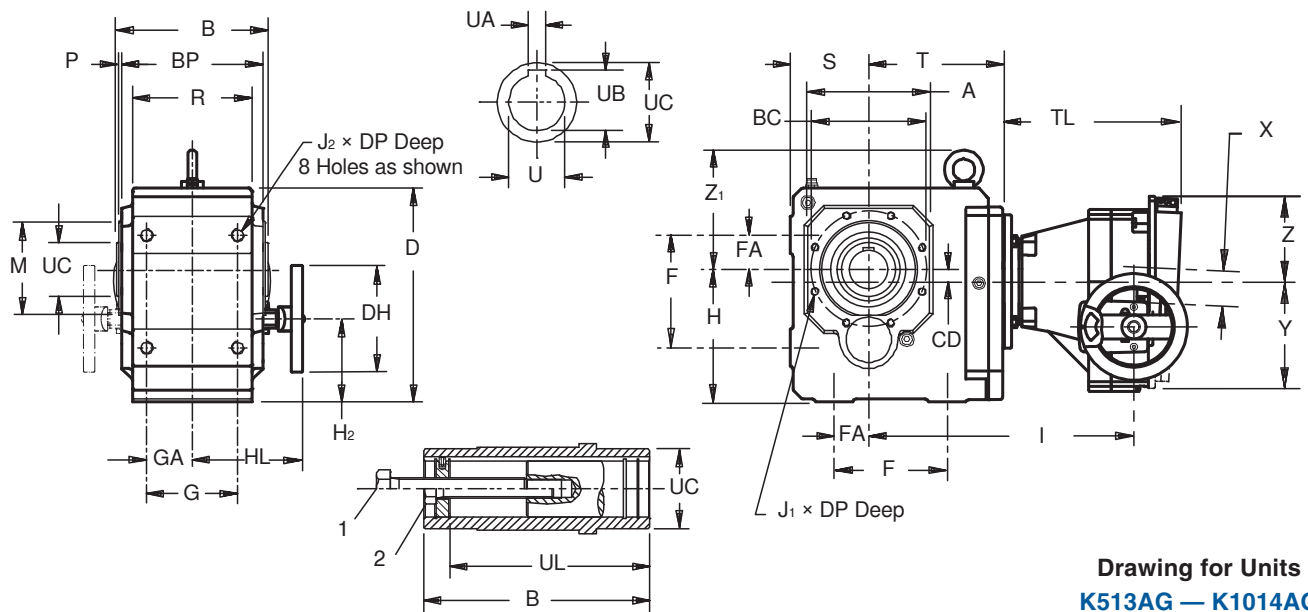

**Drawing for Units
K513AG – K1014G**

Table No. 4 "K" Series – Tapped Hole Unit Dimensions (Inches) – "G" Housing Style

Base Module	CD	TD270K050 ⁽³⁾			TD370K140			TD470K180			TD570K180			TD670K210			TD760K210		
		H ₂	I	T	H ₂	I	T	H ₂	I	T	H ₂	I	T	H ₂	I	T	H ₂	I	T
K102	1.42	2.20	7.87	5.04	1.73	8.50	5.04	—	—	—	—	—	—	—	—	—	—	—	—
K202	1.81	2.80	11.97	5.79	2.32	12.64	5.79	1.17	12.76	5.87	—	—	—	—	—	—	—	—	—
K203	1.81	—	—	—	—	—	—	—	—	—	—	—	—	—	—	—	—	—	—
K302	2.07	3.44	12.76	6.57	2.97	13.43	6.57	2.42	13.54	6.65	1.67	16.18	6.65	—	—	—	—	—	—
K303	.63	2.01	14.45	8.27	1.54	15.12	8.27	—	—	—	—	—	—	—	—	—	—	—	—
K402	2.36	—	—	—	3.86	14.21	7.36	3.31	14.33	7.44	2.56	16.97	7.44	2.36	17.28	7.56	—	—	—
K403	.91	2.87	15.24	9.06	2.40	15.91	9.06	—	—	—	—	—	—	—	—	—	—	—	—
K513	.59	—	—	—	3.66	13.62	6.77	3.11	13.74	6.85	2.36	16.38	6.85	2.17	16.69	6.97	—	—	—
K514	.59	4.13	14.65	8.46	3.66	15.31	8.46	—	—	—	—	—	—	—	—	—	—	—	—
K613	.71	—	—	—	—	—	—	4.17	14.49	7.60	3.43	17.13	7.60	3.23	17.44	7.72	3.23	19.88	8.27
K614	.71	5.20	15.39	9.21	4.72	16.06	9.21	—	—	—	—	—	—	—	—	—	—	—	—
K713	.79	—	—	—	—	—	—	4.96	15.59	8.70	4.21	18.23	8.70	4.02	18.54	8.82	4.02	20.94	9.33
K714	.79	5.98	16.54	10.35	5.51	17.20	10.35	4.96	18.03	11.14	4.21	20.67	11.14	—	—	—	—	—	—
K813	.94	—	—	—	—	—	—	—	—	—	6.14	19.25	9.72	5.94	19.53	9.80	5.94	21.93	10.31
K814	.94	—	—	—	—	—	—	6.89	19.02	12.13	6.14	21.65	12.13	—	—	—	—	—	—
K913	.98	—	—	—	—	—	—	—	—	—	—	—	—	7.87	21.30	11.57	7.87	23.70	12.09
K914	.98	—	—	—	—	—	—	8.82	20.79	13.90	8.07	23.43	13.90	7.87	24.09	14.37	—	—	—
K1013	1.10	—	—	—	—	—	—	—	—	—	—	—	—	—	—	—	10.11	14.25	15.43
K1014	1.10	—	—	—	—	—	—	—	—	—	—	—	—	10.11	12.16	17.72	10.11	14.25	18.70

Table No. 5 "K" Series with ComTrac – Approximate Weight (lbs.)

Part Number	K102	K202	K302	K303	K402	K403	K513	K514	K613	K614	K713	K714	K813	K814	K913	K914	K1013	K1014
TD270K050 ⁽³⁾	64	73	100	106	—	133	—	142	—	210	—	267	—	—	—	—	—	—
TD370K140	82	91	118	124	144	151	157	160	—	228	—	285	—	—	—	—	—	—
TD470K180	—	99	126	—	152	—	165	—	229	—	280	293	—	390	—	589	—	—
TD570K180	—	—	155	—	181	—	184	—	258	—	309	322	397	410	—	618	—	—
TD670K210	—	—	—	—	223	—	236	—	300	—	351	—	439	—	638	660	—	1123
TD760K210	—	—	—	—	—	—	—	—	364	—	415	—	503	—	702	—	1107	1187

⁽³⁾Also available as TD270K140 for a NEMA 143TC frame motor.



"K" Series – MGS® Adjustable Speed Drives Dimensional Data

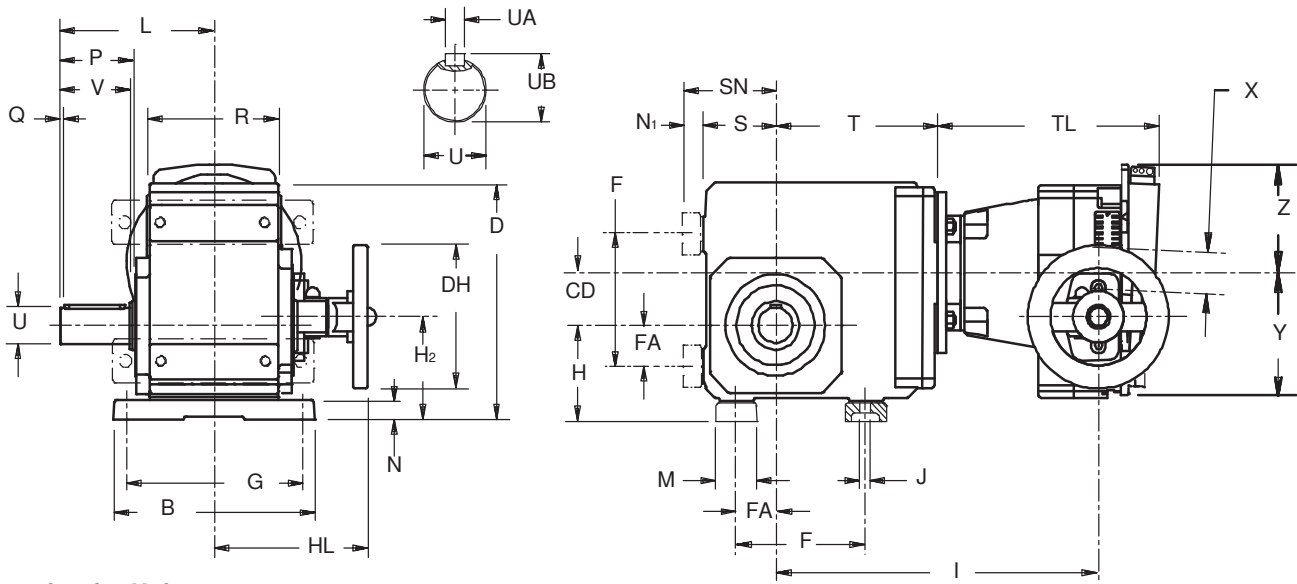

Drawing for Units
K102VN — K403VN

Table No. 1 "K" Series – Foot Mounting Unit Dimensions (Inches) – "N" Housing Style

Base Module	B	D	F	G	H	J	L	M	N	O	P	Q	R	S	Z ₁	BO	FA	N ₁	SN
K102	5.51 ⁽¹⁾	6.97	3.54	4.53	2.95	.35	4.53	1.18	.51	—	2.34	.16	3.54	2.36	—	—	1.18	.59	2.95
K202/203	7.28	8.39	4.53	6.10	3.46	.43	5.31	1.57	.79	—	2.56	.16	4.53	2.56	—	—	1.38	.91	3.46
K302/303	7.87	9.29	5.12	6.69	3.86	.43	5.59	1.77	.79	—	2.60	.16	5.12	2.95	—	—	1.57	.91	3.86
K402/403	9.06	10.43	6.10	7.87	4.53	.55	6.54	1.97	.87	—	3.39	.16	5.83	3.54	—	—	1.97	.98	4.53
K513/514	9.45	11.42	5.51	7.87	7.48	.71	8.74	2.36	1.06	5.10	3.90	.16	6.30	3.94	5.98	7.28	1.57	1.18	5.12
K613/614	9.84	13.39	6.30	8.27	8.66	.71	9.29	2.56	1.06	5.35	4.31	.16	6.61	4.72	6.77	7.87	1.97	1.18	5.91
K713/714	11.42	14.96	7.09	9.45	9.84	.87	10.91	2.76	1.38	6.46	5.14	.16	7.48	4.92	7.52	8.90	2.17	1.50	6.42
K813/814	14.17	17.91	9.45	11.81	12.20	1.02	12.83	3.35	1.61	7.28	5.94	.20	9.25	5.71	8.11	11.10	2.95	1.77	7.48
K913/914	16.93	21.46	11.02	14.17	14.37	1.30	15.16	3.74	1.81	8.66	7.13	.31	11.22	7.09	9.84	12.99	3.74	1.97	9.06
K1013/K1014	15.75 ⁽¹⁾	23.27	12.99	13.78	14.76	1.54	16.46	4.72	1.77	9.45	8.66	.59	15.75	8.86	12.01	15.75	6.10	1.77	8.86

Table No. 2 "K" Series – Shaft Dimensions (Inches)

Base Module	U	Tolerance	V	UA—Key	UB
K102	1.0000	+0.0000/-0.0006	1.97	1/4 × 1/4 × 1 1/2	1.11
K202/203	1.2500	+0.0000/-0.0007	2.36	1/4 × 1/4 × 1 15/16	1.36
K302/303	1.2500	+0.0000/-0.0007	2.36	1/4 × 1/4 × 1 15/16	1.36
K402/403	1.3750	+0.0000/-0.0007	2.76	5/16 × 5/16 × 2 5/16	1.51
K513/514	1.7500	+0.0000/-0.0007	3.54	3/8 × 3/8 × 3 5/32	1.92
K613/614	1.7500	+0.0000/-0.0007	3.94	3/8 × 3/8 × 3 5/32	1.92
K713/714	2.3750	+0.0000/-0.0008	4.72	5/8 × 5/8 × 3 15/16	2.65
K813/814	2.8750	+0.0000/-0.0008	5.51	3/4 × 3/4 × 4 5/16	3.21
K913/914	3.6250	+0.0000/-0.0009	6.69	7/8 × 7/8 × 5 1/2	4.01
K1013/K1014	4.3750	+0.0000/-0.0009	8.27	1 × 1 × 7	4.82

⁽¹⁾ Mounting feet can be bolted to Side 2 of K1 units ONLY.
Mounting feet are an integral part of the K10 housing.

Part No. Example
Foot Mounting Unit with ComTrac
K402VN0350 TD470K180-300

Table No. 3 "K" Series – Unit Dimensions (Inches)

ComTrac Part No.	NEMA C-Flange	DH	HL	TL	X	Y	Z
TD270K050	56C	4.92	5.67	7.87	2.09	5.55	4.41
TD270K140	143/145TC	4.92	5.67	7.87	2.09	5.55	4.41
TD370K140	143/145TC	4.92	5.91	8.50	2.17	5.67	4.37
TD470K180	182/184TC	6.30	6.81	8.94	2.80	7.20	5.59
TD570K180	182/184TC	7.87	8.31	11.89	3.11	8.11	6.30
TD670K210	213/215TC	7.87	9.17	12.17	3.86	9.02	7.13
TD760K210	213/215TC	9.84	9.72	14.25	4.29	9.37	7.68



"K" Series – MGS® Adjustable Speed Drives

Dimensional Data

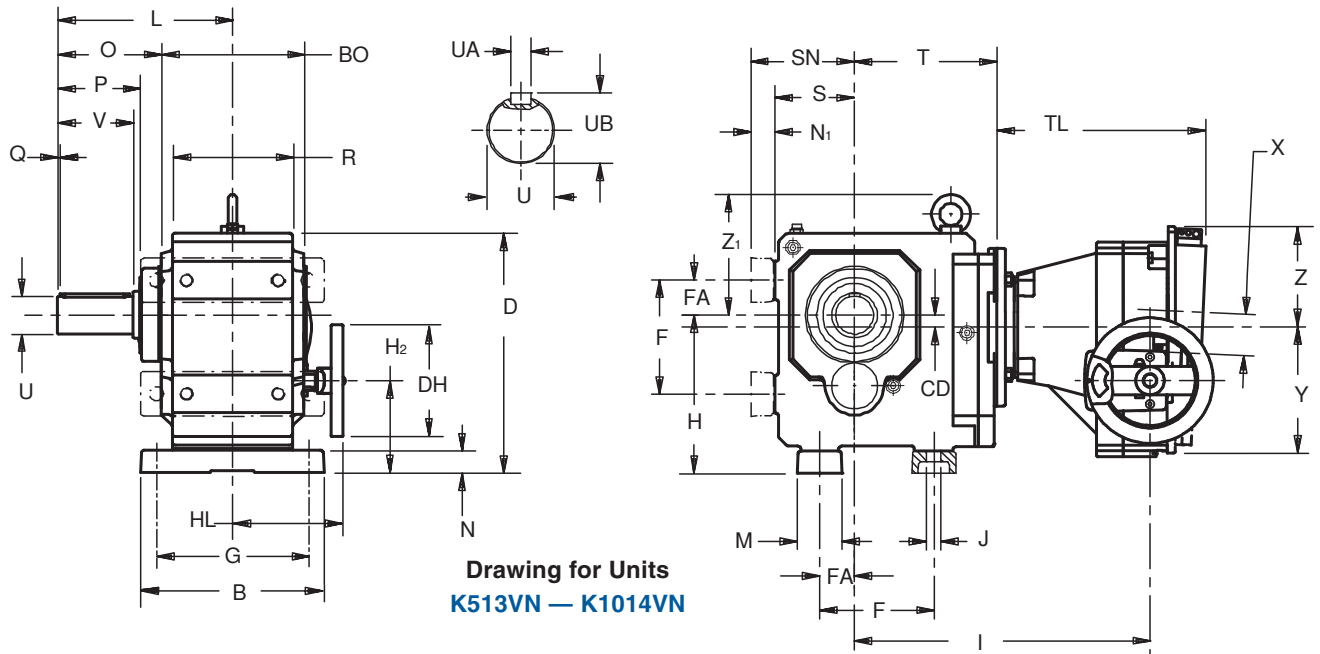

Table No. 4 "K" Series – Unit Dimensions (Inches) – "N" Housing Style

Base	CD	TD270K050 ⁽³⁾			TD370K140			TD470K180			TD570K180			TD670K210			TD760K210		
		H ₂	I	T	H ₂	I	T	H ₂	I	T	H ₂	I	T	H ₂	I	T	H ₂	I	T
K102	1.42	2.20	7.87	5.04	1.73	8.50	5.04	—	—	—	—	—	—	—	—	—	—	—	—
K202	1.81	2.80	11.97	5.79	2.32	12.64	5.79	1.17	12.76	5.87	—	—	—	—	—	—	—	—	—
K203	1.81	—	—	—	—	—	—	—	—	—	—	—	—	—	—	—	—	—	—
K302	2.07	3.44	12.76	6.57	2.97	13.43	6.57	2.42	13.54	6.65	1.67	16.18	6.65	—	—	—	—	—	—
K303	.63	2.01	14.45	8.27	1.54	15.12	8.27	—	—	—	—	—	—	—	—	—	—	—	—
K402	2.36	—	—	—	3.86	14.21	7.36	3.31	14.33	7.44	2.56	16.97	7.44	2.36	17.28	7.56	—	—	—
K403	.91	2.87	15.24	9.06	2.40	15.91	9.06	—	—	—	—	—	—	—	—	—	—	—	—
K513	.59	—	—	—	3.66	13.62	6.77	3.11	13.74	6.85	2.36	16.38	6.85	2.17	16.69	6.97	—	—	—
K514	.59	4.13	14.65	8.46	3.66	15.31	8.46	—	—	—	—	—	—	—	—	—	—	—	—
K613	.71	—	—	—	—	—	—	4.17	14.49	7.60	3.43	17.13	7.60	3.23	17.44	7.72	3.23	19.88	8.27
K614	.71	5.20	15.39	9.21	4.72	16.06	9.21	—	—	—	—	—	—	—	—	—	—	—	—
K713	.79	—	—	—	—	—	—	4.96	15.59	8.70	4.21	18.23	8.70	4.02	18.54	8.82	4.02	20.94	9.33
K714	.79	5.98	16.54	10.35	5.51	17.20	10.35	4.96	18.03	11.14	4.21	20.67	11.14	—	—	—	—	—	—
K813	.94	—	—	—	—	—	—	—	—	—	6.14	19.25	9.72	5.94	19.53	9.80	5.94	21.93	10.31
K814	.94	—	—	—	—	—	—	6.89	19.02	12.13	6.14	21.65	12.13	—	—	—	—	—	—
K913	.98	—	—	—	—	—	—	—	—	—	—	—	—	7.87	21.30	11.57	7.87	23.70	12.09
K914	.98	—	—	—	—	—	—	8.82	20.79	13.90	8.07	23.43	13.90	7.87	24.09	14.37	—	—	—
K1013	1.10	—	—	—	—	—	—	—	—	—	—	—	—	—	—	—	10.11	14.25	15.43
K1014	1.10	—	—	—	—	—	—	—	—	—	—	—	—	10.11	12.16	17.72	10.11	14.25	18.70

⁽³⁾ Also available for a NEMA 143TC frame motor.

Table No. 5 "K" Series with ComTrac – Approximate Weight (lbs.)

Part Number	K102	K202	K302	K303	K402	K403	K513	K514	K613	K614	K713	K714	K813	K814	K913	K914	K1013	K1014
TD270K050⁽²⁾	64	73	100	106	—	133	—	142	—	210	—	267	—	—	—	—	—	—
TD370K140	82	91	118	124	144	151	157	160	—	228	—	285	—	—	—	—	—	—
TD470K180	—	99	126	—	152	—	165	—	229	—	280	293	—	390	—	589	—	—
TD570K180	—	—	155	—	181	—	184	—	258	—	309	322	397	410	—	618	—	—
TD670K210	—	—	—	—	223	—	236	—	300	—	351	—	439	—	638	660	—	1123
TD760K210	—	—	—	—	—	—	—	—	364	—	415	—	503	—	702	—	1107	1187

⁽²⁾ Also available as TD270K140 for a NEMA 143TC frame motor.

MGs® Adjustable Speed Drives Lubrication and Mounting Information



Mounting Hollow Output Reducers

A STÖBER hollow output reducer can be mounted from either side. The tolerance for the hollow bore is shown in Table No. 1 and the shaft should be toleranced to fit this bore accordingly.

Table No. 1 Hollow Output Bore Tolerance

Bore Range	Tolerance	Bore Range	Tolerance
.39 – .71	+0.007/-0.000	1.97 – 3.15	+0.012/-0.000
.71 – 1.18	+0.008/-0.000	3.15 & UP	+0.014/-0.000
1.18 – 1.97	+0.010/-0.000		

A keeper plate inside the quill is provided with each unit to prevent axial movement. This keeper plate is held in place with snap rings and can be easily removed for location on either end. A spring pin in the keeper plate mounts into the keyway of the quill and prevents rotation. The keeper plate center hole is tapped to fit the removal bolt.

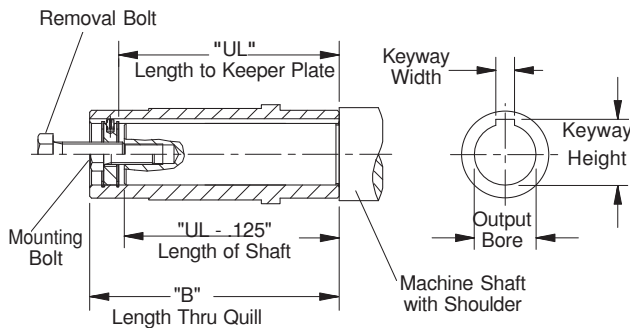

Before installation, brush the inside of the quill with rust inhibiting grease. When mounting the unit onto the shaft, avoid hammering as this may damage the bearings. Do not mount the reducer dry as removal may be impossible.

The drawing above shows a mounting or fixing bolt and a removal bolt. The mounting/fixing bolt should be smaller in size than the removal bolt. See Table No. 4.

To use the keeper plate with a mounting/fixing bolt, drill and tap the end of the shaft that will be mounted into the reducer. Insert the mounting/fixing bolt through the keeper plate and thread into the shaft end. The machine shaft length should not be longer than the "UL" dimension. A shaft length of "UL minus .125" inches will allow the shaft shoulder to pull against the face of the quill of the reducer.

Table No. 2 "UL" Dimension and Removal Bolt Size

Unit	Bore	UL	Bolt	Unit	Bore	UL	Bolt
F1	.750	2.67	3/8-16 NC	K3	1.375	4.92	5/8-11 NC
F2	1.000	3.62	1/2-13 NC	K4	1.500	6.18	3/4-10 NC
F3	1.250	4.06	1/2-13 NC	K5	2.000	6.46	3/4-10 NC
F4	1.500	4.49	3/4-10 NC	K6	2.000	7.05	3/4-10 NC
F6	2.000	5.63	3/4-10 NC	K7	2.375	8.43	1-8 NC
				K8	2.750	10.35	1-8 NC
K1	1.000	3.86	1/2-13 NC	K9	3.250	11.89	1-8 NC
K2	1.187	4.78	1/2-13 NC	K10	4.000	14.25	1 1/4-7NC

Removal of Hollow Output Reducers

To dismantle the unit from the shaft, remove the mounting bolt. Thread the removal bolt into the keeper plate to press against the shaft and loosen the shaft from the unit. Removal of the reducer will be easier if the quill is greased before installation. See our web site (www.stober.com) for a parts breakdown of a specific reducer or call STÖBER Customer Service.

In order to obtain long life and trouble-free operation from your MGS speed reducer, it is essential that recommended installation and operating procedures be followed.

Included here are directions for mounting and start-up of the MGS unit, as well as lubrication and maintenance instructions. Failure to follow these instructions will void the drive's warranty.

The torque required by the application must not exceed the reducer torque capacity shown on the nameplate. For safety purposes a safety coupling should be installed between the reducer and the driven load. Otherwise, overload may cause damage to the interior parts of the reducer which may result in breaking the reducer housing. As a result, persons could be injured by flying parts or splashing hot gear oil.

If you have questions about the installation, operation or maintenance of your MGS unit, please contact your local Stober distributor for assistance.

WARNING:

Safety is the most important consideration when operating any type of drive. Through proper application, safe handling methods, and wearing appropriate clothing, you can prevent accidents and injury to yourself and fellow workers.

The shafts of MGS speed reducers rotate at very high speeds and can cut off or severely injure hands, fingers, and arms. Use appropriate guards for shafts and other rotating parts at all times. Follow all directions in the service instruction manual. Obey all federal, state and local safety regulations when operating the drive.

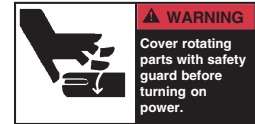

- Always be sure electrical power is off while making electrical connections and during installation and maintenance of the unit.
- Keep clothing, hands, and tools away from ventilation openings on motors and from all rotating parts during operation.
- Lift drive with a double rope sling or other proper lifting equipment of adequate strength. Make sure load is secured and balanced to prevent shifting when unit is being moved. Lifting drives by hand may be dangerous and should be avoided.
- The intended use of lifting lugs is to handle the weight of the unit only. Never use a lifting lug to lift attached assemblies.
- Never operate drive at speeds higher than those shown on the nameplate, or personal injury may result. Contact Stober Drives Inc., if there is any change of operating conditions from those for which the unit was originally sold (as stamped on the nameplate). Failure to comply could result in personal injury and or machinery damage.
- Always follow good safety practices at all times.

Each drive is tested before delivery. Before installation, however, it is advisable to examine the unit for possible damage which might have occurred during transit. If damage is discovered, it should be immediately reported to the transport agent.

If installation is delayed after receipt of the MGS speed reducer, the drive should be stored in a clean, dry place until put into service. Long term storage requires special procedures. If not kept in a heated, dry area, consult Stober Drives, Inc. for storage instructions.

NOTE: If it is necessary to clean drive shafts, take care to protect the oil seals.

IMPORTANT: Do not use any device to hammer the unit onto the output shaft during installation since the bearing races could be damaged.



MGs® Adjustable Speed Drives Lubrication and Mounting Information

Lubrication and Mounting Position

All STOBER units are shipped filled with the required amount of lubrication. In order to provide the proper lubrication quantity the mounting position required should be specified at the time of order. **No unit will be shipped without the mounting position specified by the customer.**

Vertical mounting may require different seals, bearings, etc. so it is very important to mount the unit in the position for which it was assembled.

Table No. 1 shows standard lubricant characteristics.

Table No. 1

Characteristic of STOBER Standard Lubricants

	Exxon		
	MobilGear XP600	Special Mist EP220 Food Grade	Mobilgear SHC630
Anti-Foaming Additives	X	X	Excellent
Corrosion Protection	X	X	Optimum
Extreme Pressure Additives	X	X	X
Friction and Wear			
Reducing Characteristics	X	X	Superior
Oxidation Protection	X	X	Enhanced
Wide Temperature Range			X

If food grade or synthetic oil is requested, it will be Mobilgear Special Mist EP220 food grade or Mobilgear SHC630 synthetic.

Maintenance

With STOBER reducers very little maintenance is required under normal operating conditions.

Breathers are provided on the following units:

C612 through C913

K513 through K1014

See Table No. 2 and 3 for location of drain and vent for each series and mounting position.

We recommend that the lubrication be changed in units supplied with breathers according to the following schedule:

Normal Operating Conditions after 5000 Hours

Wet Operating Conditions after 2000 Hours.

Units supplied without breathers are lubricated for life.

Some motor manufacturers provide a drain hole in the mounting face of washdown motors. Be sure this hole is covered during washing or when the unit is used in a wet environment.

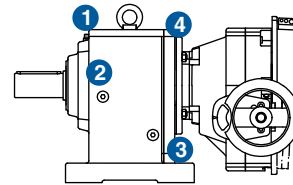

Table No. 2 Drain Plug and Vent Location

Mounting Position	1	2	2a	3	4
EL1	Vent			Drain	
EL2	Drain			Vent	
EL3		Vent			
EL4		Drain			
EL5(C612-C912)	Drain		Drain		
EL5(C613-C913)	Drain		Vent		Vent
EL6	Vent			Drain	

Position 2a is on the opposite side of 2.

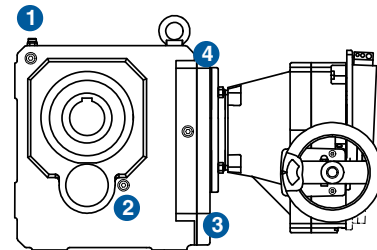

Table No. 4 Drain Plug and Vent Location

Mounting Position	1	2	2a	3	4
EL1	Vent			Drain	
EL2	Drain			Vent	
EL3		Vent			
EL4		Drain			
EL5(K513/K1013)	Drain		Drain		
EL5(K514/K1014)	Drain		Vent		Vent
EL6(K513/K1013)	Vent			Drain	
EL6(K513/K1014)	Vent				Drain

Position 2a is on the opposite side of 2.

MGs® Adjustable Speed Drives Mounting Information



Mounting position must be specified when the order is placed.

ComTrac Location

The position of the ComTrac and the handwheel location can be specified at the time of assembly.

Specify by ComTrac position **I** thru **IV** with handwheel **L** (left) or **R** (right).

IV is the standard position – with the handwheel on the left (**L**) as shown.

If no specification is made, units will be shipped **with the standard position**.

Table No. 1 "C" Series – Mounting Position

EL1	EL2	EL3	EL4	EL5	EL6
Side 1	Side 2	Side 3	Side 4	Side 5	Side 6

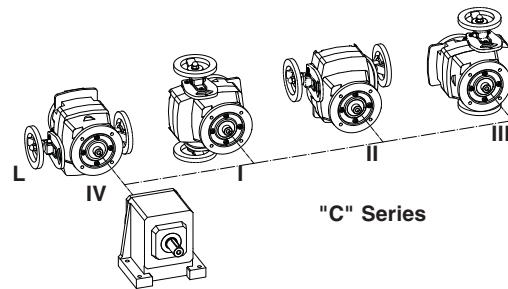
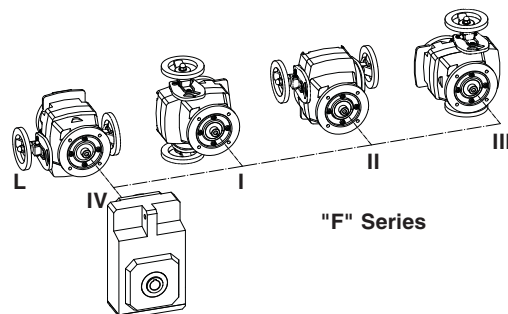

Table No. 2 "F" Series – Mounting Position

EL1	EL2	EL3	EL4	EL5	EL6
Side 1	Side 2	Side 3	Side 4	Side 5	Side 6





MGS® Adjustable Speed Drives

Mounting Information

Mounting position must be specified when the order is placed.

Table No. 3 "K1-K4" Series – Mounting Position

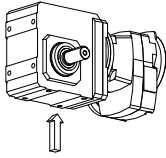
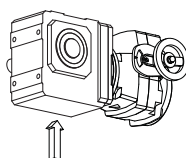
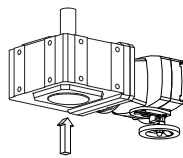
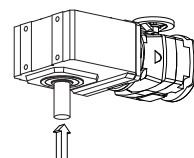
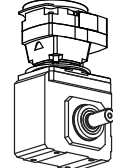
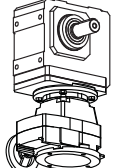
EL1	EL2	EL3	EL4	EL5	EL6
					
Side 1	Side 2	Side 3	Side 4	Side 5	Side 6

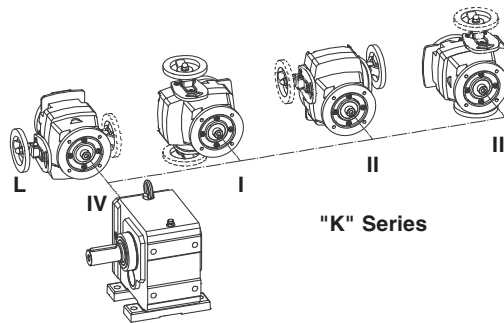
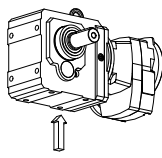
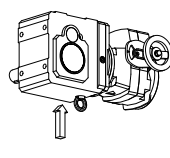
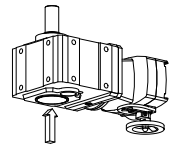
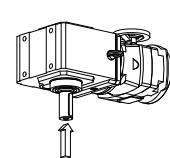
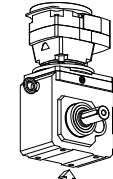
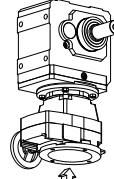

Table No. 4 "K5-K10" Series – Mounting Position

EL1	EL2	EL3	EL4	EL5	EL6
					
Side 1	Side 2	Side 3	Side 4	Side 5	Side 6

Terms and Conditions of Sale



1. **GENERAL.** All orders for products supplied by STÖBER DRIVES INC. ("STÖBER") shall be subject to these terms and conditions of sales. All transactions shall be governed by the laws of the Commonwealth of Kentucky. No modifications hereto will be binding unless agreed to in writing by STÖBER.

2. **CUSTOMER.** The term "Customer," as used herein, means the distributor, resale dealer, original equipment manufacturer or first end-user customer that purchases the STÖBER products.

3. **WARRANTY.** STÖBER products shall be free from defects in material and workmanship for a maximum of 5-years (single shift operation or 30 months multiple shift operation) for ServoFit products and MGS Long Life products; 3-years (single shift operation or 18 months multiple shift operation) for MGS products; 2-years (single shift operation or 12 months multiple shift operation) for TD products, from the date of shipment to the Customer. For ServoFit products, all normal wear items, including oil seals and bearings, shall be covered for a period of 2-years (single shift operation or 12 months multiple shift operation). In the event that a product proves to be defective, STÖBER's sole obligation shall be, at its option, to repair or replace the product. The repaired or replacement product will be shipped F.O.B. STÖBER's facilities, freight prepaid by STÖBER.

No employee, agent or representative of STÖBER has the authority to waive, alter, vary or add to the terms hereof without the prior written approval of an officer of STÖBER. It is expressly agreed that (a) this section constitutes the final expression of the parties' understanding with respect to the warranty and (b) this section is a complete and exclusive statement of the terms of the warranty.

STÖBER shall have no obligation under the warranty set forth above in the event that:

- The Customer fails, within the warranty period to notify STÖBER in writing and provide STÖBER with evidence satisfactory to STÖBER of the alleged defect within five (5) days after it becomes known to the customer;
- After inspection of a product, STÖBER determines, in its sole discretion, that it is not defective in material or workmanship;
- Repair or replacement of a product is required through normal wear and tear;
- Any part in a product or any ingredient contained in a product requires replacement or repair through routine usage or normal wear and tear;
- A product is not maintained or used in accordance with STÖBER's applicable operating and/or maintenance manuals, whether by the Customer or any third party;
- A product has been subject to misuse, misapplication, negligence, neglect (including, but not limited to, improper maintenance or storage), accident, catastrophe, improper installation, modification, adjustment, repair or lubrication, whether by the Customer or any third party, without the prior written consent of STÖBER. Misuse shall include, but not be limited to, deterioration in a product due to chemical action and wear caused by the presence of abrasive materials;
- The system of connected rotating parts into which the product becomes incorporated is not compatible with the product, or it is not free from critical speed or torsional or other type of vibration within the specified operating range, no matter how induced; or
- The transmitted load and imposed torsional thrust and overhung loads are not within the published capacity limits for the unit sold.

Items manufactured by other parties but installed in or affixed to STÖBER's products are not warranted by STÖBER and bear only those warranties, express or implied, which are given by the manufacturer of such items, if any.

THE WARRANTY SET FORTH ABOVE IS INTENDED SOLELY FOR THE BENEFIT OF THE Customer AND

DOES NOT APPLY TO ANY THIRD PARTY. ALL CLAIMS MUST BE MADE BY THE Customer AND MAY NOT BE MADE BY ANY THIRD PARTY. THIS WARRANTY MAY NOT BE TRANSFERRED OR ASSIGNED, IN WHOLE OR IN PART, BY THE Customer FOR ANY REASON WHATSOEVER. ANY SUCH ATTEMPTED TRANSFER OR ASSIGNMENT SHALL BE NULL AND VOID.

THIS WARRANTY TAKES THE PLACE OF ALL OTHER WARRANTIES, EXPRESS OR IMPLIED, WHICH ARE HEREBY DISCLAIMED AND EXCLUDED BY STÖBER, INCLUDING WITHOUT LIMITATION, ANY WARRANTY OF MERCHANTABILITY OR FITNESS FOR A PARTICULAR PURPOSE OF USE AND ALL OBLIGATIONS OR LIABILITIES ON THE PART OF STÖBER FOR DAMAGES ARISING OUT OF OR IN CONNECTION WITH THE USE, REPAIR OR PERFORMANCE OF THE PRODUCTS.

4. **MODIFICATIONS.** STÖBER reserves the right, without notice to the Customer, to (a) change the specifications of any product, (b) improve a product in any manner that STÖBER deems necessary or appropriate and (c) discontinue the manufacture of any product.

5. **PURCHASE ORDERS.** The Customer will submit purchase orders for the products to STÖBER in writing, whether by mail or telefax, which shall set forth, at a minimum: (a) an identification of the products ordered, (b) prices for such products, (c) quantities, (d) requested delivery dates and (e) shipping instructions and shipping addresses.

6. **ACCEPTANCE OF ORDERS.** All purchase orders received from the Customer are subject to acceptance by STÖBER in writing.

7. **MODIFICATION OF ORDERS.** No accepted purchase order shall be modified or canceled except upon the written agreement of STÖBER and the Customer. Mutually agreed cancellations shall be subject to reasonable charges based upon expenses already incurred by STÖBER and commitments made by STÖBER. Mutually agreed change orders shall be subject to all provisions of these Terms and Conditions of Sale.

8. **PRICE INCREASES.** STÖBER may increase its prices for the products by providing the original purchaser of the products with at least thirty (30) days' prior written notice. Increased prices for products shall not apply to purchase orders accepted prior to the effective date of the price increase unless such orders provide for delivery more than thirty (30) days after the date of acceptance of the order.

9. **PRICING AND DELIVERY TERMS.** In accordance with KRS 355.2-319(1)(b), all products are delivered F.O.B. STÖBER's warehouse facility in Maysville, Kentucky, or such other facility as STÖBER may designate. Orders are then shipped per Customer's shipping instructions as set forth in Customer's purchase order. **CATALOG PRICING DOES NOT INCLUDE SHIPPING, HANDLING AND TAXES.** Once delivered to a common carrier of the Customer's choosing [or of STÖBER's choosing if Customer has failed to specify a common carrier on or before five (5) days prior to the requested delivery date] STÖBER shall have no further responsibility for the products and all risk of damage, loss or delay shall pass to the Customer. A handling fee is added to freight costs by STÖBER to cover the cost of having to pay the carrier within seven (7) days when the terms with the Customer are net 30. The Customer has the option of shipping collect with our carrier or the carrier of choice.

10. **PAYMENT TERMS.** Net 30 days. All orders will be shipped either prepaid by the Customer or C.O.D., at STÖBER's option, unless the Customer has established a previously approved credit line. If STÖBER approves a credit line for the Customer, all payments shall be due within thirty (30) days of the date of the invoice. If any invoice is not paid in full within such thirty (30) day period, then finance charges shall be

assessed at the rate of one and one-half percent (1½%) per month (eighteen percent (18%) per year). If such rate is deemed to be usurious at any time, it shall be reduced to the maximum rate permitted by applicable law. STÖBER may stop or withhold shipment of products if the Customer does not fulfill its payment obligations. If STÖBER is insecure about payment for any reason, STÖBER may require full or partial payment in advance and as a condition to the continuation of its delivery of products.

11. **SECURITY INTEREST.** Unless and until the products are paid for in full, STÖBER reserves a security interest in them to secure the unpaid balance of the purchase price. The Customer hereby grants to STÖBER a power of attorney, coupled with an interest, to execute and file on behalf of the Customer all necessary financing statements and other documents required or appropriate to protect the security interest granted herein.

12. **ACCEPTANCE OF PRODUCTS.** The Customer will conduct any incoming inspection tests as soon as possible upon arrival of the products, but in no event later than ten (10) days after the date of receipt. Any products not rejected by written notice to STÖBER within such period shall be deemed accepted by the Customer. STÖBER shall not be liable for any additional costs, expenses or damages incurred by the Customer, directly or indirectly, as a result of any shortage, damage or discrepancy in a shipment.

13. **LIMITATION OF REMEDIES.**

- STÖBER SHALL NOT BE LIABLE FOR ANY LOSS OR DAMAGE CAUSED BY DELAY IN FURNISHING THE CUSTOMER WITH PRODUCTS.
- IN NO EVENT SHALL STÖBER'S LIABILITY INCLUDE ANY SPECIAL, INDIRECT, INCIDENTAL OR CONSEQUENTIAL LOSSES OR DAMAGES, EVEN IF STÖBER HAS BEEN ADVISED OF THE POSSIBILITY OF SUCH POTENTIAL LOSS OR DAMAGE.

14. **MADE-TO-ORDER PRODUCTS.** STÖBER reserves the right to revoke and amend any price quotations offered to the Customer for made-to-order products, provided that such price quotations have not been accepted by the Customer prior to the date of revocation or amendment.

15. **DIES, TOOLS AND EQUIPMENT.** Charges incurred by the Customer for dies, tools and other equipment shall not confer ownership or the right to possession therein by the Customer. All such dies, tools and equipment shall remain the property of STÖBER, and STÖBER shall have the exclusive right to possession thereof. STÖBER shall maintain such tools and equipment in good working order.

16. **REGULATORY LAWS AND STANDARDS.** STÖBER makes no representation that its products conform to state or local laws, ordinances, regulations, codes or standards except as may be otherwise agreed to in writing by STÖBER.

17. **SIZES AND WEIGHTS.** STÖBER's products are made only in the sizes and to the specifications set forth in its catalogs and other literature. If any alteration is requested, such altered product will be treated as a made-to-order item. STÖBER assumes no responsibility for typographical errors which may appear in its catalogs or literature, and cannot accept alteration charges caused by such errors. Since weights shown in STÖBER's catalogs are approximate, they cannot be used in determining freight allowances set forth in its catalogs and other literature. Freight allowances will be determined at the time of shipment and shall be based on actual shipping weight.

18. **SYSTEM DESIGN.** Responsibility for system design to ensure proper use and application of STÖBER's products within their published specifications and ratings rests solely with the Customer. This includes, but is not limited to, an analysis of loads created by torsional vibrations within the entire system, regardless of how induced.



Stöber International

maintenance manuals

Keeping you connected

Technical Support

Austria
STÖBER ANTRIEBSTECHNIK GmbH
Fabrikplatz 1
4600
Pho
Fax
E-Mail

Belg
VAR
Gen
909
Pho
Fax

Bra
Ch
M
R
040
Pho
Fax
E-Mail

Can
Z
10
Pho
Fax
E-Mail

Chi
000
Gen
Un
8
Ch
Pho
Fax
E-Mail

Col
SC
App
San
Fin
Tel
Fax

Den
ST

Stober Drives Inc.

Location: <http://www.stober.com/>

Request Info. Stober Advantage About Stober Contact Us Support Industries

Motion Control ServoFit Planetary Gearheads "P" Series Planetary "PA" Series Planetary "PH" Series Planetary "PHA" Series Planetary "PE" Series Planetary "PKX" Series Planetary "PHKX" Series Planetary ServoFit™ Modular System "C" Series Concentric Helical "F" Series Offset Helical "K" Series Right Angle Helical/Bevel		Power Transmission Food Duty "NEW" Supreme "KE" "K" Series Right Angle Helical/Bevel "F" Series Offset Helical "C" Series Concentric Helical Beverage Duty "K" Series Right Angle Helical/Bevel "C" Series Concentric Helical MGS Speed Reducers "C" Series Concentric Helical "F" Series Offset Helical "K" Series Right Angle Helical/Bevel "S" Series Right Angle Helical/Worm ComTrac Adjustable Speed Drives EASY Reducer Selection
---	---	---

Standard 3-Day Delivery
Standard delivery - 3 days or less
Emergency - 24 hours, no expedite fee

NEW - 5 YEAR LONG LIFE WARRANTY

Beverage and Food Duty
Robust solutions that excel in demanding applications and under the harshest washdown environments.

Search

1781 Downing Drive Maysville, KY 41056 Phone: (606) 750-5090 or (800) 711-3588 Fax: 1-888-4-STOBER (786237) Email: sales@stober.com
STOBER Partner Login: info.stober.com

All material © Copyright 2004 STOBER Drives Inc.
MGS™, SMS™, STOBER™, ServoFit™, TriAdapt™, HeliCamber™, the STOBER Logo™, and ComTrac™ are trademarks of STOBER Drives, Inc.

Stober EASY drive selection program

Catalogs on-line

Stober VALUE program

CAD files

parts lists

Tech Support

Our web site is just one of the ways we bring you new solutions to constant and adjustable speed drive problems.

Please visit us online.
www.stober.com

Sleeve

Motor C

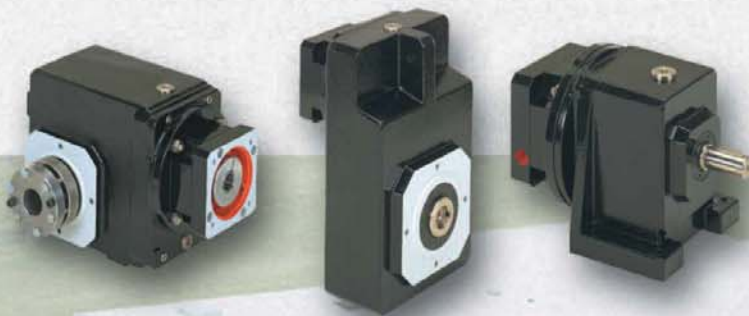

ServoFit Modular System - SMS Gearheads



STOBER Drives Inc.
Maysville, Kentucky

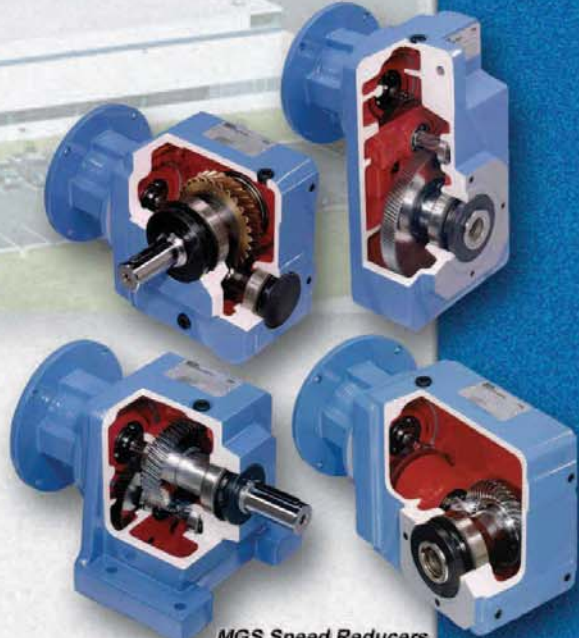

MGS Speed Reducers



MGS Food and Beverage Duty Reducers



STÖBER Antriebstechnik
Pforzheim, Germany



SPG - ServoFit Precision Planetary Gearheads

STOBER Drives, Inc.
1781 Downing Drive, Maysville KY 41056
Phone: 606 759-5090, FAX: 606 759-5045, Toll Free: 800 711-3588
Web: www.stober.com, E-mail: sales@stober.com

ComTrac™, MGS™, Stober™, and ServoFit™ are registered trademarks of STOBER Drives, Inc.
TD, Copyright June 2007, Printed in U.S.A.

