

THK

NEW

Slide Pack Stainless Steel Series

FBW2560XR/ 3590XR/ 50110XR



THK CO., LTD.
TOKYO, JAPAN

CATALOG No.338-1E

Slide Pack Stainless Steel Series

FBW-XR

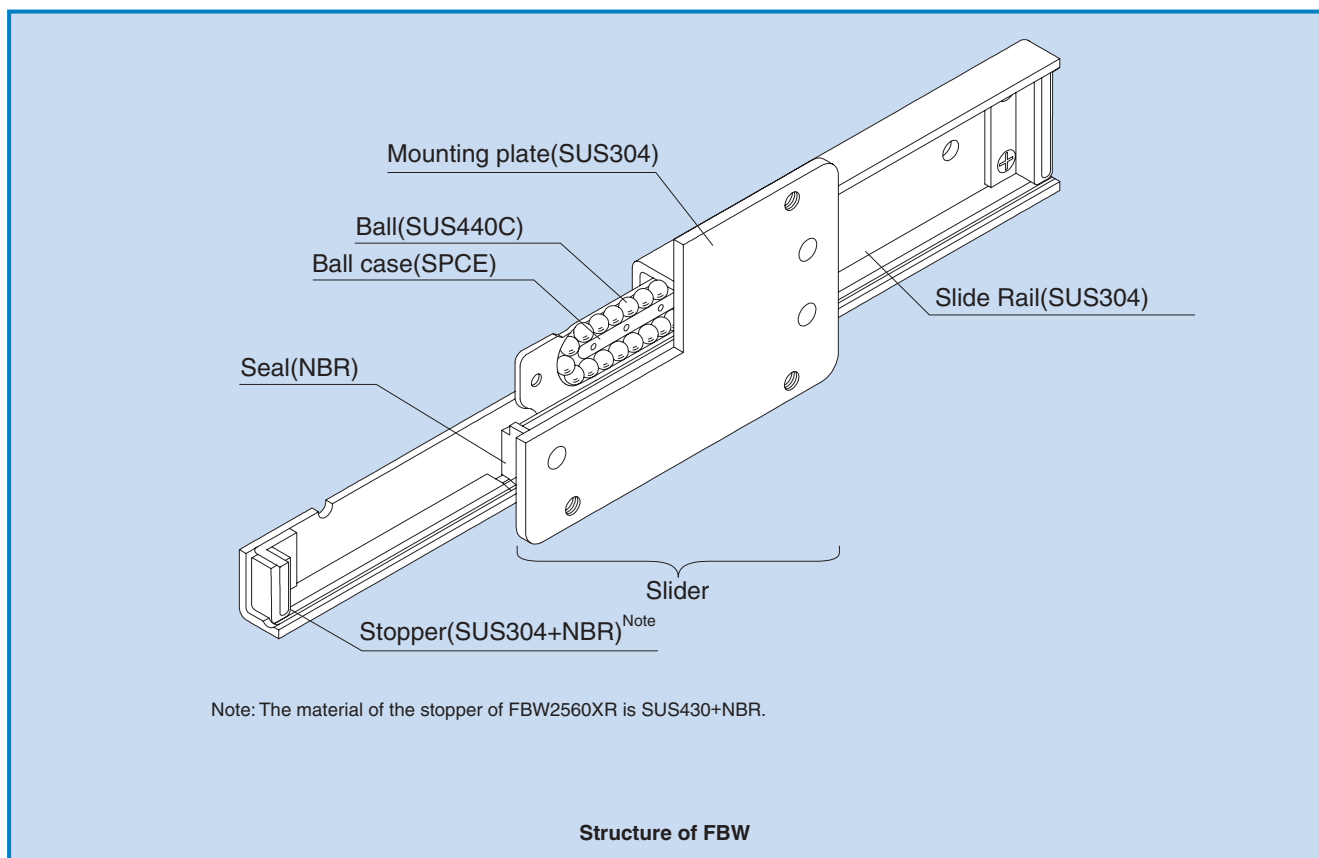

● High Corrosion Resistance

Parts such as the rail, mounting plate and stopper are made of austenitic stainless steel to achieve high corrosion resistance.

● High Rigidity

FBW3590XR and FBW50110XR have thicker rails to achieve higher rigidities than conventional models.

● Rigidity Test Data

● Low Noise

FBW2560XR, FBW3590XR and FBW50110XR have newly designed sliders to decrease noise level by 5dBA from the conventional models.

(in the case of model FBW3590XR at velocity 60 m/min)

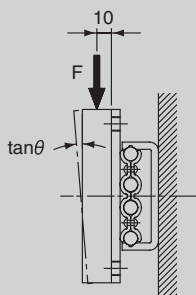

Vertical direction load

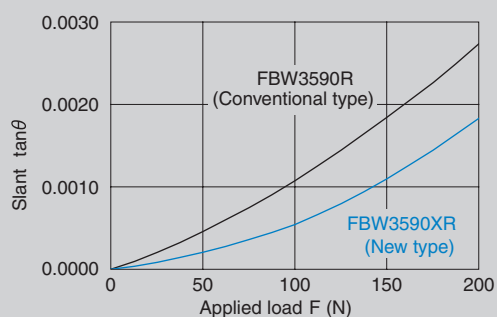

Clearance

Model FBW-XR is manufactured to the following accuracies.

Vertical direction: 0.03 mm or less

Lateral direction: 0.1 mm or less

These specification values apply when the slide rail is attached to a rigid base.

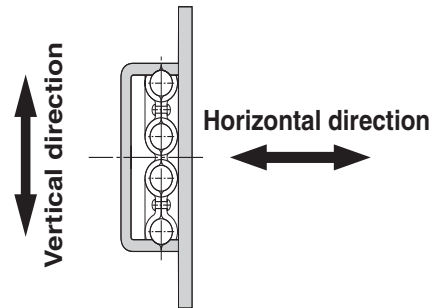

Mounting Screws of the Slide Rail

Since the space for securing the mounting screws of the slide rail is limited, shown in the figure below, we recommend using button-head or binding-head bolts (JIS B 1111 annex).

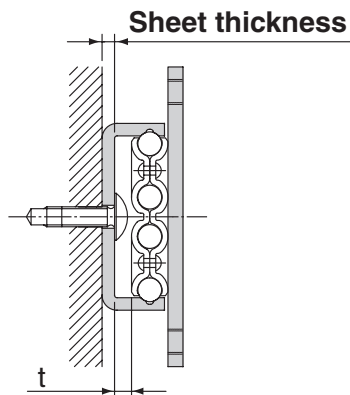

Unit: mm

Model No.	Sheet thickness	t
FBW 2560XR	1.5	3.2
FBW 3590XR	2.5	3.4
FBW 50110XR	2.5	3.4

Note: FBW3590XR and FBW50110XR have thicker rails than the conventional models (3590R and 50110R) by 0.2 mm.

Groove Dimensions

The table on the right shows the groove dimensions for model FBW-XR when it is used in a groove.

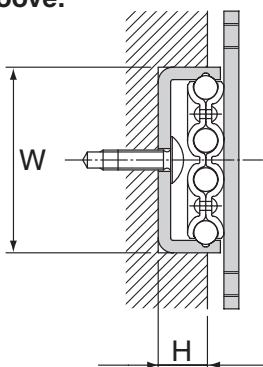

Unit: mm

Model No.	W	H
FBW 2560XR	24.8 ^{+0.15} / _{+0.1}	7.4
FBW 3590XR	37.4 ^{+0.15} / _{+0.1}	10
FBW 50110XR	50.4 ^{+0.15} / _{+0.1}	10

Note: FBW3590XR and FBW50110XR require greater groove widths than the conventional models (3590R and 50110R) by 0.4 mm.

FBW2560XR TYPE

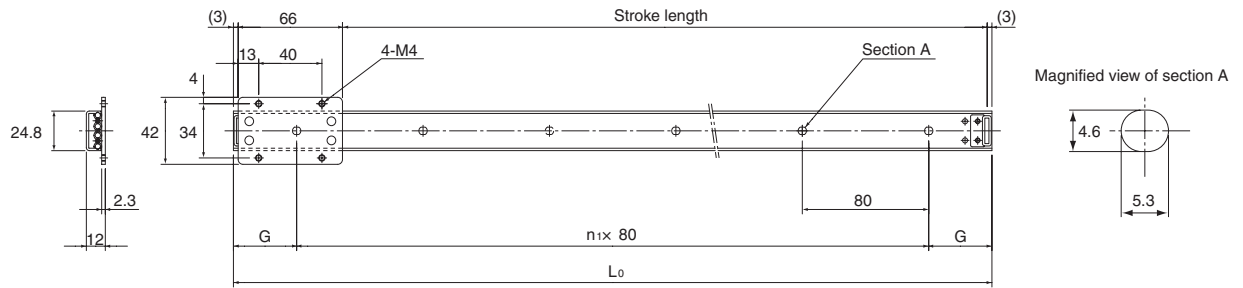

FBW3590XR TYPE

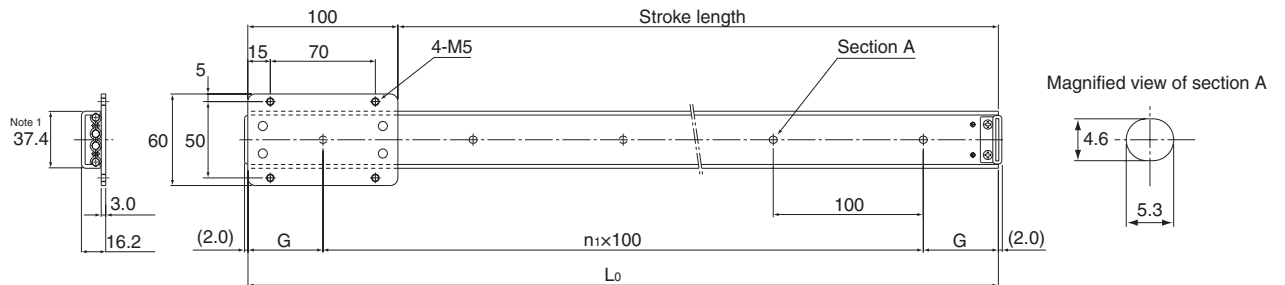

[FBW2560XR]

Unit: mm

Slide rail length L_0	Main dimensions		Stroke length		Slide rail mass [g] <small>Note2</small>
	n_1	G	Without seal	With seal	
160	1	40	88	83	70
240	2	40	168	163	110
320	3	40	248	243	140
400	4	40	328	323	180
480	5	40	408	403	210
560	6	40	488	483	250
640	7	40	568	563	290
720	8	40	648	643	320
800	9	40	728	723	360
880	10	40	808	803	390
960	11	40	888	883	430
1040	12	40	968	963	460
1200	14	40	1128	1123	540

[FBW3590XR]

Unit: mm

Slide rail length L_0	Main dimensions		Stroke length		Slide rail mass [g] <small>Note2</small>
	n_1	G	Without seal	With seal	
300	2	50	200	195	280
350	3	25	250	245	330
400	3	50	300	295	380
450	4	25	350	345	420
500	4	50	400	395	470
550	5	25	450	445	520
600	5	50	500	495	560
650	6	25	550	545	610
700	6	50	600	595	650
750	7	25	650	645	710
800	7	50	700	695	750
900	8	50	800	795	850
1000	9	50	900	895	930
1200	11	50	1100	1095	1090
1500	14	50	1400	1395	1410
1800	17	50	1700	1695	1740

Note 1: The rail width is greater than the conventional model by 0.4 mm.

Note 2: Slider mass is 70[g] for FBW2560XR, and 250[g] for FBW3590XR.

Note 3: A model equipped with a dust cover is also available. Contact THK for details.

Note 4: Quality lithium soap based grease is applied to the slider and the ball circulation area.

Model number coding

2 **FBW3590XR** **UU** **+800L** **- T**

Model No.
Rail length
Symbol for rail jointed use

No. of sliders
(no symbol for a single slider)
With seal (no symbol for without seal)

FBW50110XR TYPE

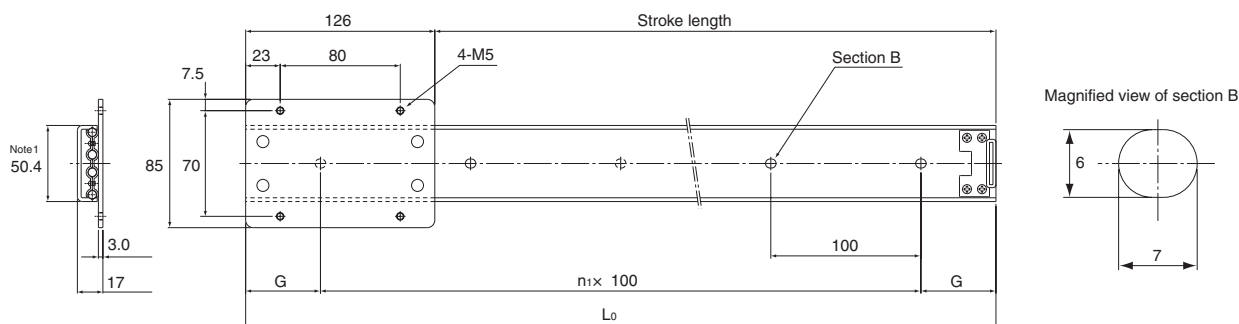

[FBW50110XR]

Unit: mm

Slide rail length L_0	Main dimensions		Stroke length		Slide rail mass [g]
	n_1	G	Without seal	With seal	
300	2	50	170	164	390
350	3	25	220	214	460
400	3	50	270	264	520
450	4	25	320	314	590
500	4	50	370	364	650
600	5	50	470	464	780
700	6	50	570	564	910
800	7	50	670	664	1040
900	8	50	770	764	1190
1000	9	50	870	864	1300
1200	11	50	1070	1064	1520
1500	14	50	1370	1364	1950
1800	17	50	1670	1664	2380

Static Permissible Load

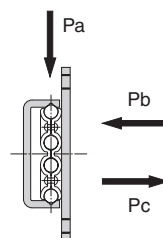

Unit: N

Model No.	Static permissible load		
	P_a	P_b	P_c
FBW 2560XR	590	150	70
FBW 3590XR	880	200	100
FBW 50110XR	1960	500	390

Note 1: The rail width is greater than the conventional model by 0.4 mm.

Note 2: Slider mass is 420[g] for FBW50110XR.

Note 3: A model equipped with a dust cover is also available. Contact THK for details.

Note 4: Quality lithium soap based grease is applied to the slider and the ball circulation area.

Model number coding

2 FBW50110XR UU +800L - T

Model No.
No. of sliders
(no symbol for a single slider)

Rail length
Symbol for rail jointed use
With seal (no symbol for without seal)

THK Slide Pack Stainless Steel Series

Precautions on Use

● Handling

- Do not disassemble components. This may cause dust to enter the system or degrade mounting accuracy of parts.
- Do not tilt the slider or slide rail. This may cause them to fall by their own weight.
- Do not drop or hit the Slide Pack. This may damage it or cause injuries. Impacting to the Slide Pack could also cause damage to its function even if the product looks intact.

● Lubrication

- We recommend using high-quality lithium-soap group grease No. 2. Do not mix lubricants of different physical properties.

● Precautions on Use

- Quality lithium soap based grease is applied to the slider and the ball circulation area.
- Take care that foreign material, such as dust or cutting chips, do not enter the system. This may cause damage to the ball circulating component or functional loss.
- If foreign material such as dust or cutting chips adheres to the product, replenish the lubricant after cleaning the product with pure white kerosene.
- Avoid using the product at other than normal temperature, or using it in harsh conditions such as intensive reciprocations that generate frictional heat and environments with water or dust.
- When using the Slide Pack with inverted mount, breakage of the slider due to an accident or the like may cause balls to fall and the slider to come off from the slide rail and fall. In these cases, take preventive measures such as adding a safety mechanism for preventing such falls.
- When removing the slider from the slide rail and then reassembling, inserting the slide rail into the slider while twisting may cause balls to fall or cause damage to the slider. Be sure to gently insert the rail straight into the slider while checking the position of the slider balls and that of the rail raceway.

● Storage

- When storing the Slide Pack, enclose it in a package designated by THK and store it while avoiding high temperature, low temperature and high humidity.

● "LM Guide", "Caged Ball" and " " are registered trademarks of THK CO., LTD.

- The actual products may differ slightly in appearance from the photos.
- The appearance and the specifications are subject to change for improvement without notice. Contact THK before placing an order.
- Although great care has been taken in the production of this catalog, THK will not take any responsibility for damage resulting from typographical errors or omissions.
- For the export of our products or technologies and for the sale for exports, THK in principle complies with the foreign exchange law and the Foreign Exchange and Foreign Trade Control Law as well as other relevant laws.
For export of THK products as single items, contact THK in advance.

All rights reserved.

THK CO., LTD.

HEAD OFFICE 3-11-6, NISHI-GOTANDA, SHINAGAWA-KU, TOKYO 141-8503 JAPAN
INTERNATIONAL SALES DEPARTMENT PHONE:+81-3-5434-0351 FAX:+81-3-5434-0353
Global site : <http://www.thk.com/>

NORTH AMERICA

THK America, Inc.

● HEADQUARTERS

Phone:+1-847-310-1111 Fax:+1-847-310-1271

● CHICAGO OFFICE

Phone:+1-847-310-1111 Fax:+1-847-310-1182

● NEW YORK OFFICE

Phone:+1-845-369-4035 Fax:+1-845-369-4909

● ATLANTA OFFICE

Phone:+1-770-840-7990 Fax:+1-770-840-7897

● LOS ANGELES OFFICE

Phone:+1-949-955-3145 Fax:+1-949-955-3149

● SAN FRANCISCO OFFICE

Phone:+1-925-455-8948 Fax:+1-925-455-8965

● BOSTON OFFICE

Phone:+1-781-575-1151 Fax:+1-781-575-9295

● DETROIT OFFICE

Phone:+1-248-858-9330 Fax:+1-248-858-9455

● TORONTO OFFICE

Phone:+1-905-820-7800 Fax:+1-905-820-7811

SOUTH AMERICA

THK Brasil LTDA

Phone:+55-11-3767-0100 Fax:+55-11-3767-0101

EUROPE

THK GmbH

● EUROPEAN HEADQUARTERS

Phone:+49-2102-7425-0 Fax:+49-2102-7425-217

● DÜSSELDORF OFFICE

Phone:+49-2102-7425-0 Fax:+49-2102-7425-299

● FRANKFURT OFFICE

Phone:+49-2102-7425-650 Fax:+49-2102-7425-699

● STUTTGART OFFICE

Phone:+49-7150-9199-0 Fax:+49-7150-9199-888

● MÜNCHEN OFFICE

Phone:+49-8937-0616-0 Fax:+49-8937-0616-26

● U.K. OFFICE

Phone:+44-1908-30-3050 Fax:+44-1908-30-3070

● ITALY MILANO OFFICE

Phone:+39-039-284-2079 Fax:+39-039-284-2527

● ITALY BOLOGNA OFFICE

Phone:+39-051-641-2211 Fax:+39-051-641-2230

● SWEDEN OFFICE

Phone:+46-8-445-7630 Fax:+46-8-445-7639

● AUSTRIA OFFICE

Phone:+43-7229-51400 Fax:+43-7229-51400-79

● SPAIN OFFICE

Phone:+34-93-652-5740 Fax:+34-93-652-5746

● TURKEY OFFICE

Phone:+90-216-362-4050 Fax:+90-216-569-7150

THK France S.A.S.

Phone:+33-4-3749-1400 Fax:+33-4-3749-1401

CHINA

THK (CHINA) CO., LTD.

● HEADQUARTERS

Phone:+86-411-8733-7111 Fax:+86-411-8733-7000

● SHANGHAI OFFICE

Phone:+86-21-6219-3000 Fax:+86-21-6219-9890

● BEIJING OFFICE

Phone:+86-10-8441-7277 Fax:+86-10-6590-3557

● CHENGDU OFFICE

Phone:+86-28-8526-8025 Fax:+86-28-8525-6357

● GUANGZHOU OFFICE

Phone:+86-20-8333-9770 Fax:+86-20-8333-9726

THK (SHANGHAI) CO., LTD.

Phone:+86-21-6275-5280 Fax:+86-21-6219-9890

TAIWAN

THK TAIWAN CO., LTD.

● TAIPEI HEAD OFFICE

Phone:+886-2-2888-3818 Fax:+886-2-2888-3819

● TAICHUNG OFFICE

Phone:+886-4-2359-1505 Fax:+886-4-2359-1506

● TAINAN OFFICE

Phone:+886-6-289-7668 Fax:+886-6-289-7669

KOREA

SEOUL REPRESENTATIVE OFFICE

Phone:+82-2-3468-4351 Fax:+82-2-3468-4353

SINGAPORE

THK LM SYSTEM Pte. Ltd.

Phone:+65-6884-5500 Fax:+65-6884-5550

INDIA

BANGALORE REPRESENTATIVE OFFICE

Phone:+91-80-2330-1524 Fax:+91-80-2314-8226

